

Trashday 01

Scene	Duration	Panel	Duration
1	05:28:03	1	01:00

TRASH
DAY

Scene	Duration	Panel	Duration
1	05:28:03	2	01:00

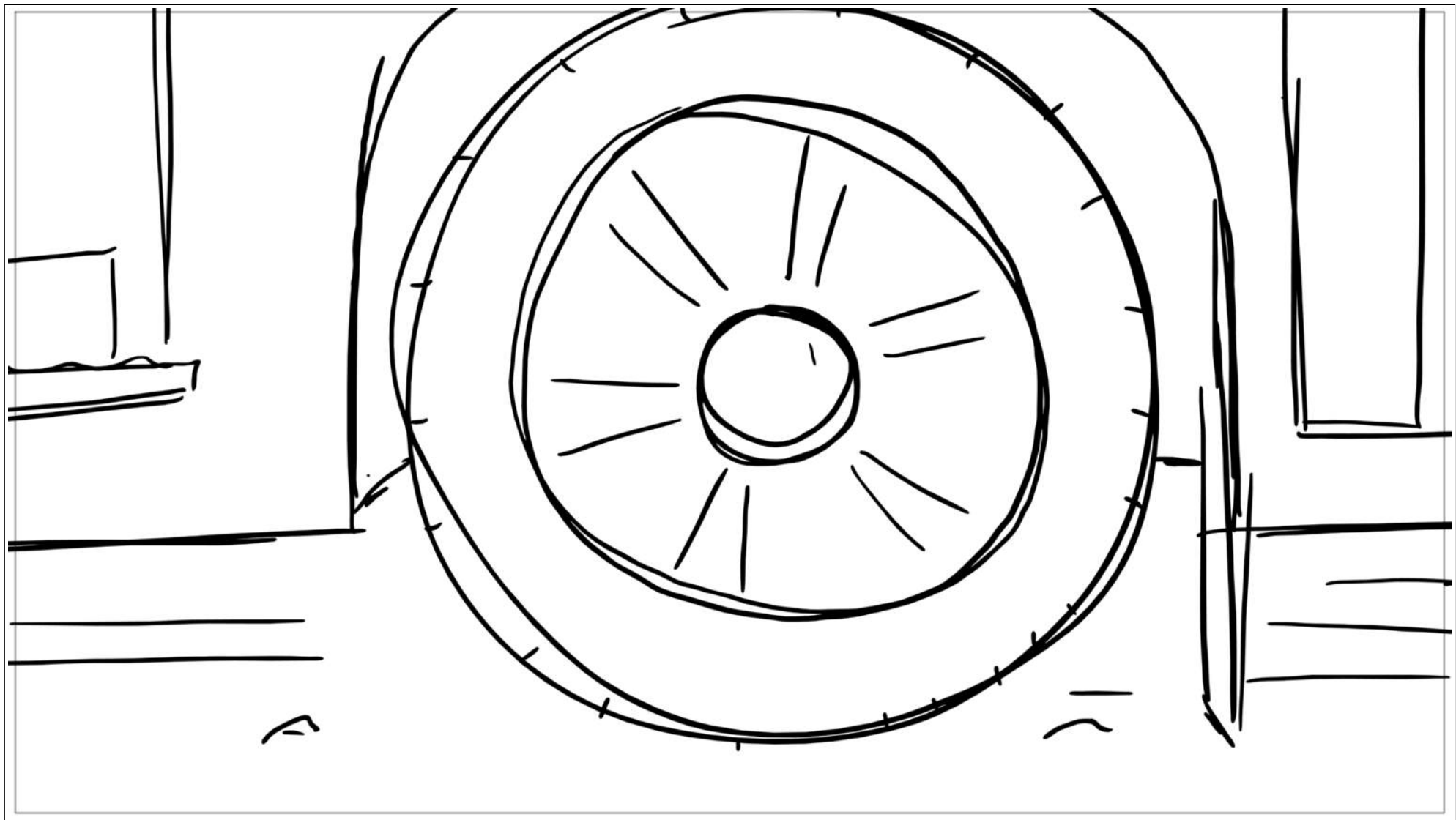

Scene	Duration	Panel	Duration
1	05:28:03	3	01:00

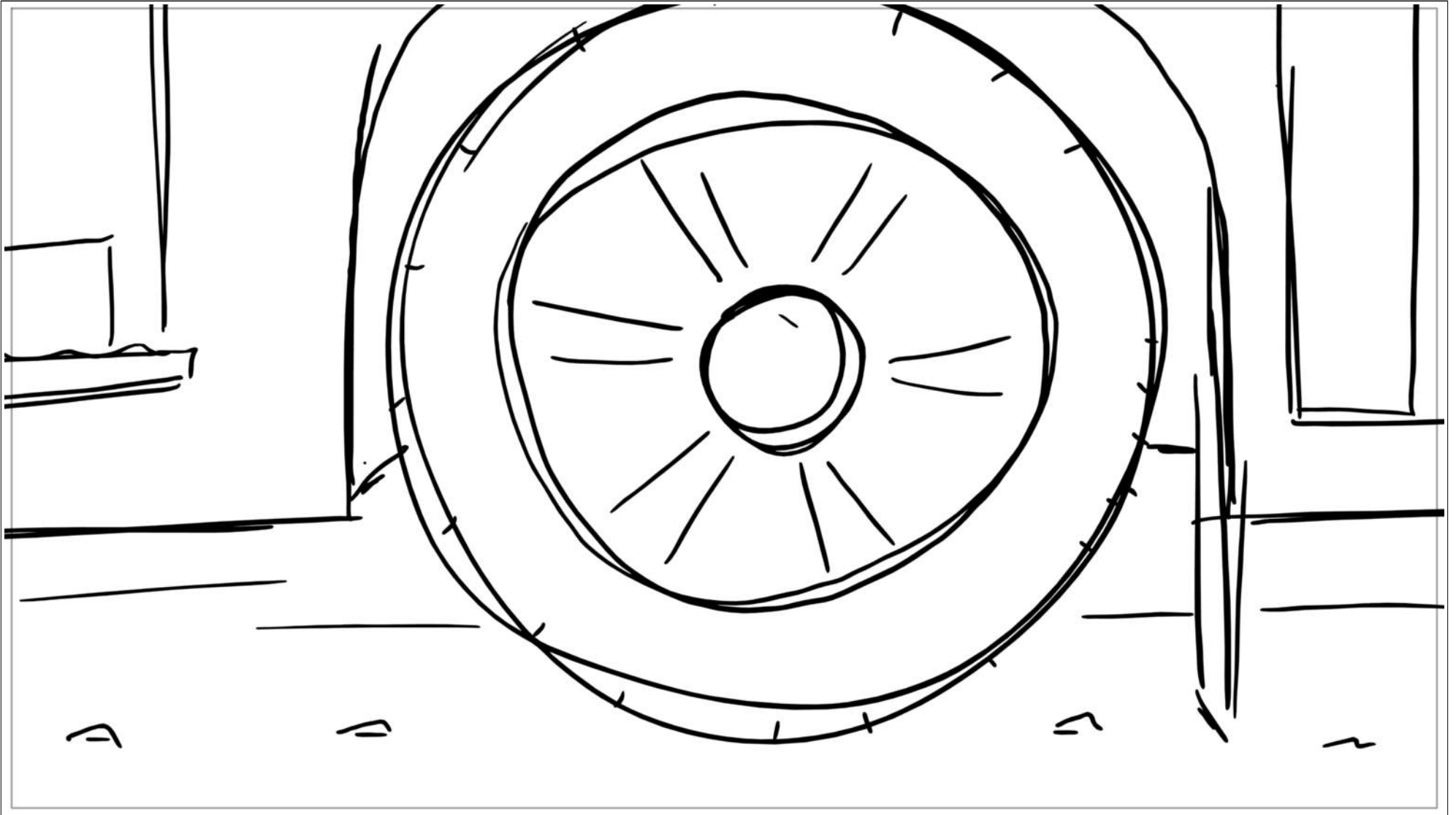

Scene	Duration	Panel	Duration
1	05:28:03	4	01:00

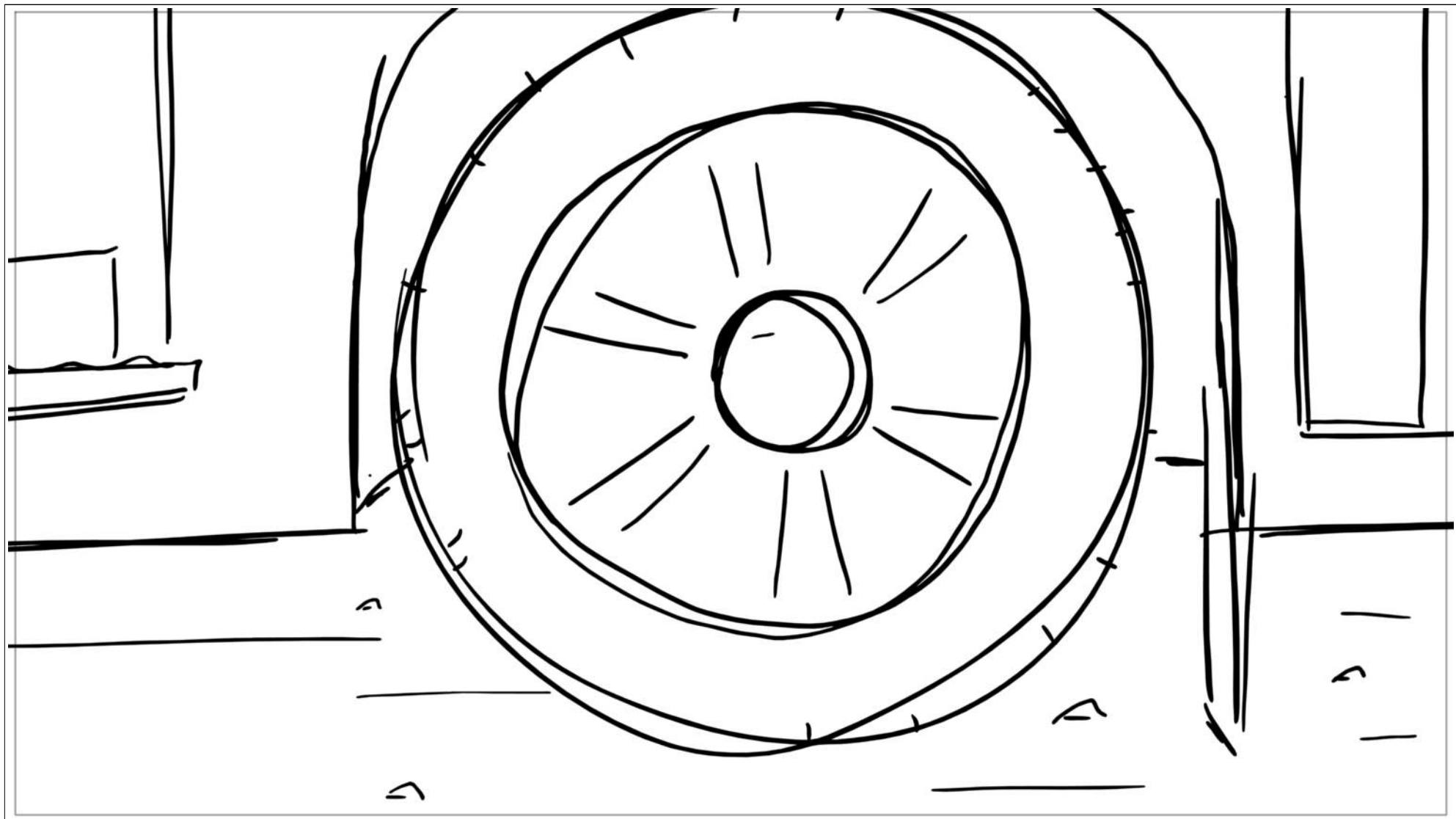

Scene	1	Duration	05:28:03	Panel	5	Duration	01:00
-------	---	----------	----------	-------	---	----------	-------

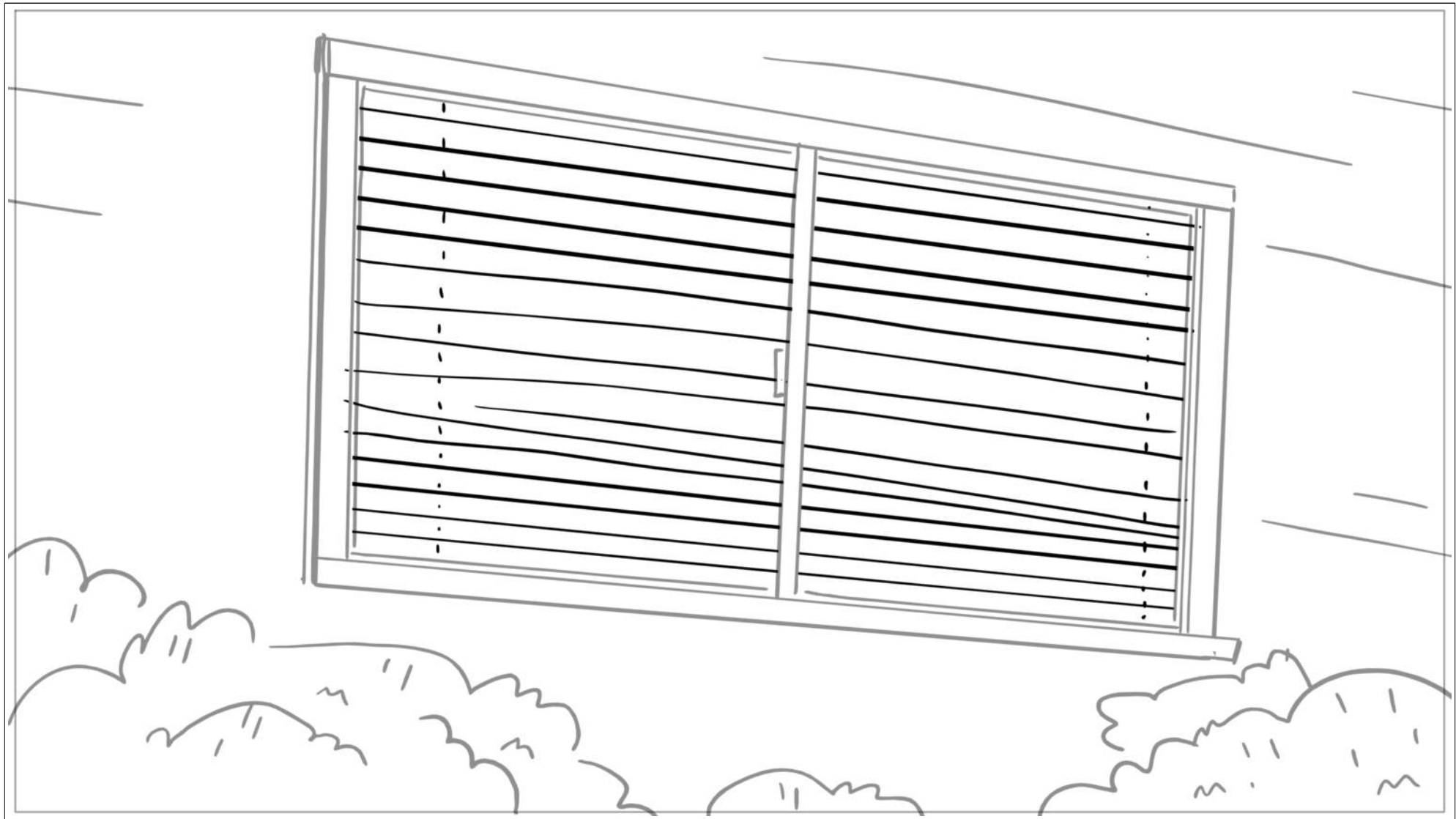

Scene	Duration	Panel	Duration
1	05:28:03	6	01:00

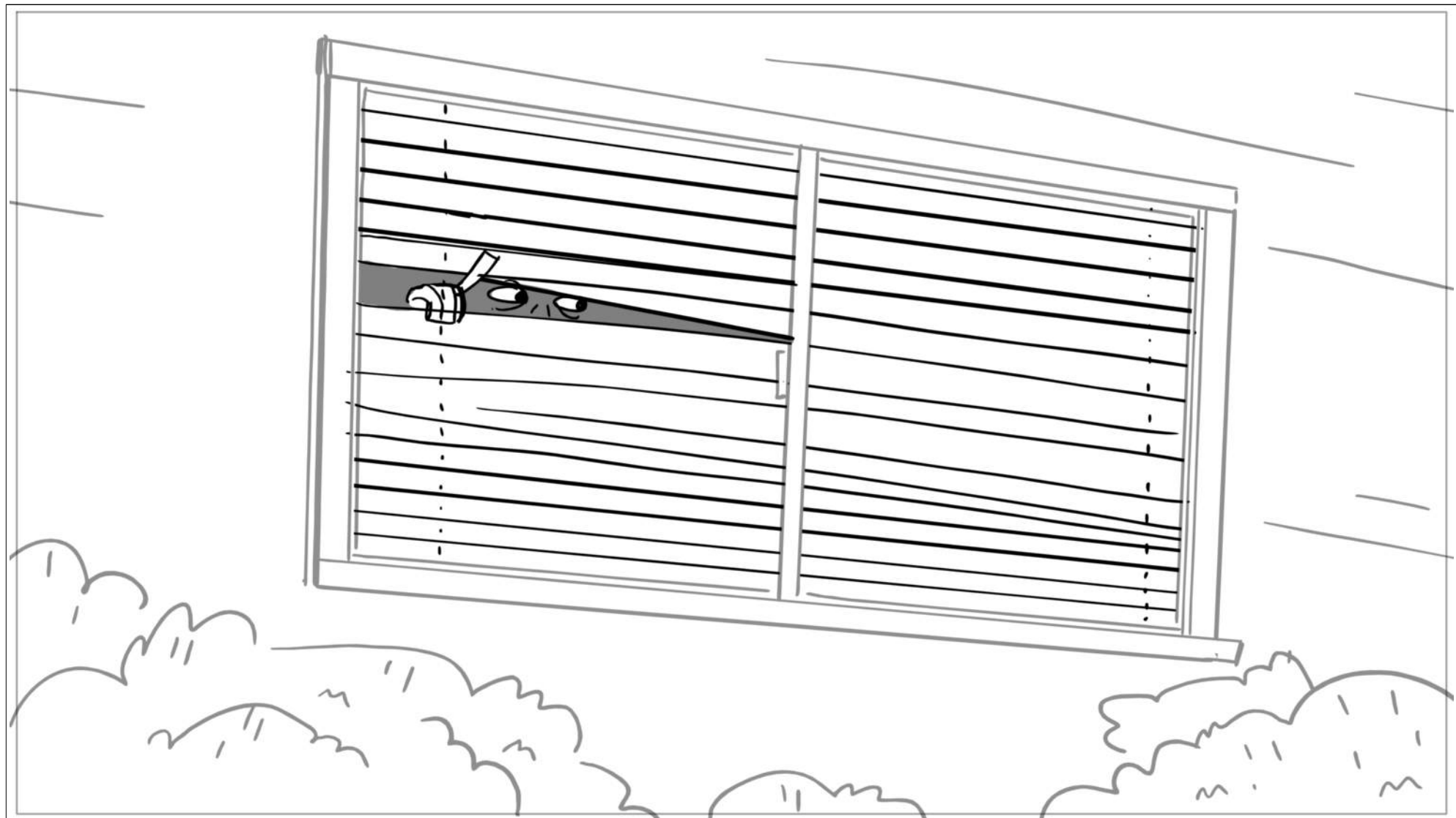

Scene	Duration	Panel	Duration
1	05:28:03	7	01:00

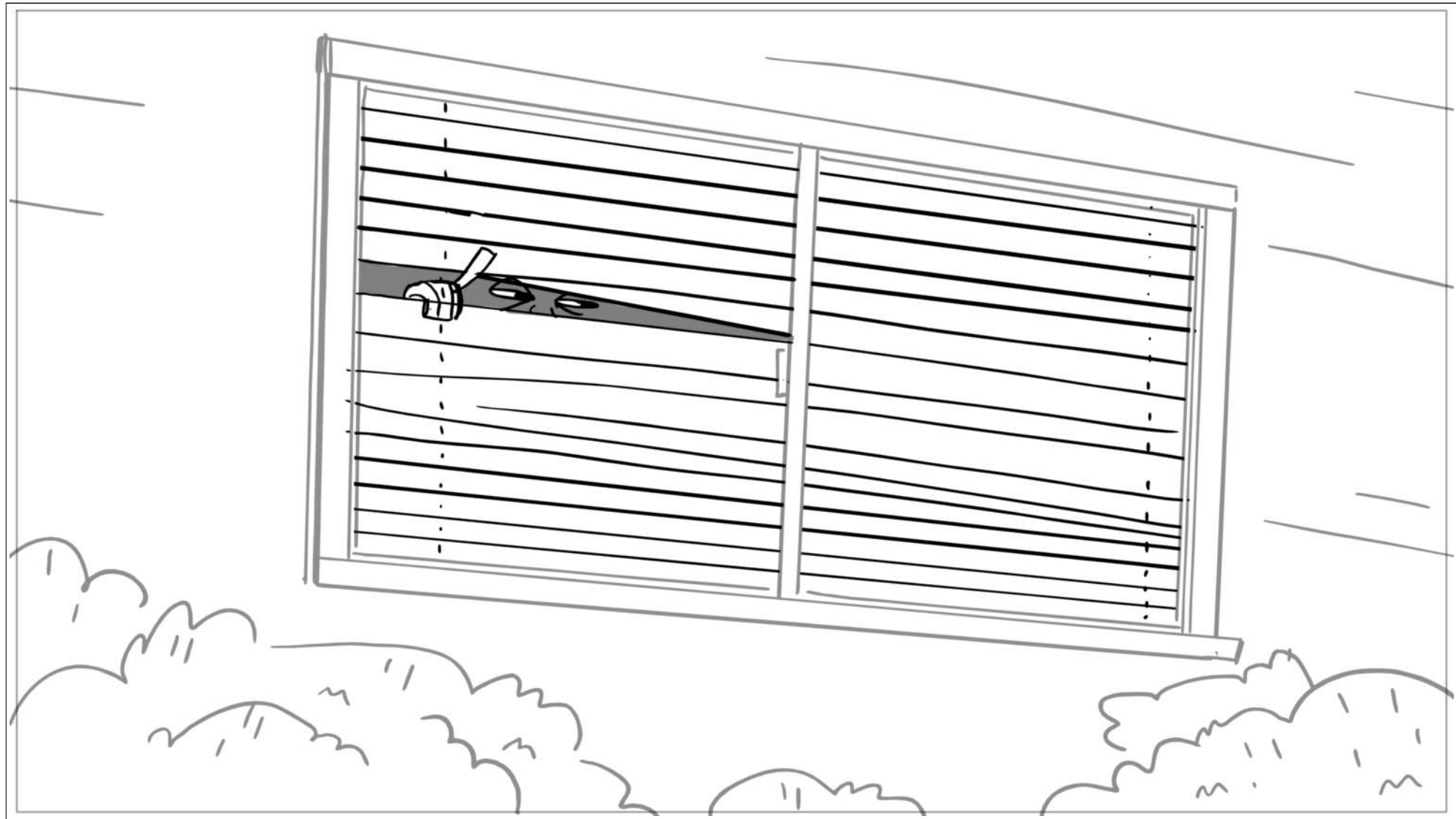

Scene	Duration	Panel	Duration
1	05:28:03	8	01:00

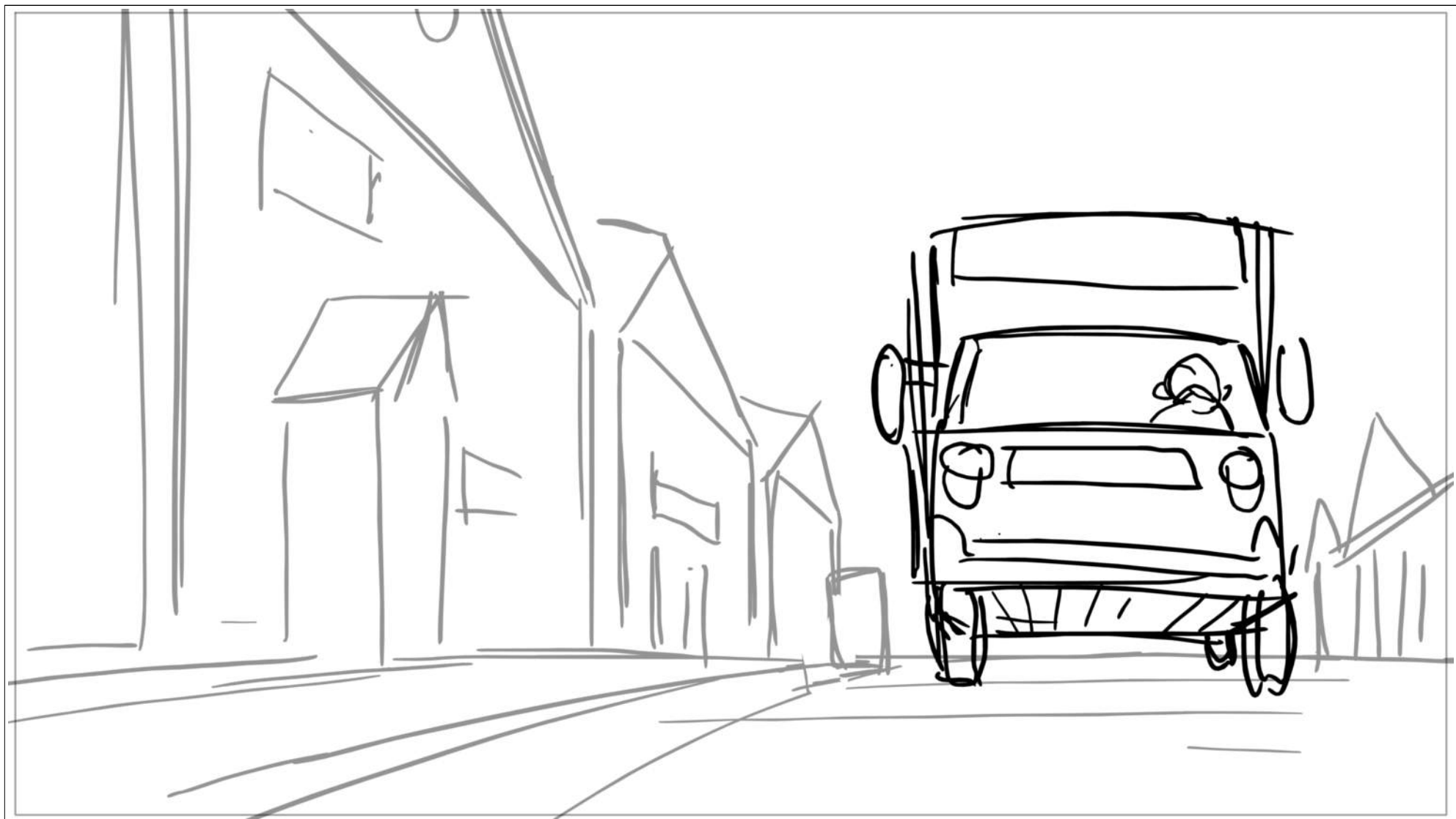

Scene	Duration	Panel	Duration
1	05:28:03	9	01:00

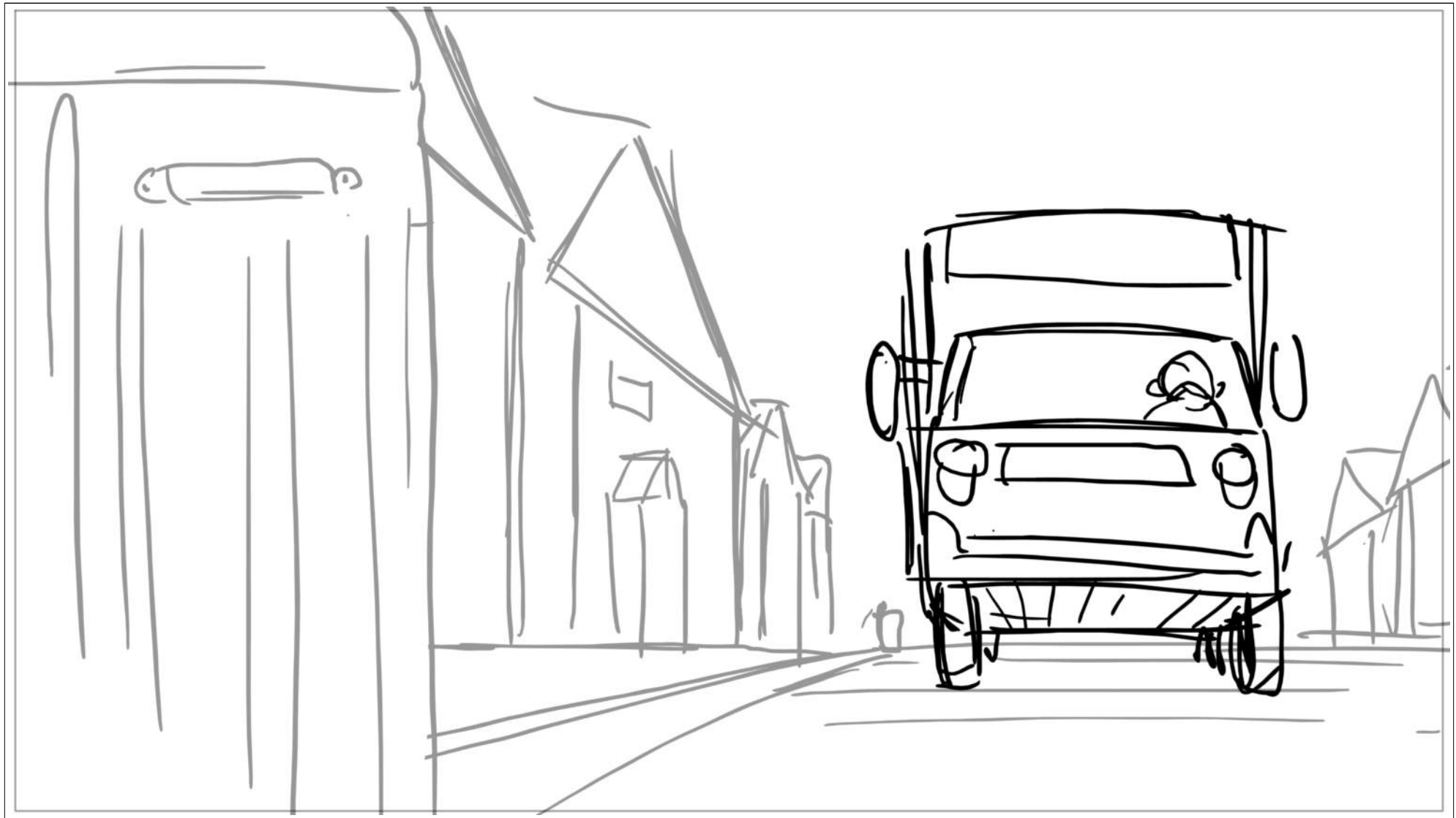

Scene	Duration	Panel	Duration
1	05:28:03	10	01:00

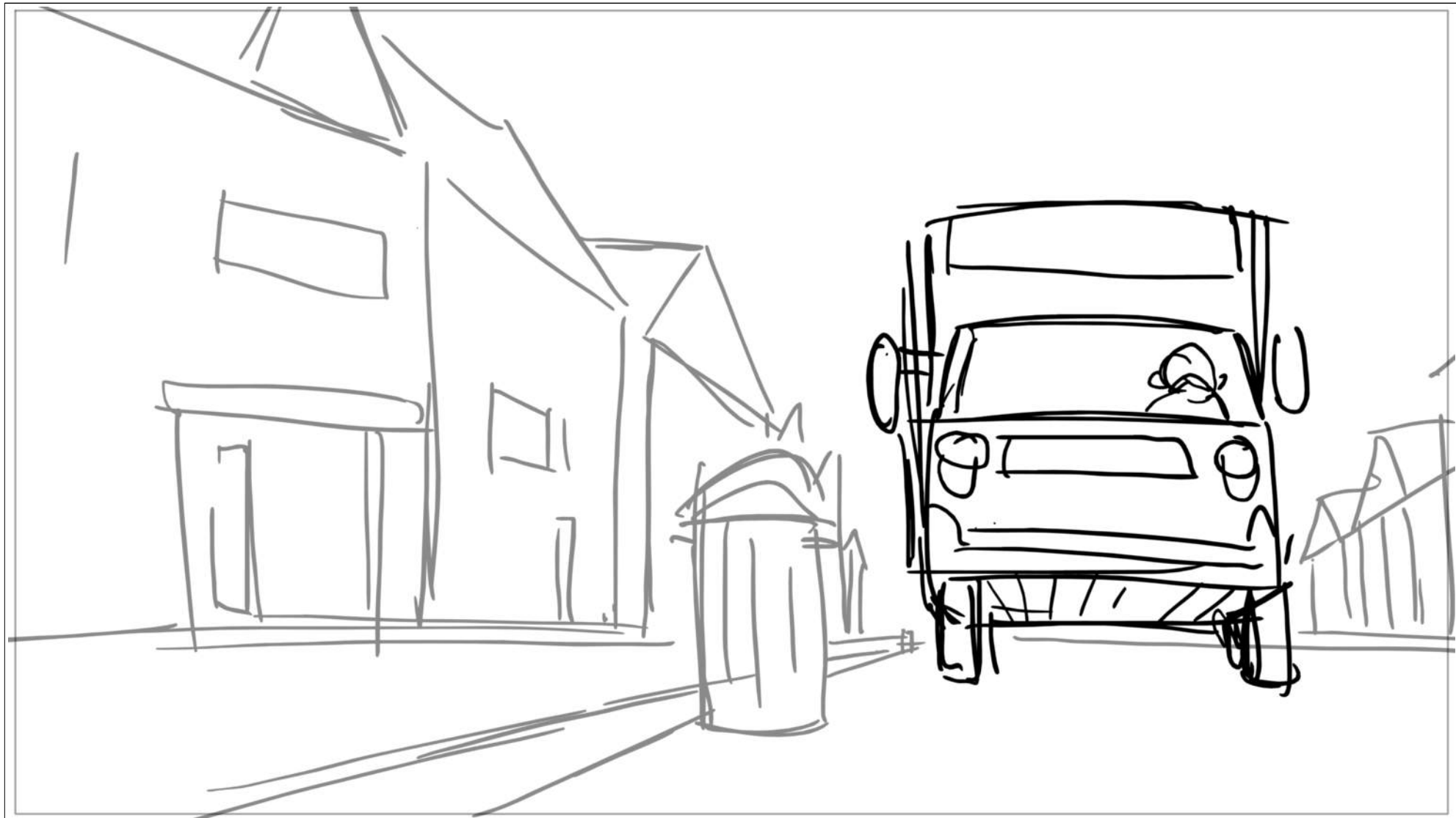

Scene	Duration	Panel	Duration
1	05:28:03	11	01:00

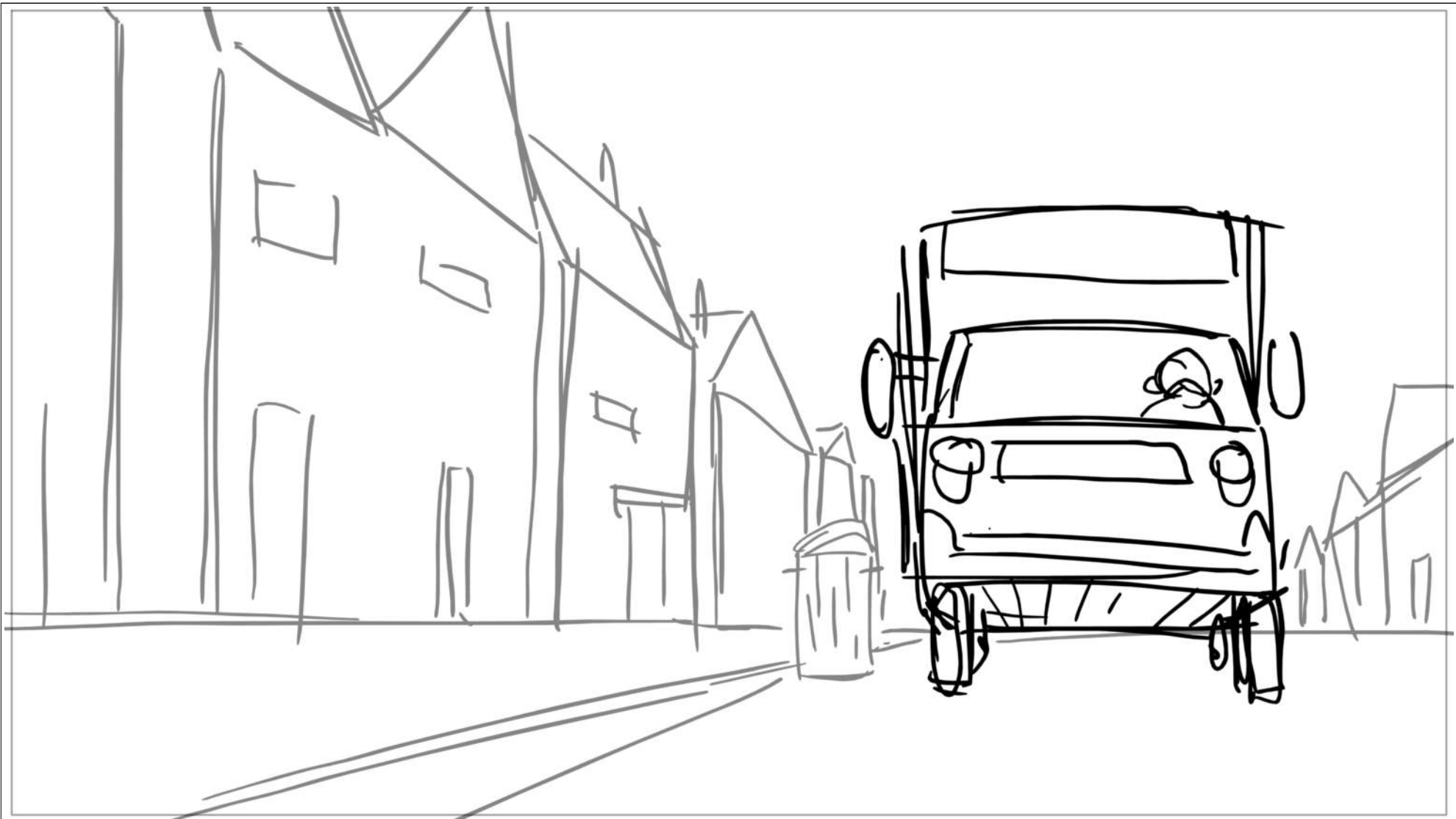

Scene	Duration	Panel	Duration
1	05:28:03	12	01:00

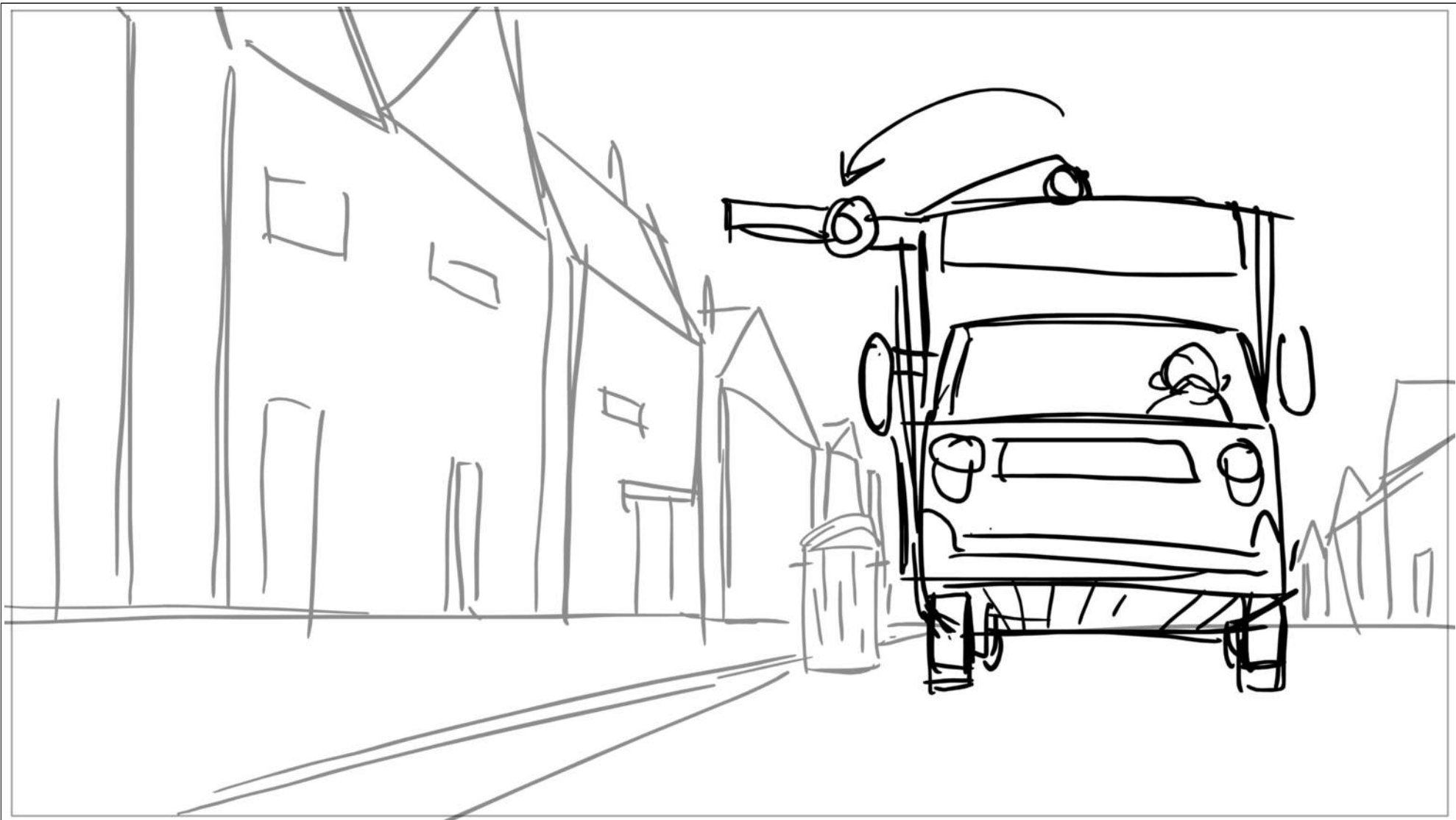

Scene	Duration	Panel	Duration
1	05:28:03	13	01:00

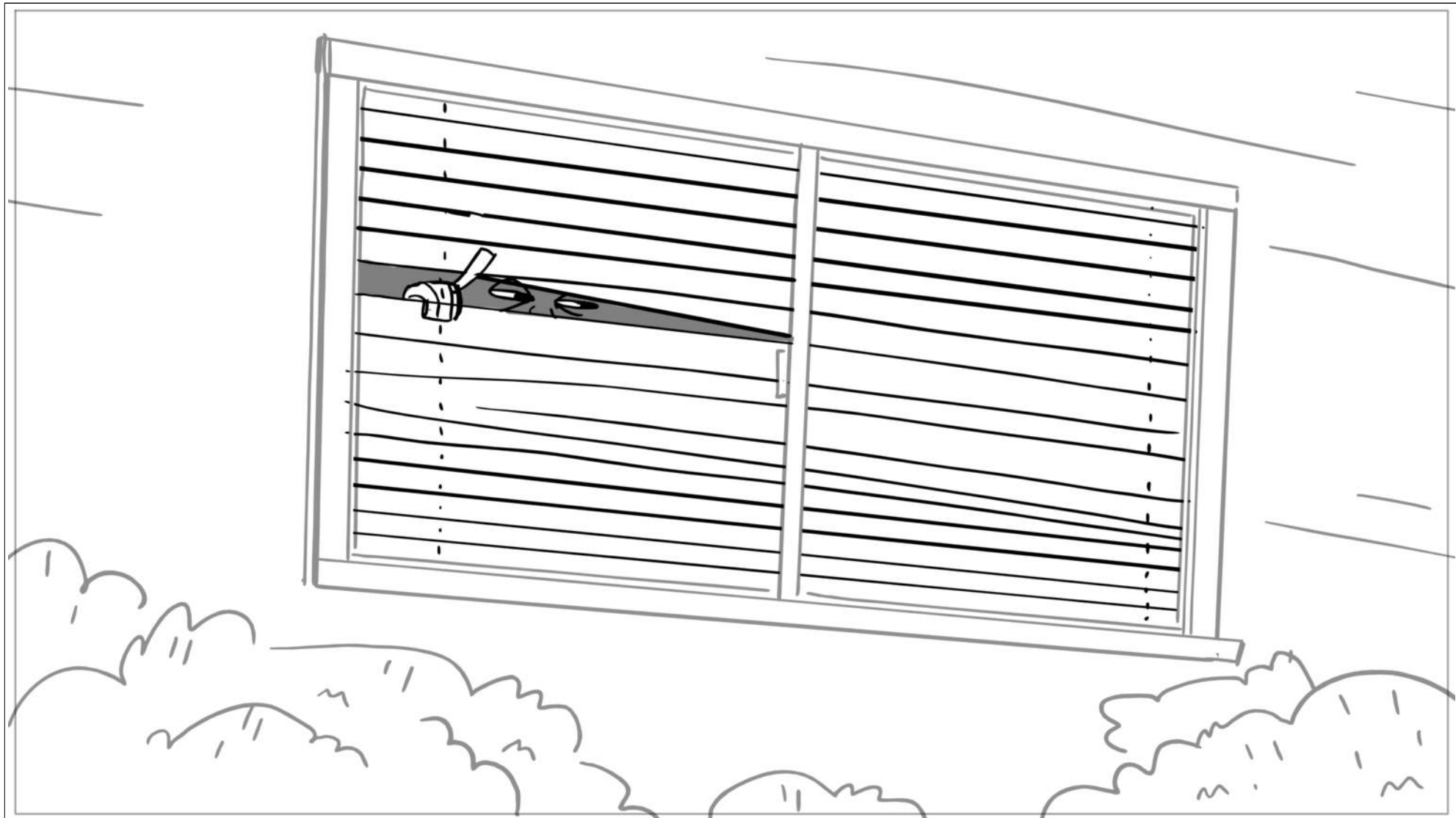

Scene	Duration	Panel	Duration
1	05:28:03	14	01:00

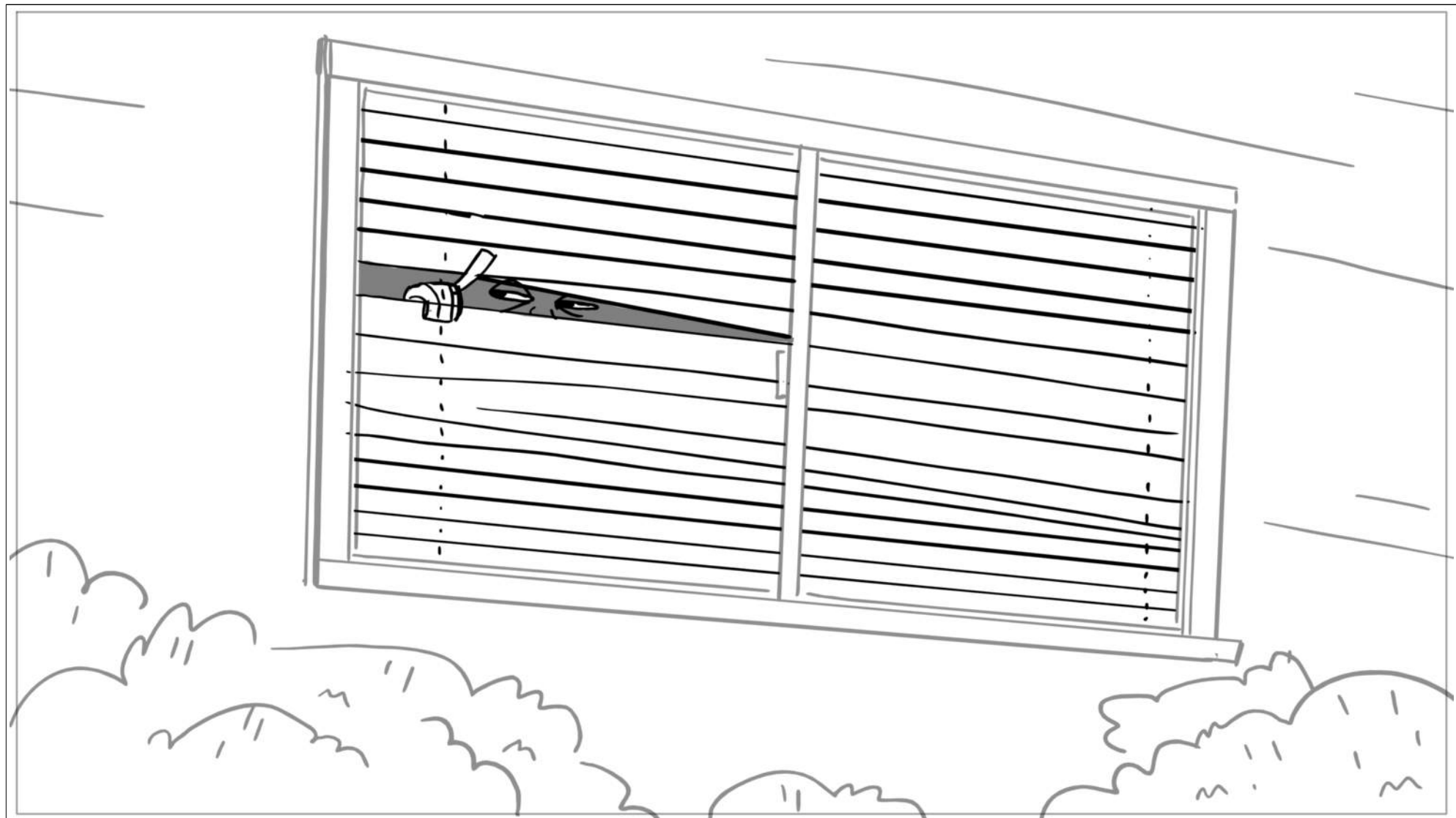

Scene	Duration	Panel	Duration
1	05:28:03	15	01:00



Scene	Duration	Panel	Duration
1	05:28:03	16	01:00



Scene	Duration	Panel	Duration
1	05:28:03	17	01:00

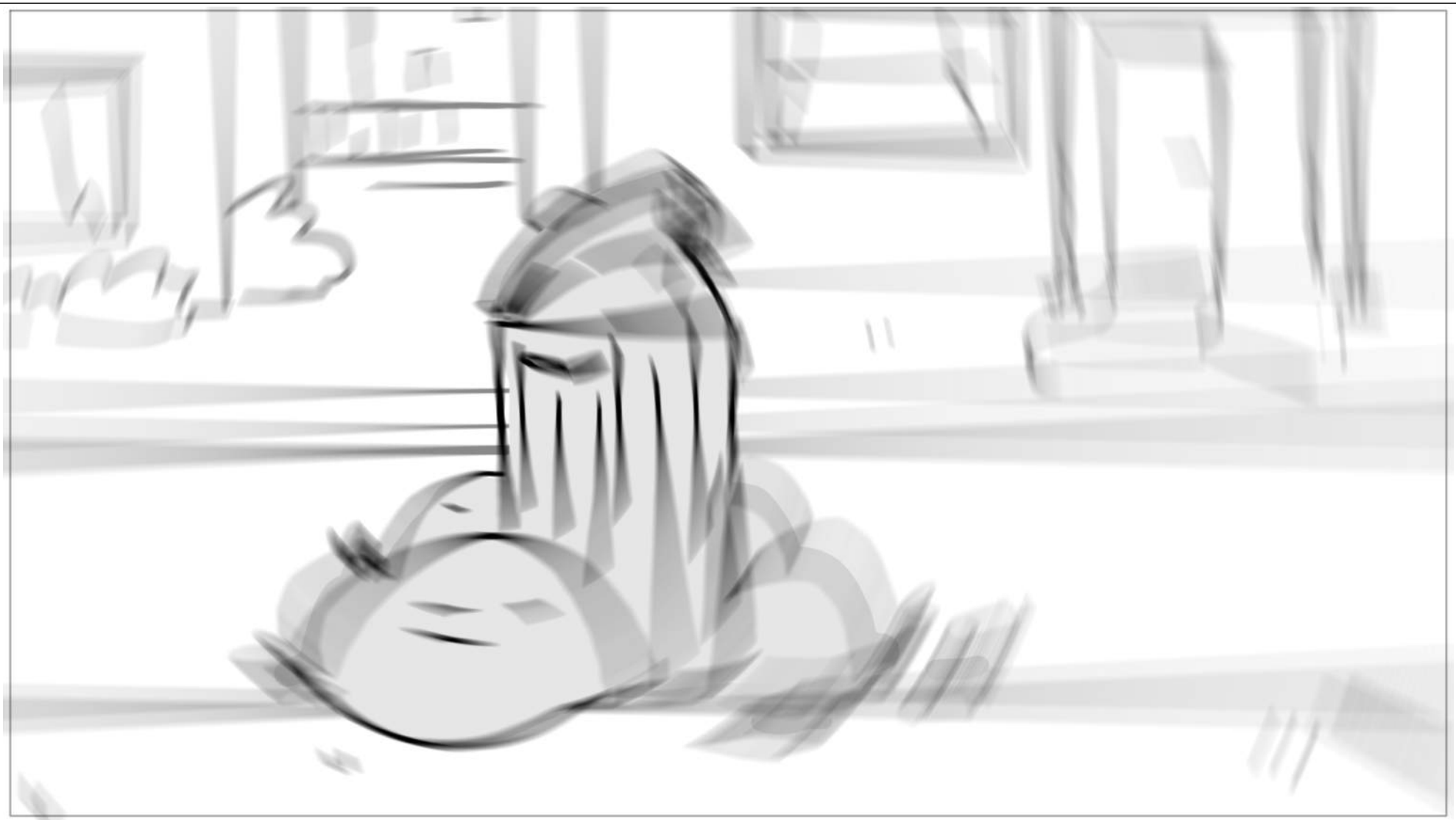

Scene	Duration	Panel	Duration
1	05:28:03	18	01:00



Scene	Duration	Panel	Duration
1	05:28:03	19	01:00

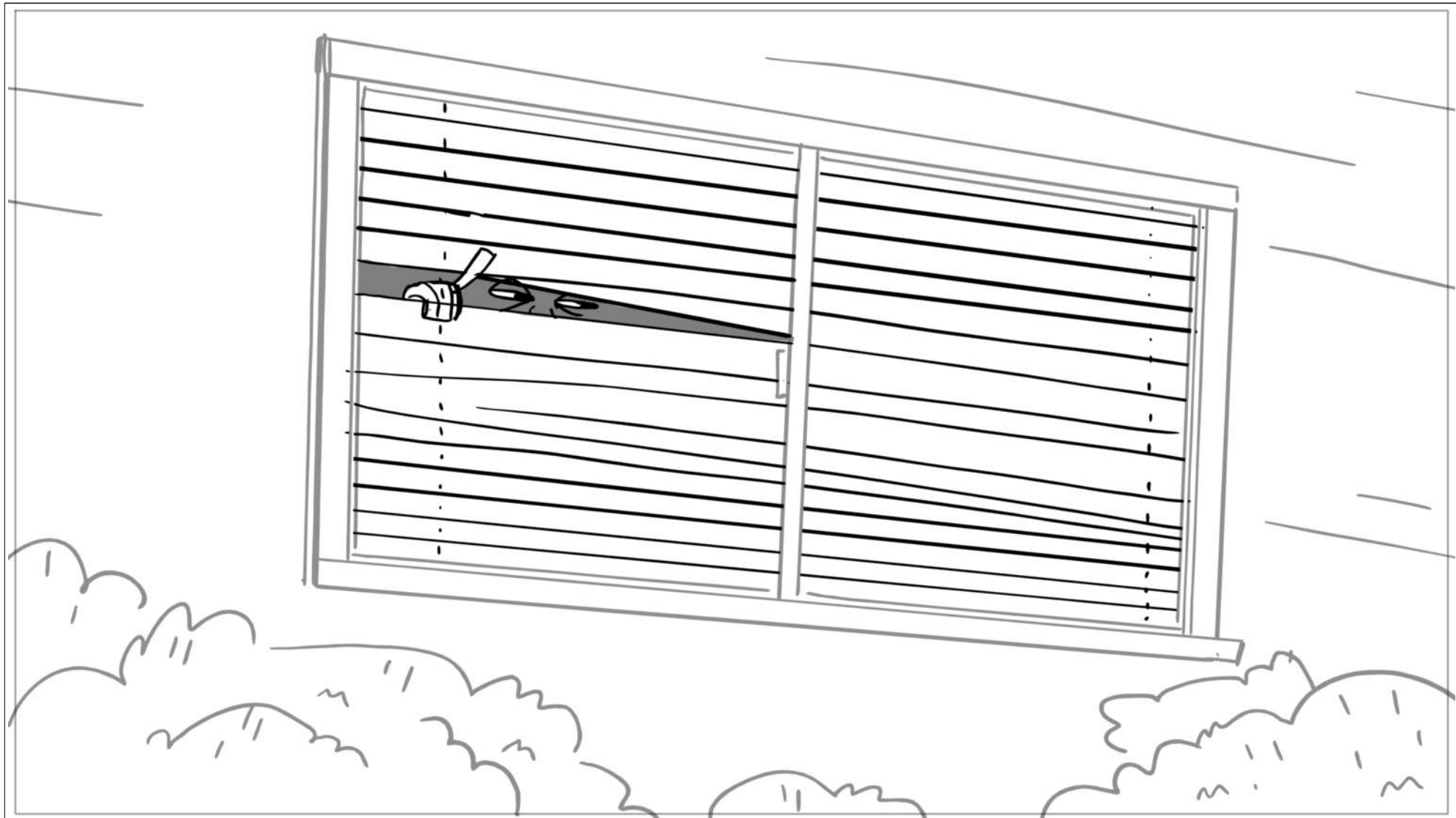

Scene	Duration	Panel	Duration
1	05:28:03	20	01:00

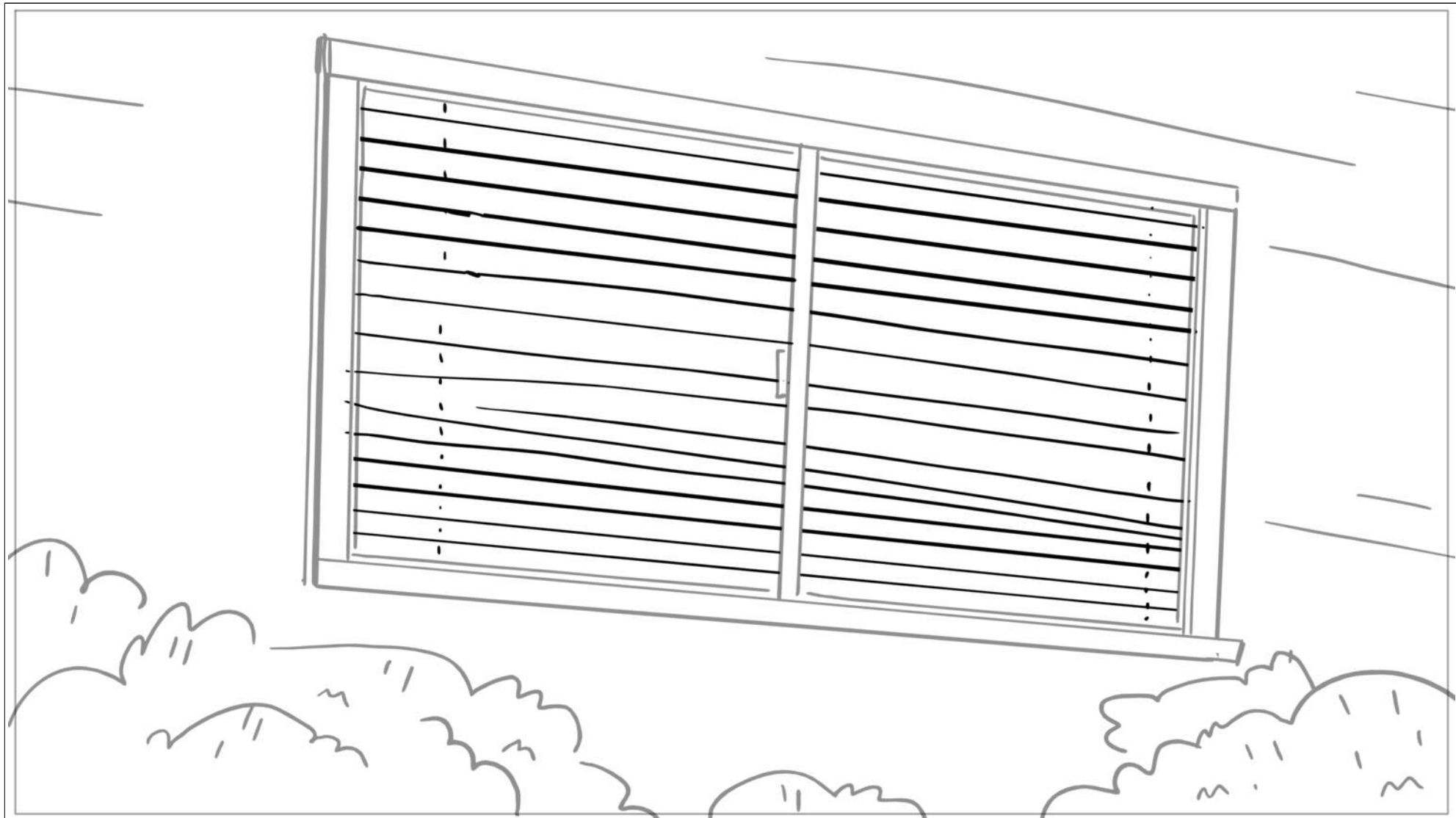

Scene	Duration	Panel	Duration
1	05:28:03	21	01:00

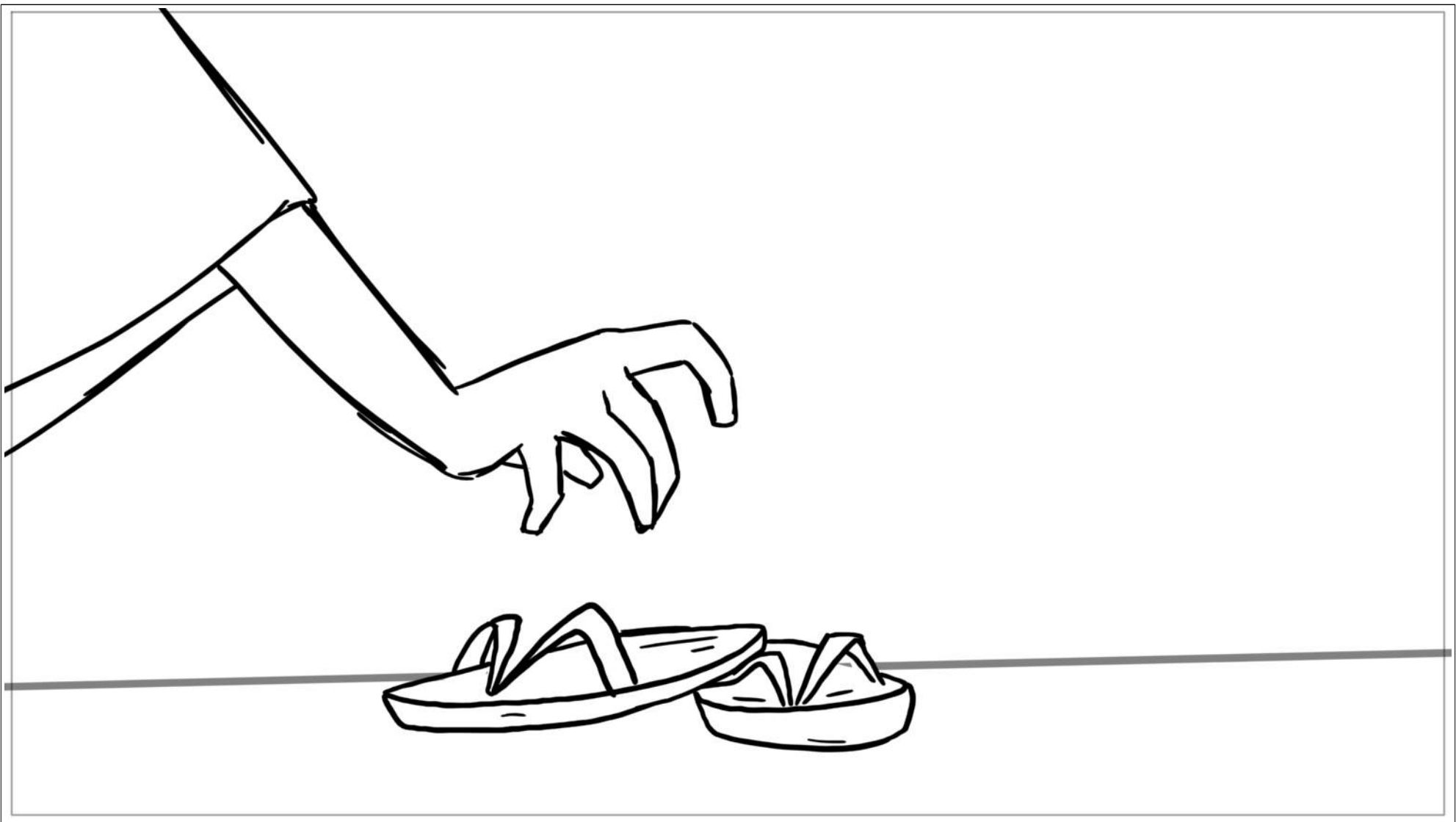

Scene	Duration	Panel	Duration
1	05:28:03	22	01:00



Scene	Duration	Panel	Duration
1	05:28:03	23	01:00



Scene	Duration	Panel	Duration
1	05:28:03	24	01:00

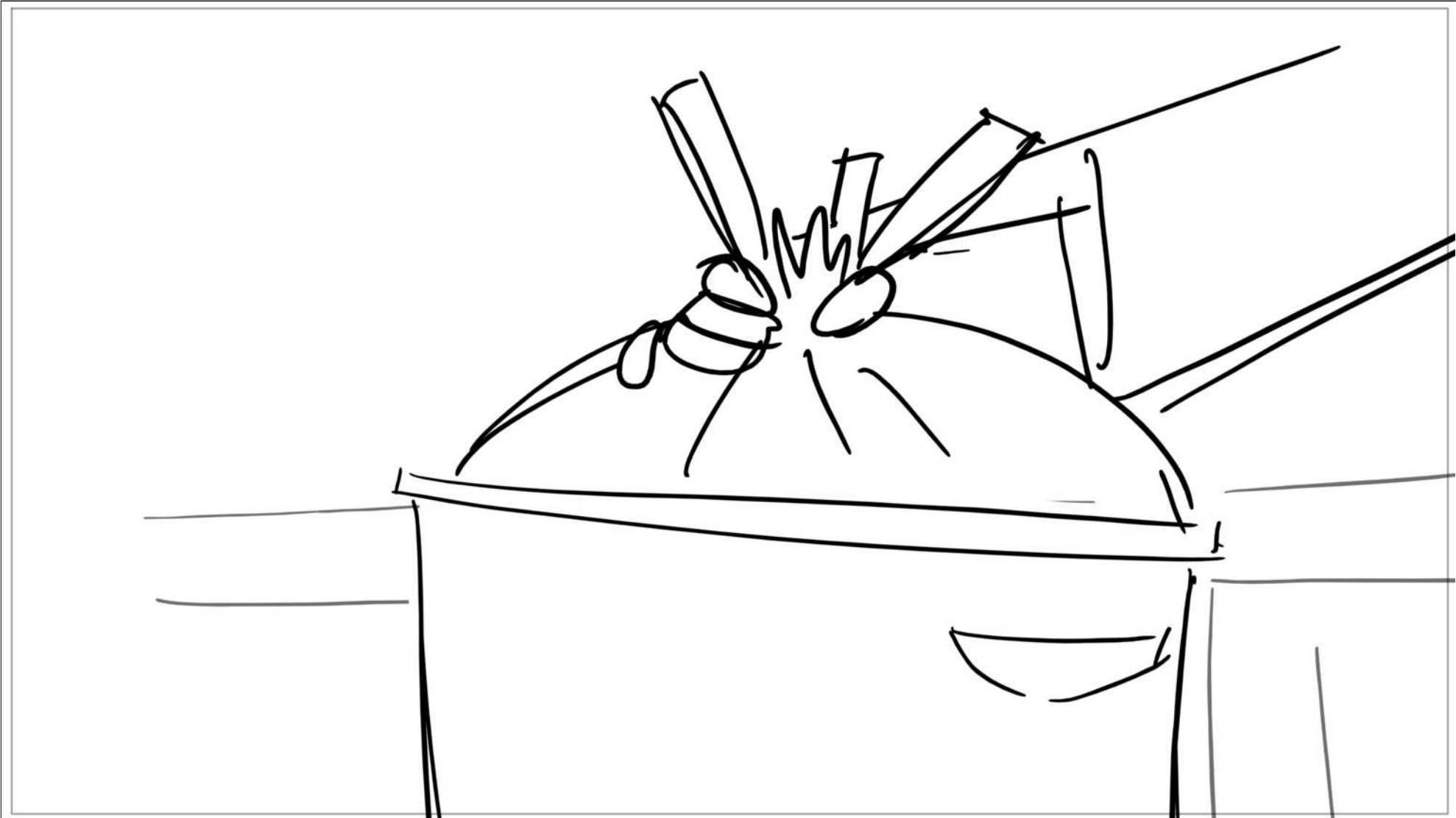

Scene	Duration	Panel	Duration
1	05:28:03	25	01:00



Scene	Duration	Panel	Duration
1	05:28:03	26	01:00

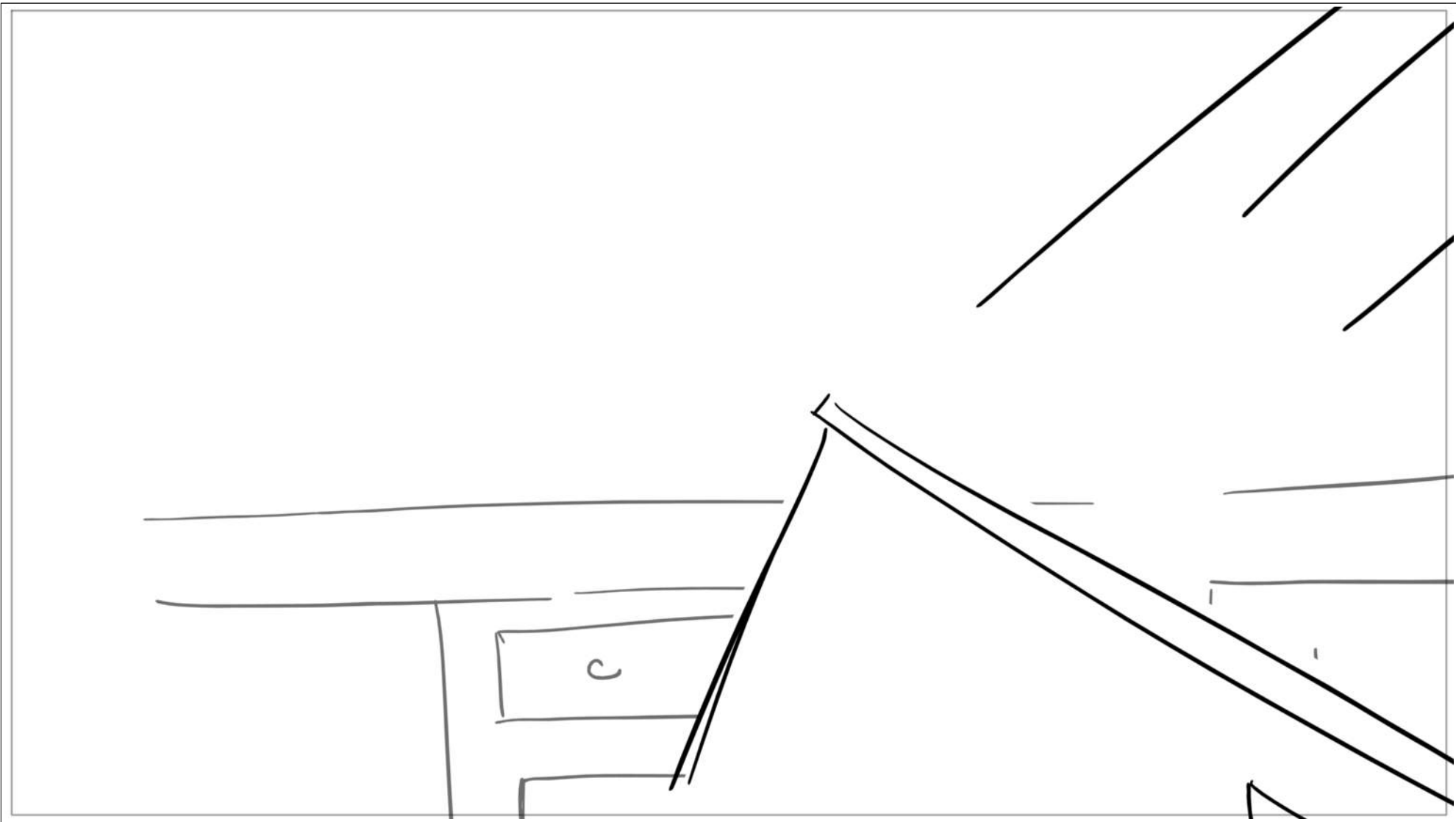

Scene	Duration	Panel	Duration
1	05:28:03	27	01:00

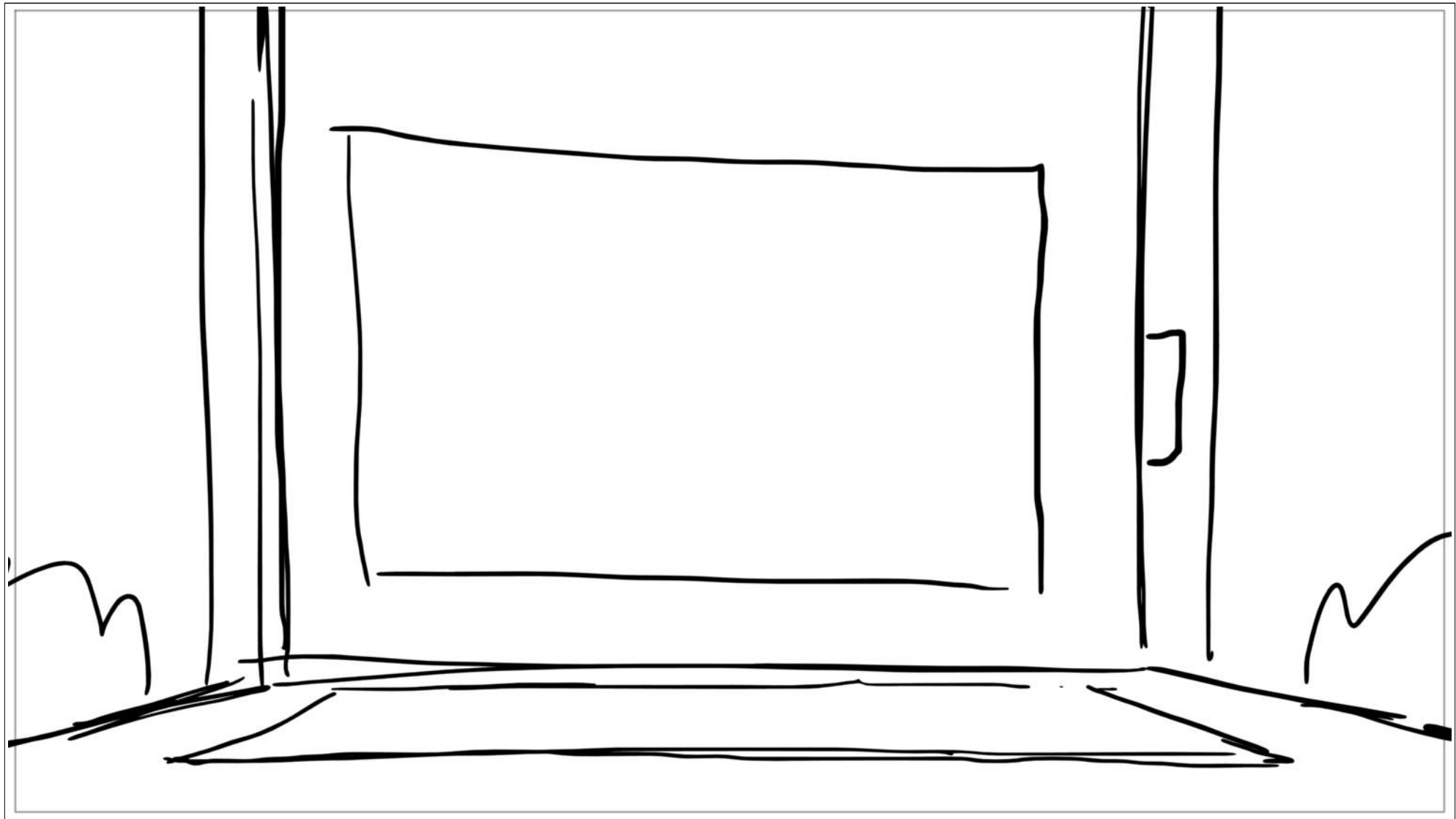

Scene	1	Duration	05:28:03	Panel	28	Duration	01:00
-------	---	----------	----------	-------	----	----------	-------

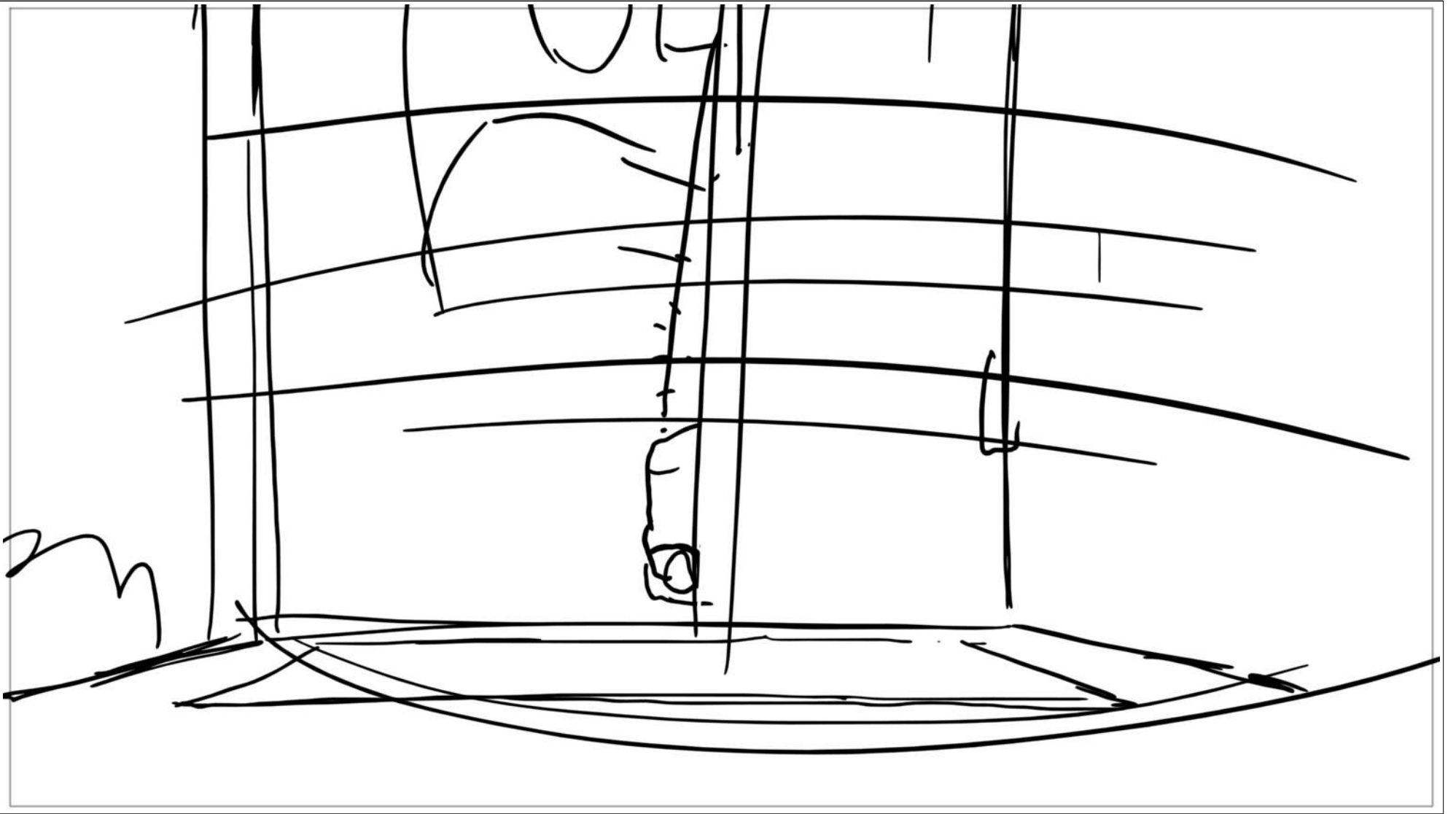

Scene	Duration	Panel	Duration
1	05:28:03	29	01:00



Scene	Duration	Panel	Duration
1	05:28:03	30	01:00



Scene	Duration	Panel	Duration
1	05:28:03	31	01:00



Scene	Duration	Panel	Duration
1	05:28:03	32	01:00



Scene	Duration	Panel	Duration
1	05:28:03	33	01:00



Scene	Duration	Panel	Duration
1	05:28:03	34	01:00



Scene	Duration	Panel	Duration
1	05:28:03	35	01:00



Scene	Duration	Panel	Duration
1	05:28:03	36	01:00

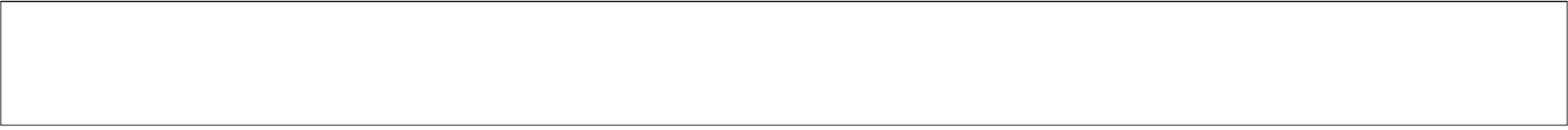

Scene	Duration	Panel	Duration
1	05:28:03	37	01:00

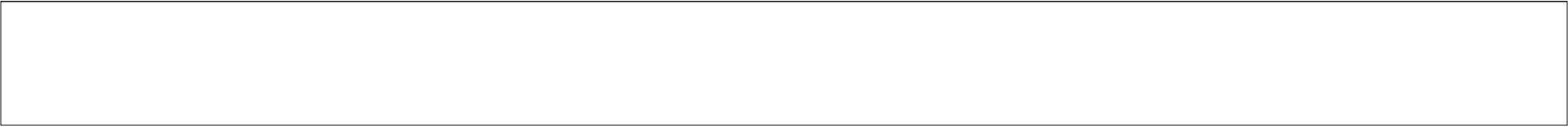

Scene	Duration	Panel	Duration
1	05:28:03	38	01:00

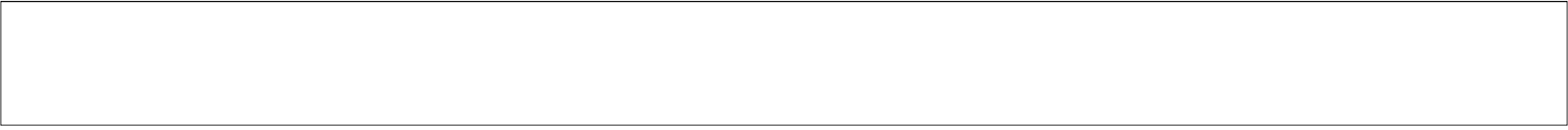

Scene	Duration	Panel	Duration
1	05:28:03	39	01:00



Scene	Duration	Panel	Duration
1	05:28:03	40	01:00



Scene	Duration	Panel	Duration
1	05:28:03	41	01:00

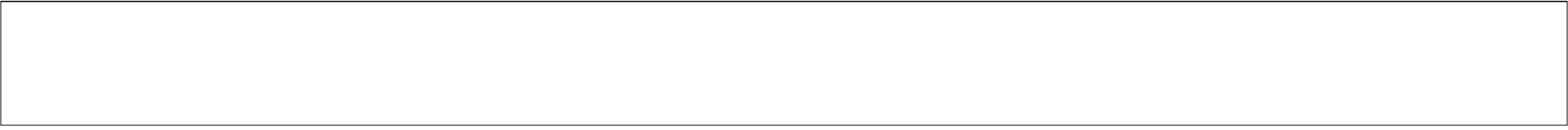

Scene	1	Duration	05:28:03	Panel	42	Duration	01:00
-------	---	----------	----------	-------	----	----------	-------



Scene	Duration	Panel	Duration
1	05:28:03	43	01:00



Scene	1	Duration	05:28:03	Panel	44	Duration	01:00
-------	---	----------	----------	-------	----	----------	-------



Scene	Duration	Panel	Duration
1	05:28:03	45	01:00



Scene	Duration	Panel	Duration
1	05:28:03	46	01:00



Scene	Duration	Panel	Duration
1	05:28:03	47	01:00



Scene	Duration	Panel	Duration
1	05:28:03	48	01:00



Scene	Duration	Panel	Duration
1	05:28:03	49	01:00



Scene	Duration	Panel	Duration
1	05:28:03	50	01:00



Scene	Duration	Panel	Duration
1	05:28:03	51	01:00



Scene	Duration	Panel	Duration
1	05:28:03	52	01:00



Scene	Duration	Panel	Duration
1	05:28:03	53	01:00

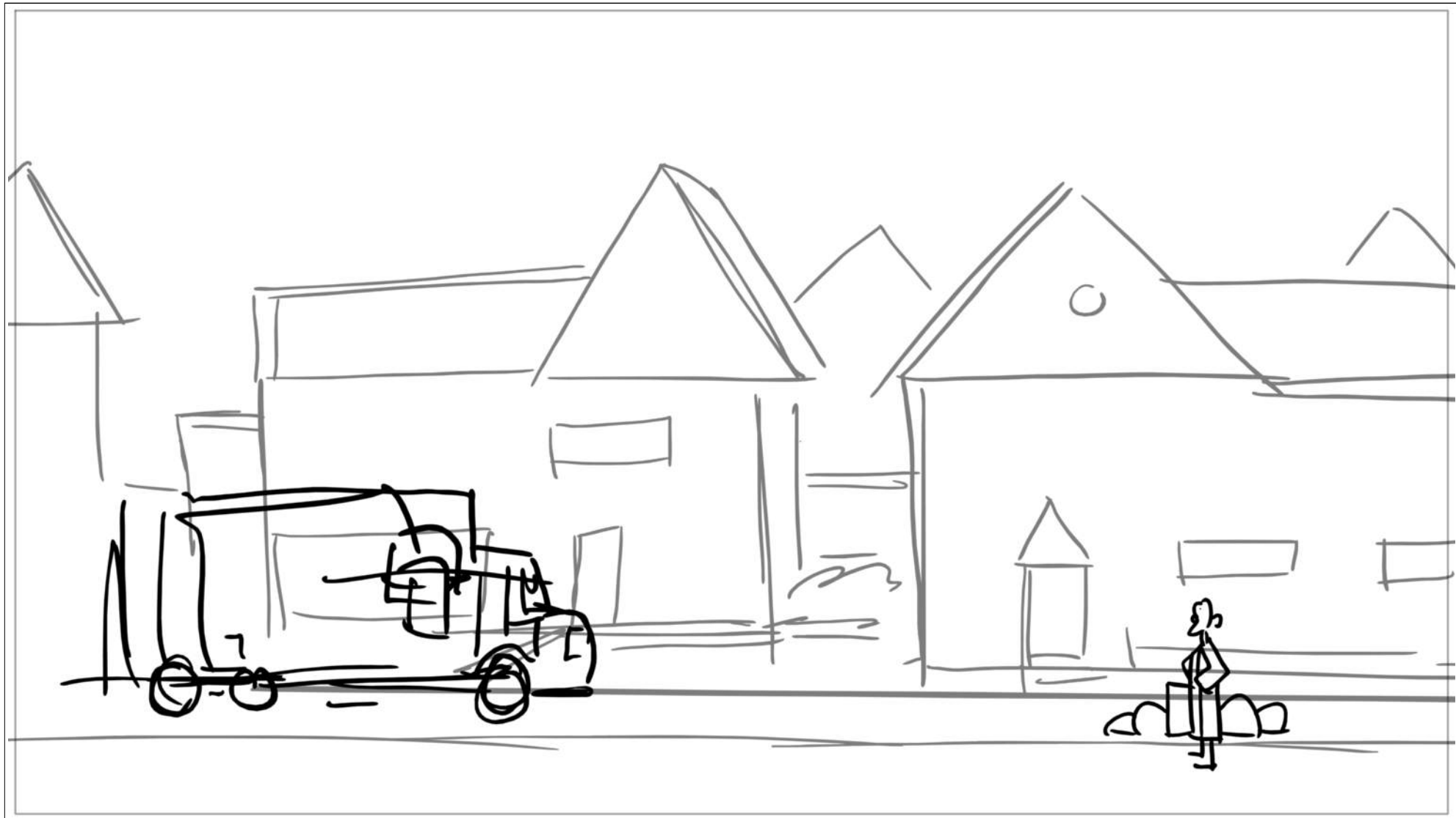

Scene	Duration	Panel	Duration
1	05:28:03	54	01:00

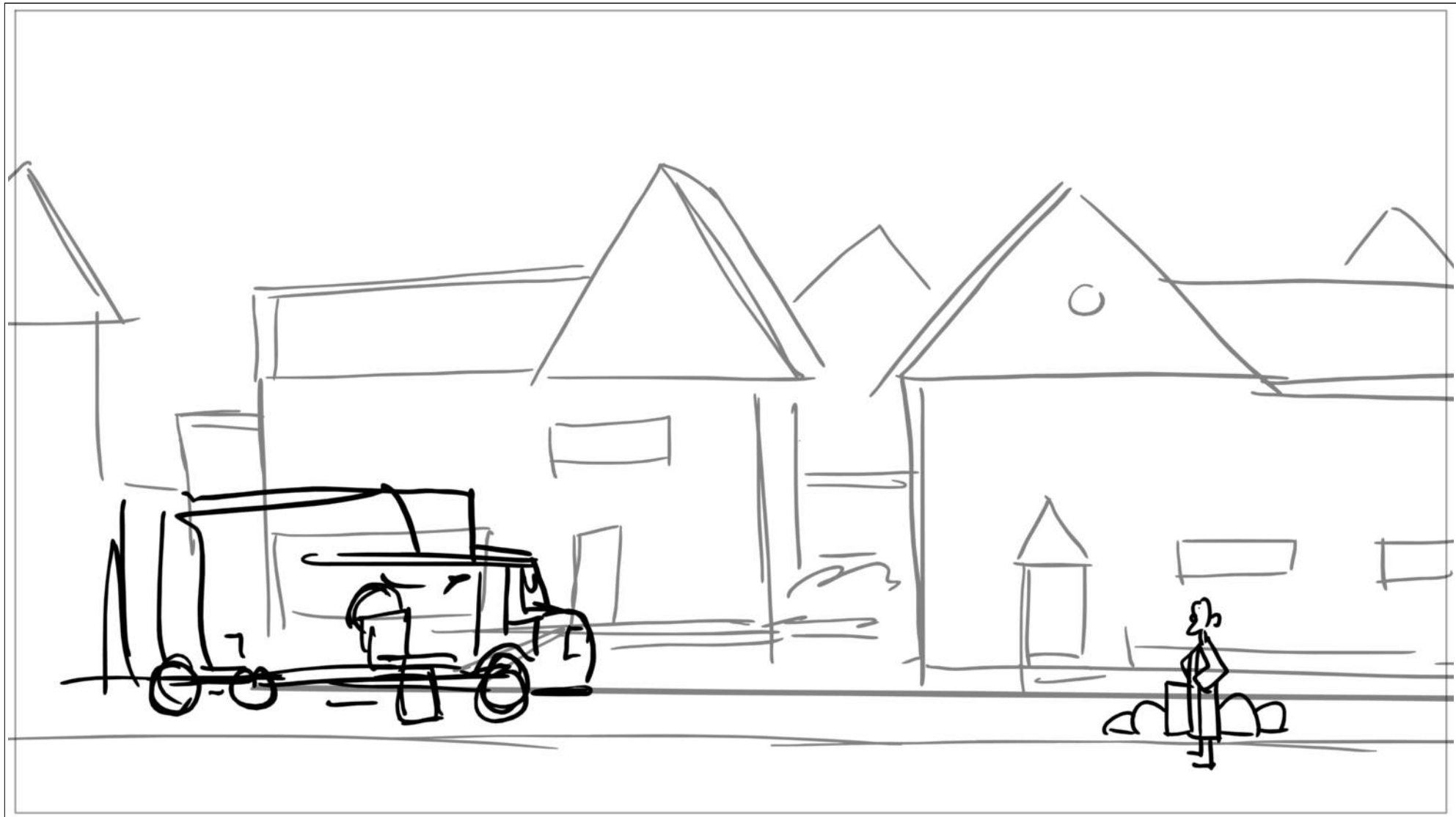

Scene	Duration	Panel	Duration
1	05:28:03	55	01:00

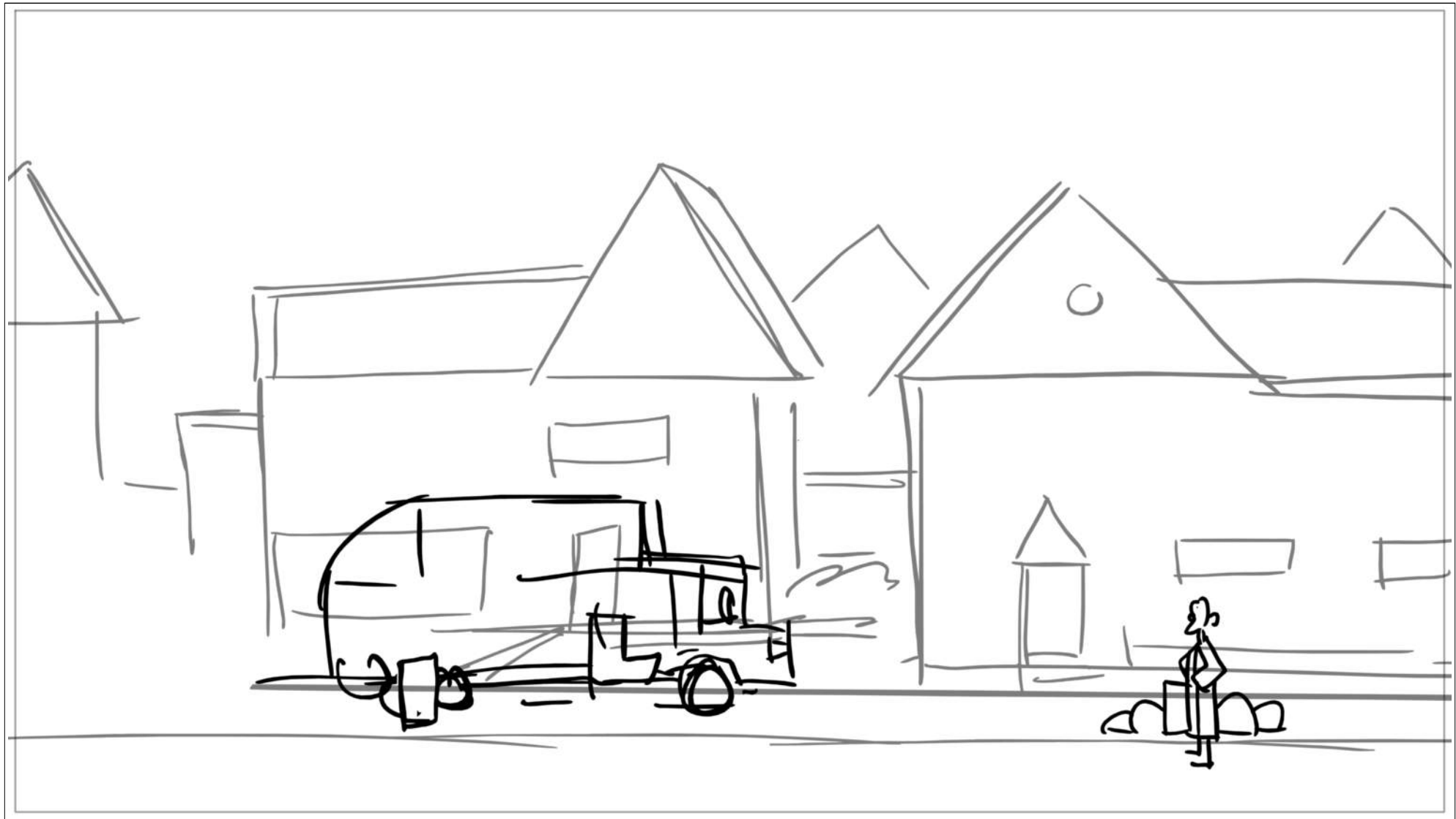

Scene	Duration	Panel	Duration
1	05:28:03	56	01:00

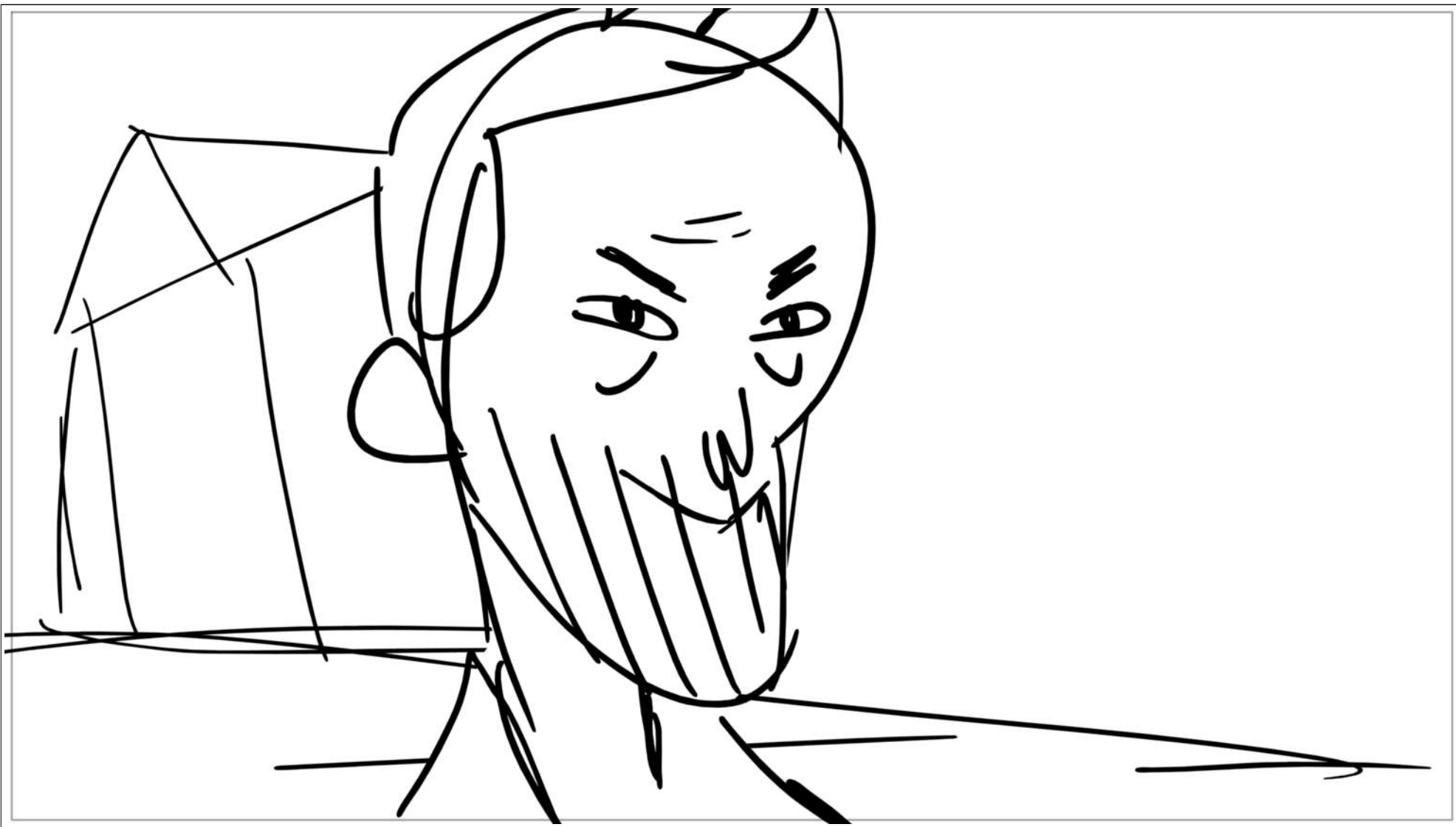

Scene	Duration	Panel	Duration
1	05:28:03	57	01:00



Scene	Duration	Panel	Duration
1	05:28:03	58	01:00

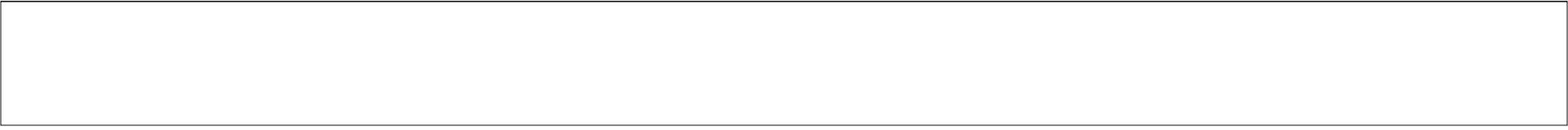
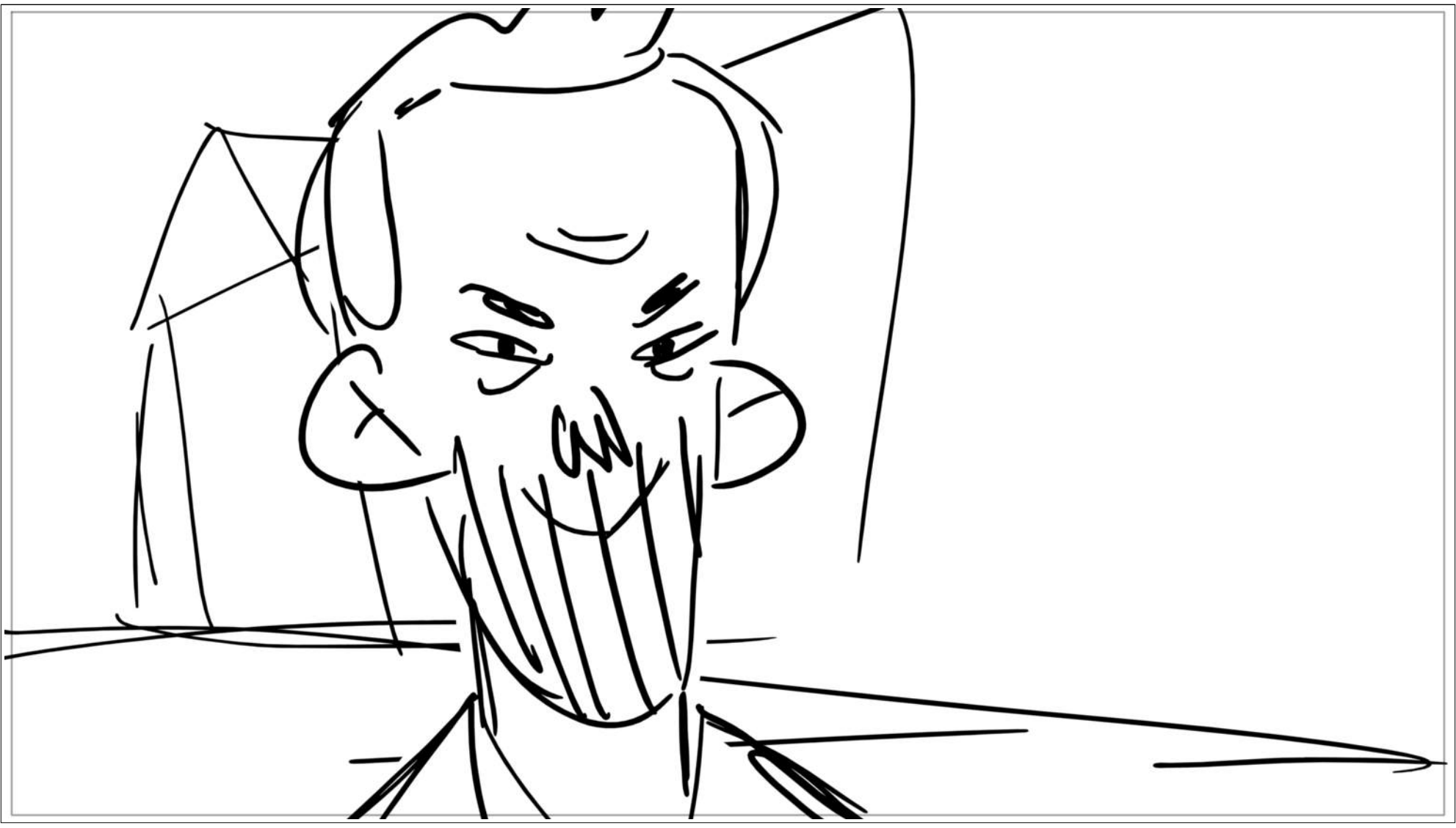

Scene	Duration	Panel	Duration
1	05:28:03	59	01:00

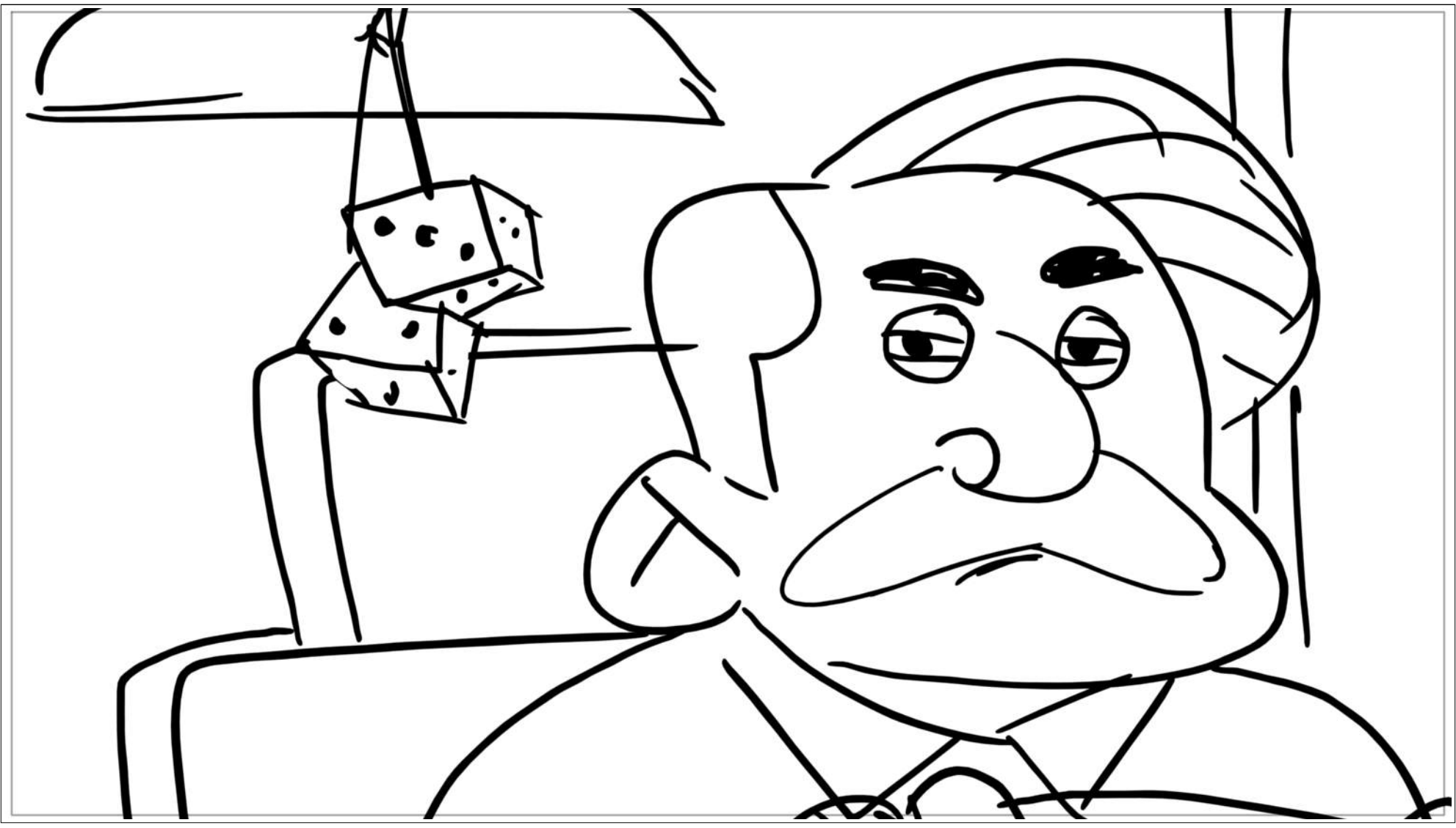

Scene	Duration	Panel	Duration
1	05:28:03	60	01:00



Scene	Duration	Panel	Duration
1	05:28:03	61	01:00



Scene	Duration	Panel	Duration
1	05:28:03	62	01:00



Scene	Duration	Panel	Duration
1	05:28:03	63	01:00



Scene	Duration	Panel	Duration
1	05:28:03	64	01:00



Scene	Duration	Panel	Duration
1	05:28:03	65	01:00



Scene	Duration	Panel	Duration
1	05:28:03	66	01:00



Scene	Duration	Panel	Duration
1	05:28:03	67	01:00



Scene	Duration	Panel	Duration
1	05:28:03	68	01:00



Scene	Duration	Panel	Duration
1	05:28:03	69	01:00



Scene	Duration	Panel	Duration
1	05:28:03	70	01:00

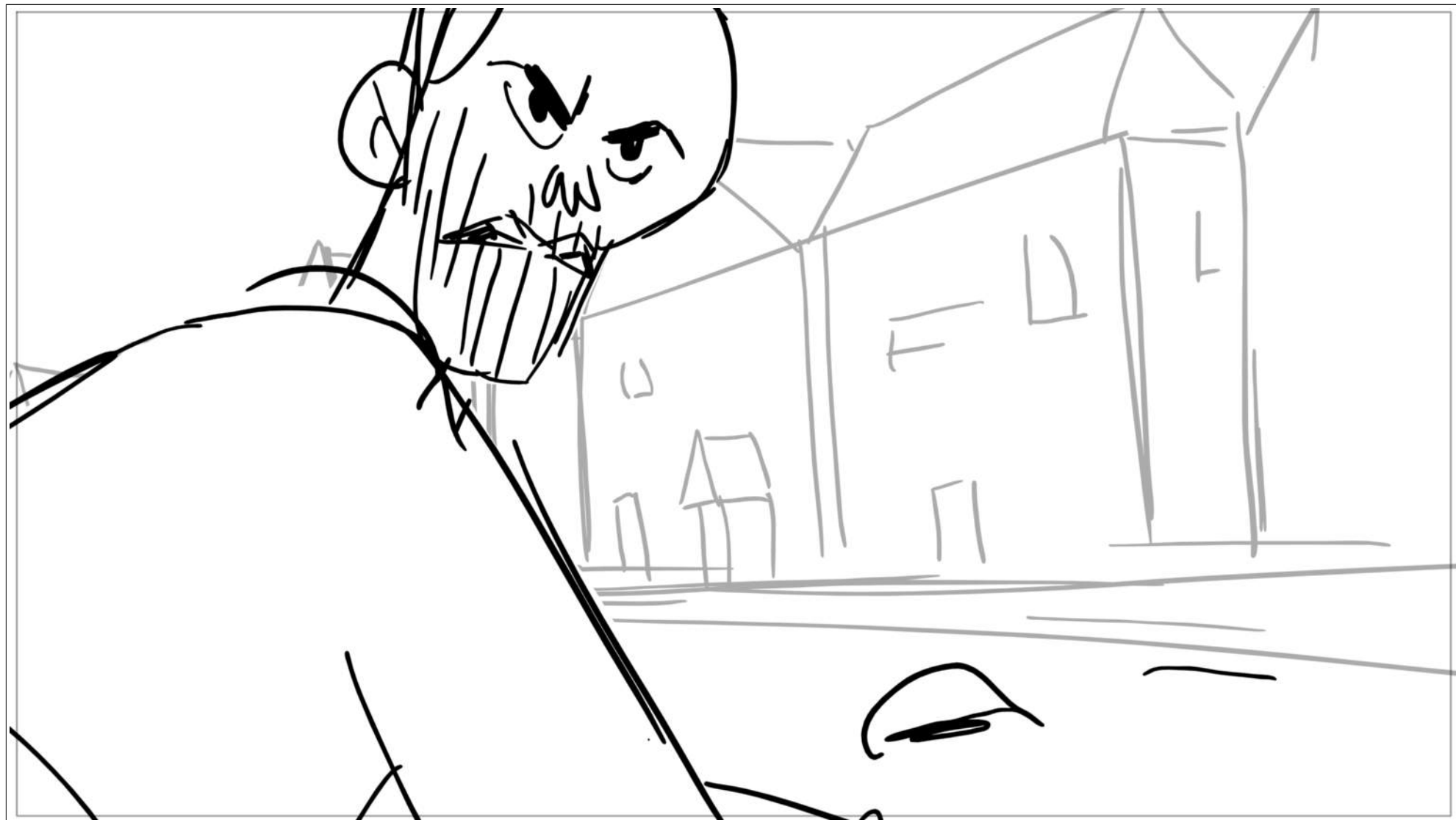

Scene	Duration	Panel	Duration
1	05:28:03	71	01:00



Scene	Duration	Panel	Duration
1	05:28:03	72	01:00



Scene	1	Duration	05:28:03	Panel	73	Duration	01:00
-------	---	----------	----------	-------	----	----------	-------



Scene	Duration	Panel	Duration
1	05:28:03	74	01:00



Scene	1	Duration	05:28:03	Panel	75	Duration	01:00
-------	---	----------	----------	-------	----	----------	-------



Scene	Duration	Panel	Duration
1	05:28:03	76	01:00



Scene	Duration	Panel	Duration
1	05:28:03	77	01:00

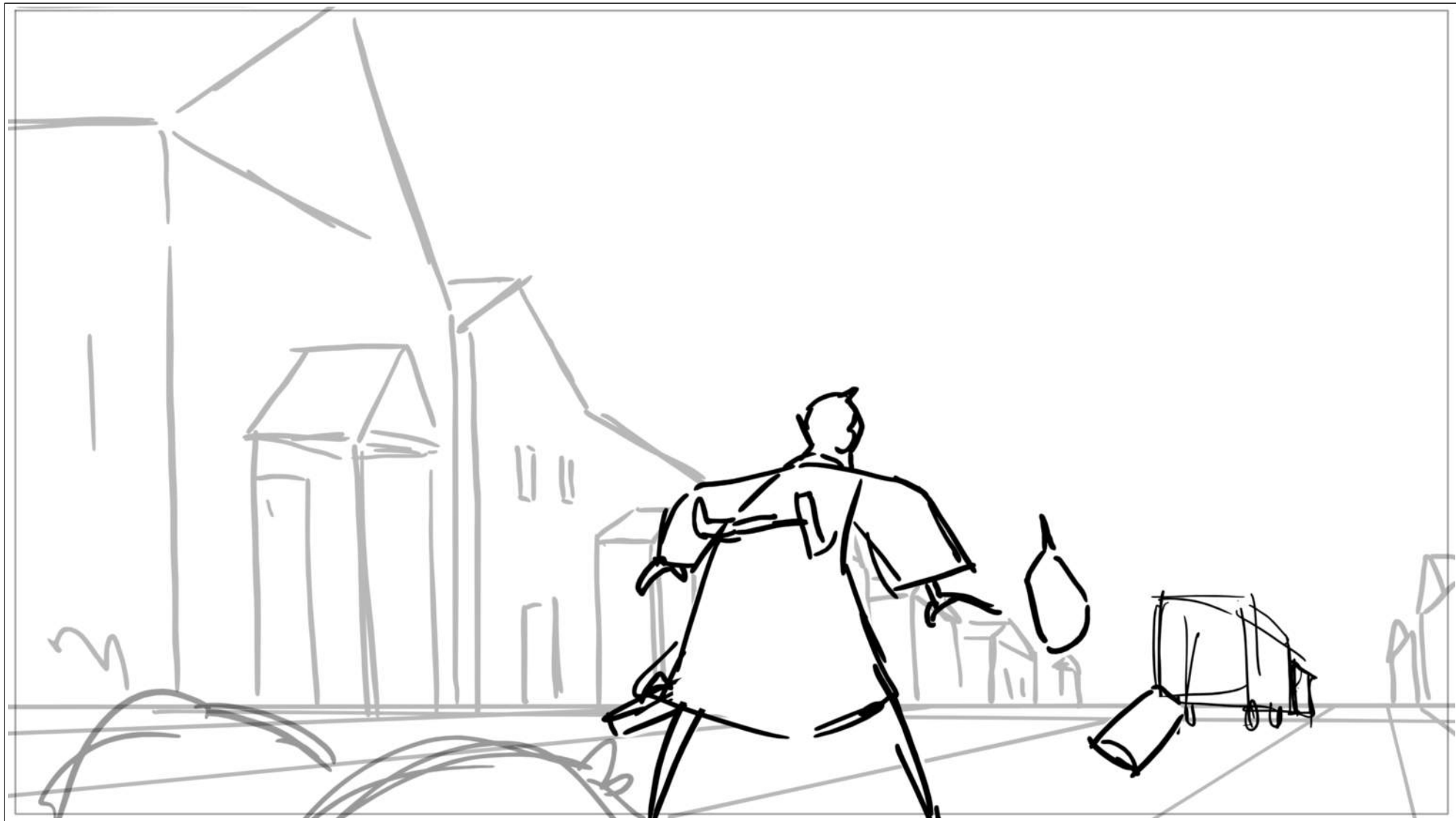

Scene	Duration	Panel	Duration
1	05:28:03	78	01:00

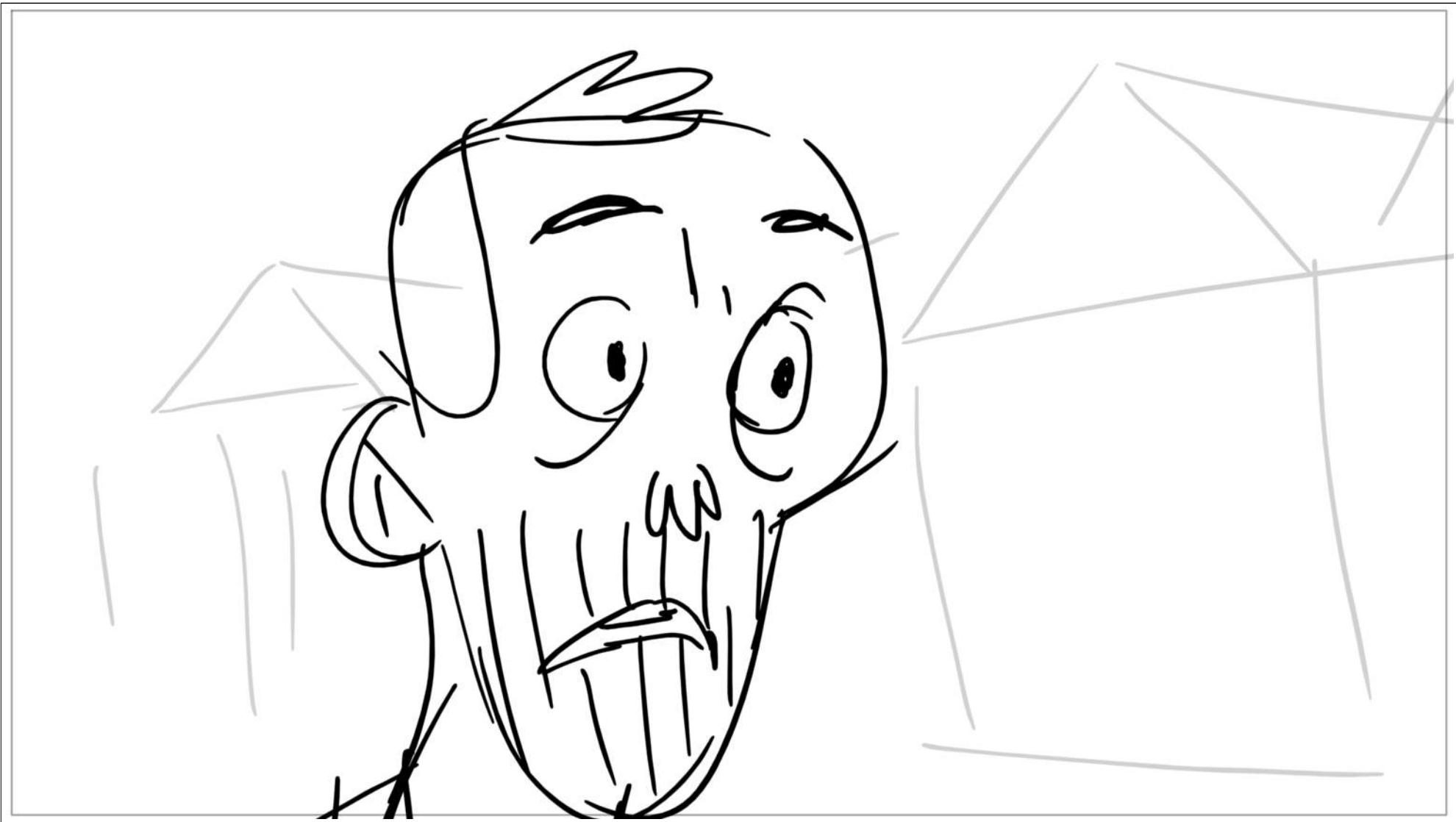

Scene	Duration	Panel	Duration
1	05:28:03	79	01:00



Scene	Duration	Panel	Duration
1	05:28:03	80	01:00



Scene	Duration	Panel	Duration
1	05:28:03	81	01:00



Scene	Duration	Panel	Duration
1	05:28:03	82	01:00



Scene	Duration	Panel	Duration
1	05:28:03	83	01:00



Scene	Duration	Panel	Duration
1	05:28:03	84	01:00



Scene	Duration	Panel	Duration
1	05:28:03	85	01:00



Scene	Duration	Panel	Duration
1	05:28:03	86	01:00

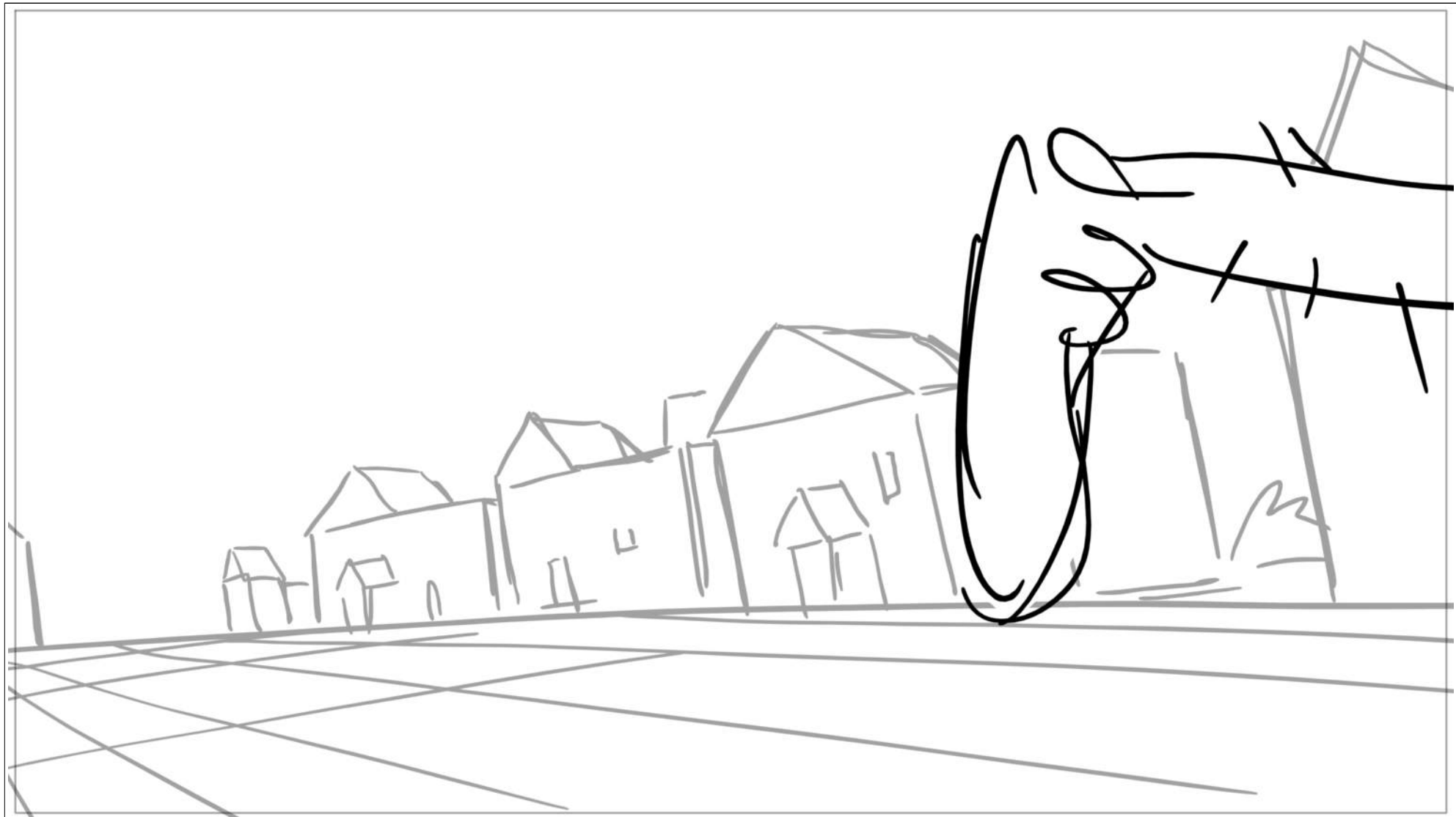

Scene	Duration	Panel	Duration
1	05:28:03	87	01:00



Scene	Duration	Panel	Duration
1	05:28:03	88	01:00



Scene	Duration	Panel	Duration
1	05:28:03	89	01:00



Scene	Duration	Panel	Duration
1	05:28:03	90	01:00

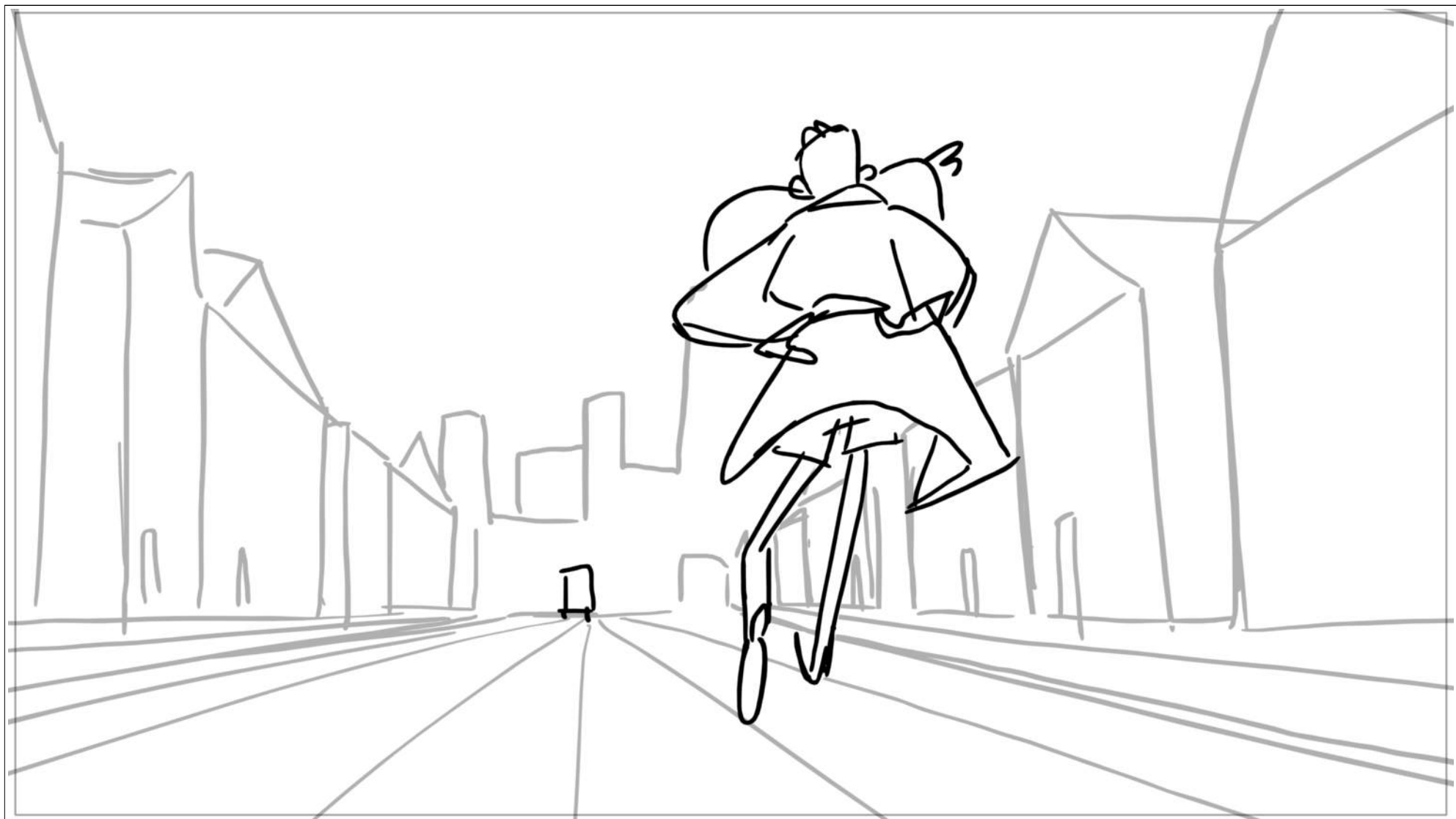

Scene	Duration	Panel	Duration
1	05:28:03	91	01:00

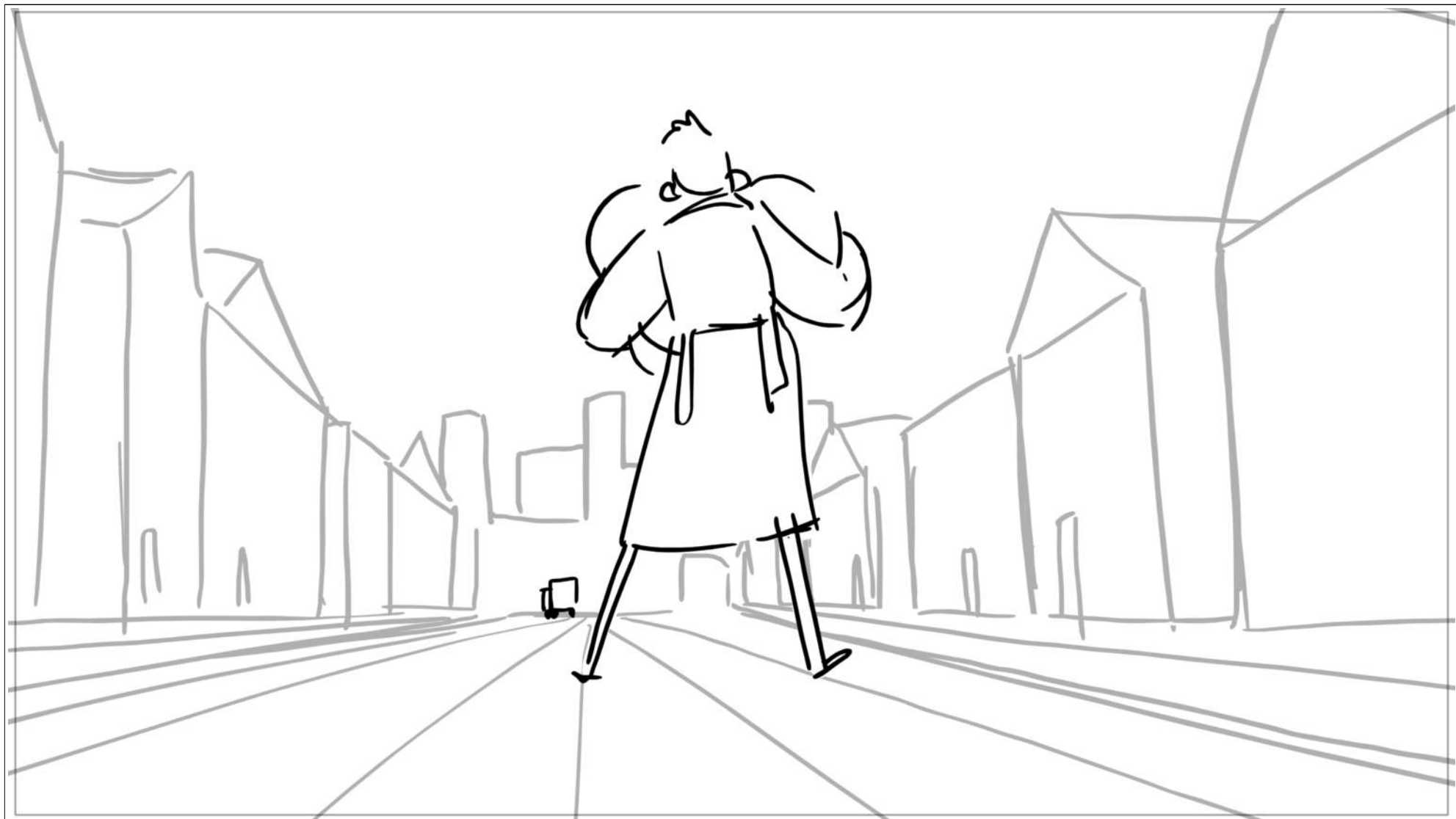

Scene	Duration	Panel	Duration
1	05:28:03	92	01:00

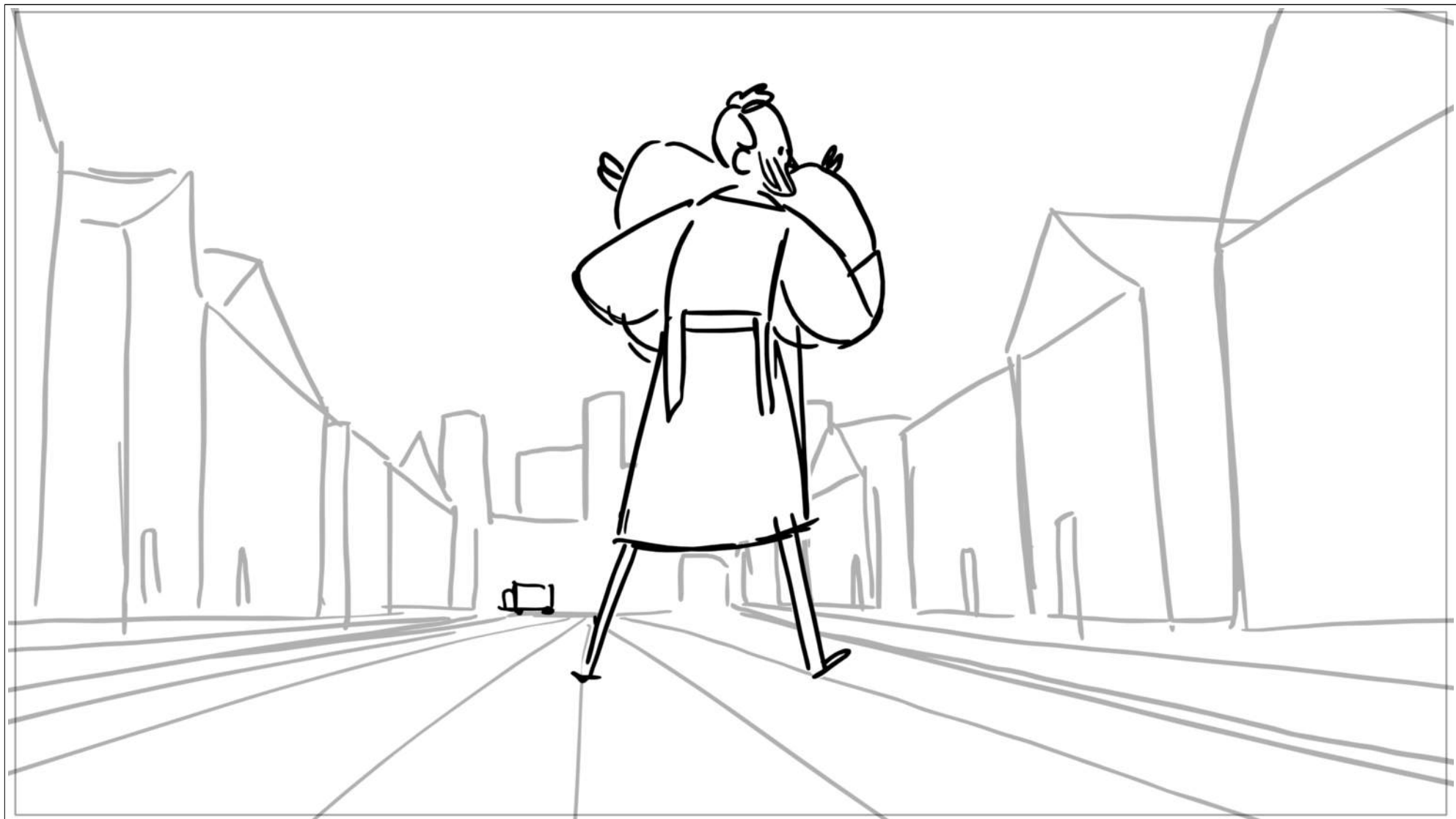

Scene	Duration	Panel	Duration
1	05:28:03	93	01:00



Scene	Duration	Panel	Duration
1	05:28:03	94	01:00



Scene	Duration	Panel	Duration
1	05:28:03	95	01:00

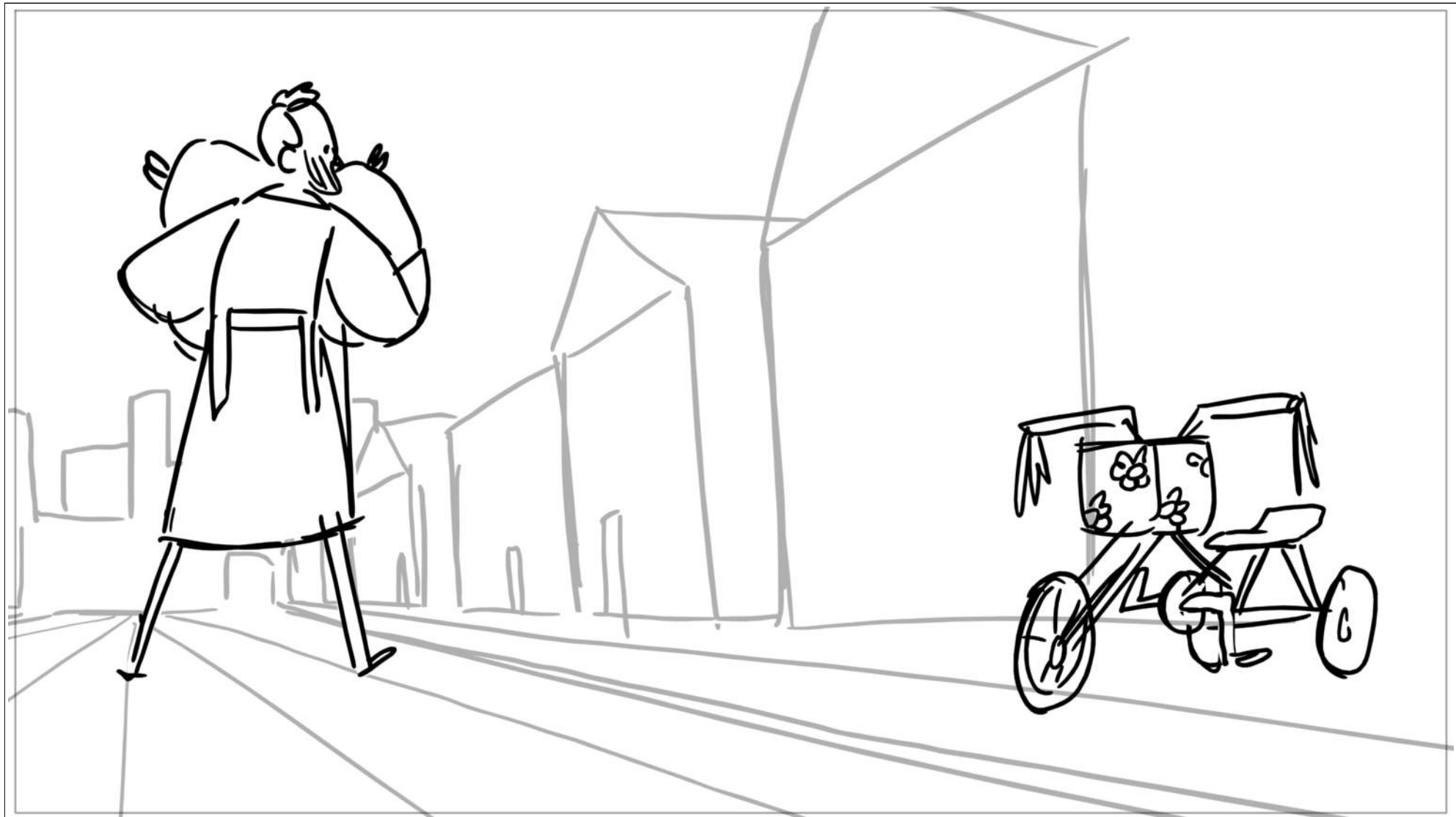

Scene	Duration	Panel	Duration
1	05:28:03	96	01:00

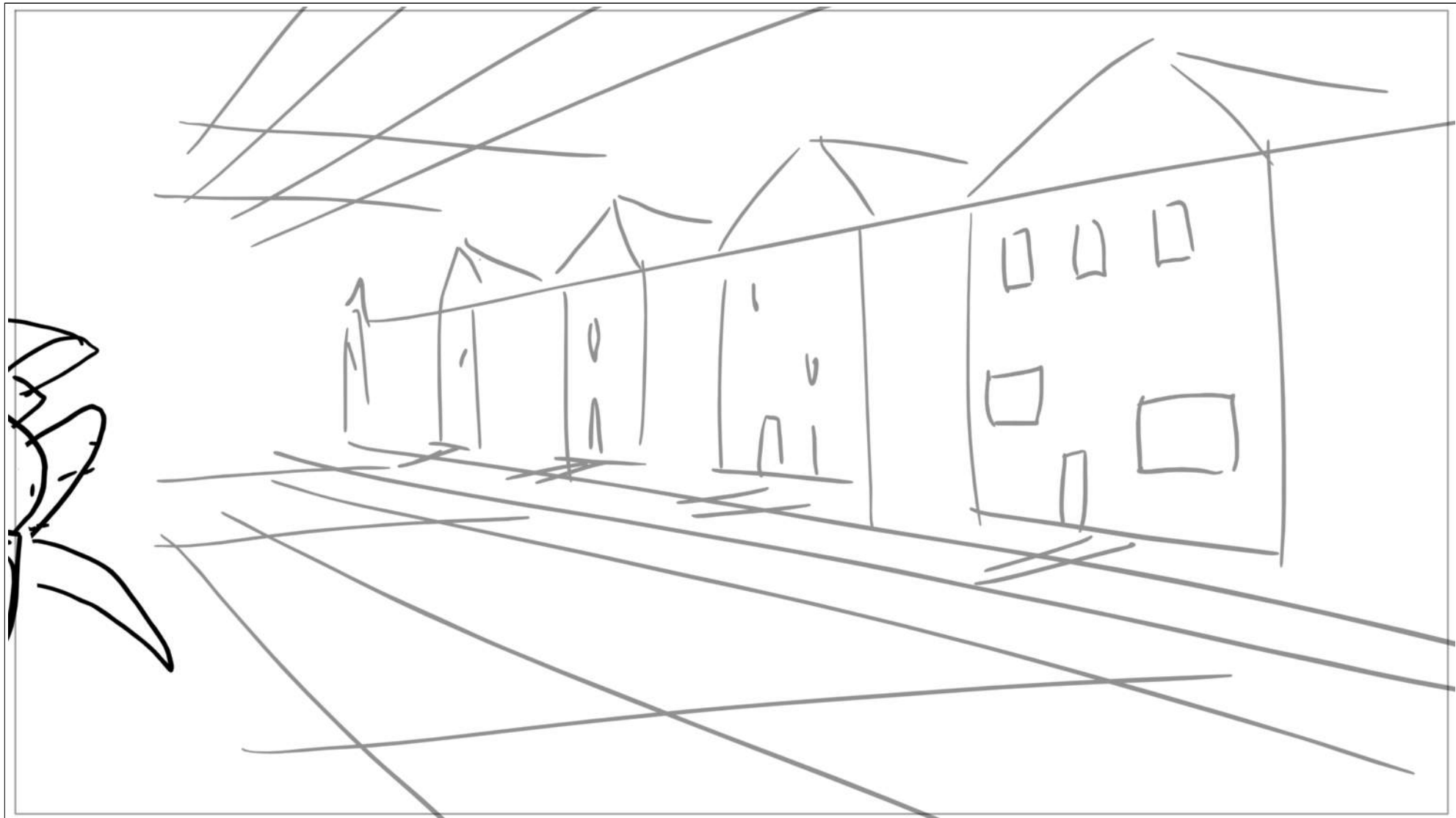

Scene	Duration	Panel	Duration
1	05:28:03	97	01:00



Scene	Duration	Panel	Duration
1	05:28:03	98	01:00



Scene	Duration	Panel	Duration
1	05:28:03	99	01:00

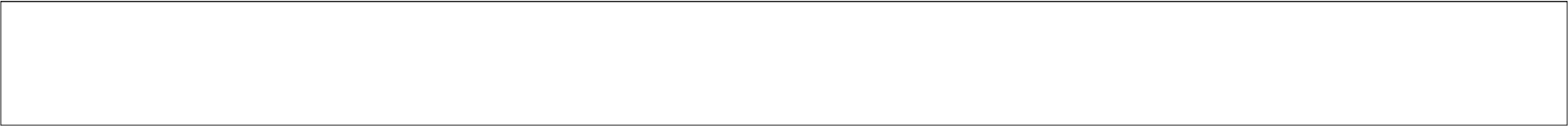

Scene	Duration	Panel	Duration
1	05:28:03	100	01:00

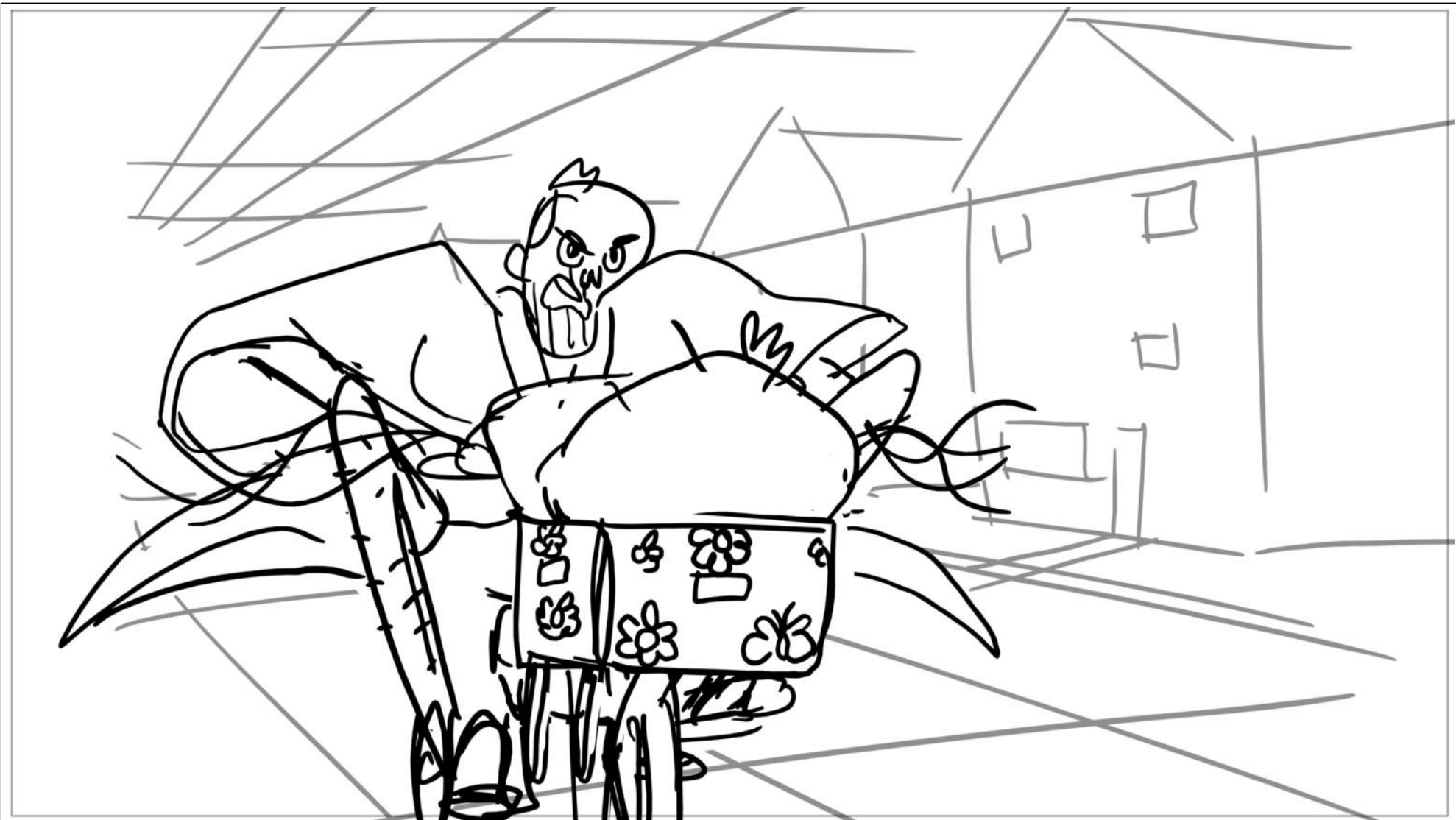

Scene	Duration	Panel	Duration
1	05:28:03	101	01:00

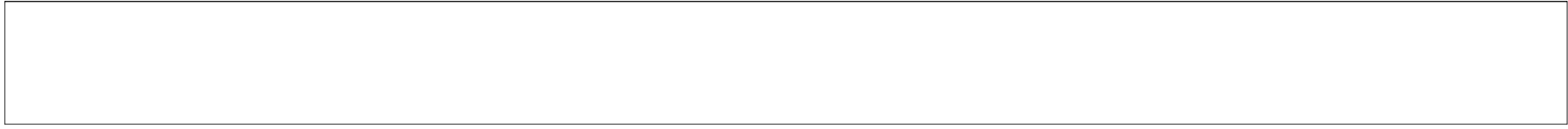

Scene	Duration	Panel	Duration
1	05:28:03	102	01:00



Scene	Duration	Panel	Duration
1	05:28:03	103	01:00

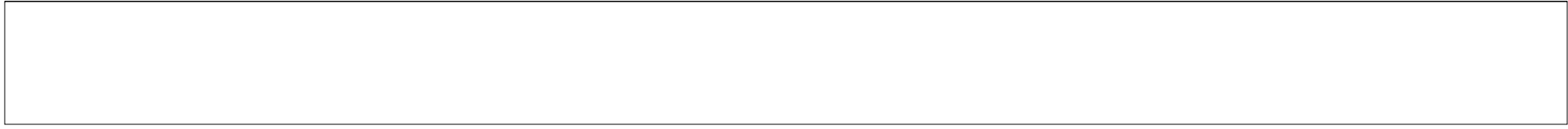

Scene	Duration	Panel	Duration
1	05:28:03	104	01:00



Scene	Duration	Panel	Duration
1	05:28:03	105	01:00



Scene	Duration	Panel	Duration
1	05:28:03	106	01:00



Scene	Duration	Panel	Duration
1	05:28:03	107	01:00



Scene	Duration	Panel	Duration
1	05:28:03	108	01:00



Scene	Duration	Panel	Duration
1	05:28:03	109	01:00



Scene	Duration	Panel	Duration
1	05:28:03	110	01:00



Scene	Duration	Panel	Duration
1	05:28:03	111	01:00

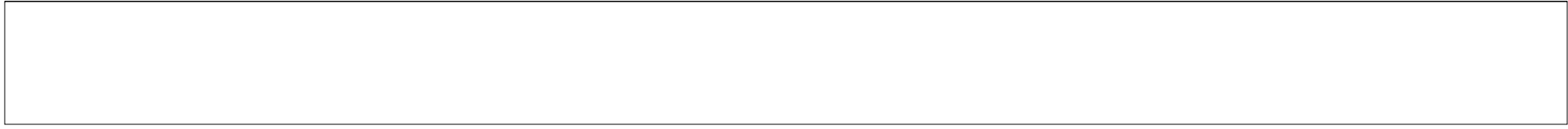

Scene	Duration	Panel	Duration
1	05:28:03	112	01:00



Scene	Duration	Panel	Duration
1	05:28:03	113	01:00



Scene	Duration	Panel	Duration
1	05:28:03	114	01:00



Scene	Duration	Panel	Duration
1	05:28:03	115	01:00



Scene	Duration	Panel	Duration
1	05:28:03	116	01:00



Scene	Duration	Panel	Duration
1	05:28:03	117	01:00



Scene	Duration	Panel	Duration
1	05:28:03	118	01:00

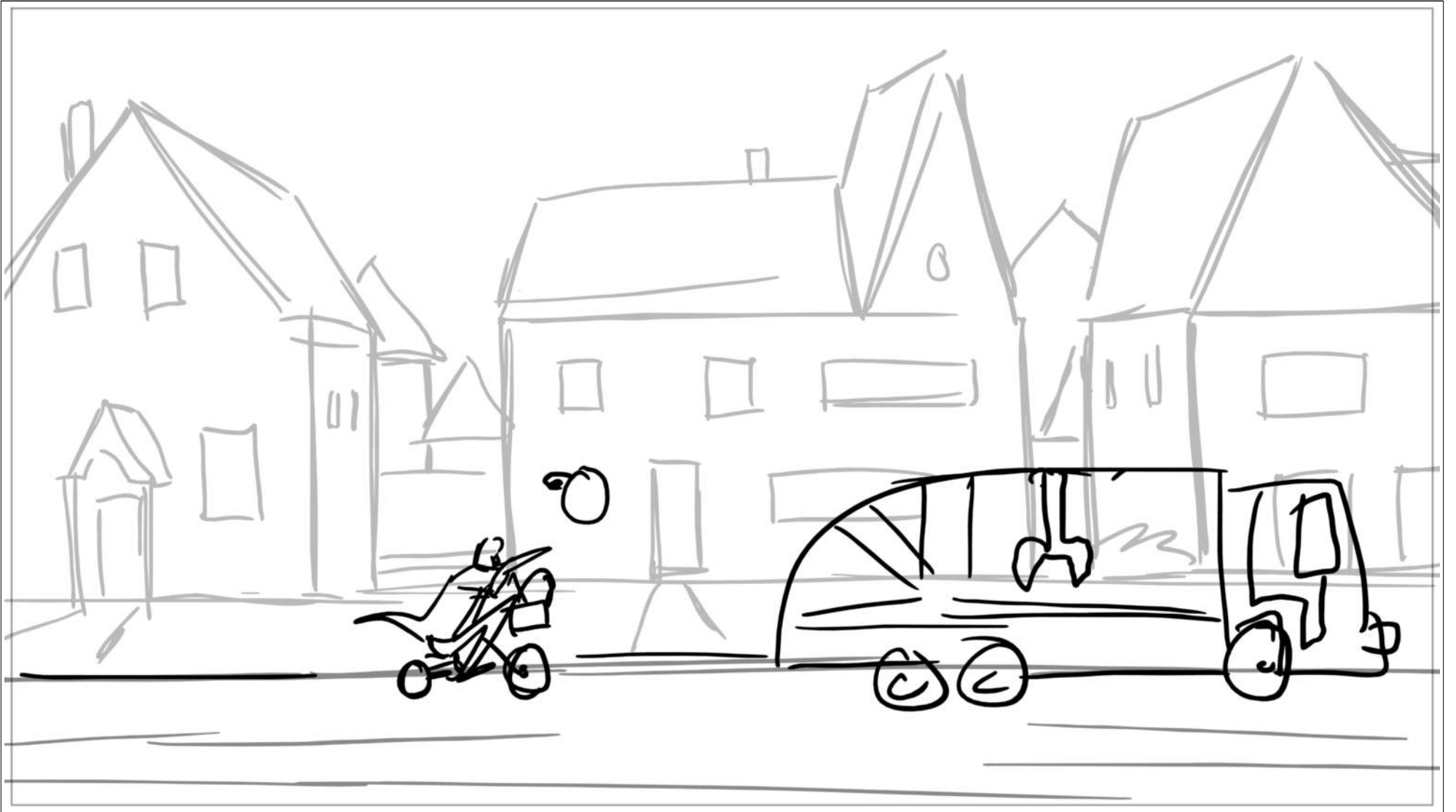

Scene	Duration	Panel	Duration
1	05:28:03	119	01:00

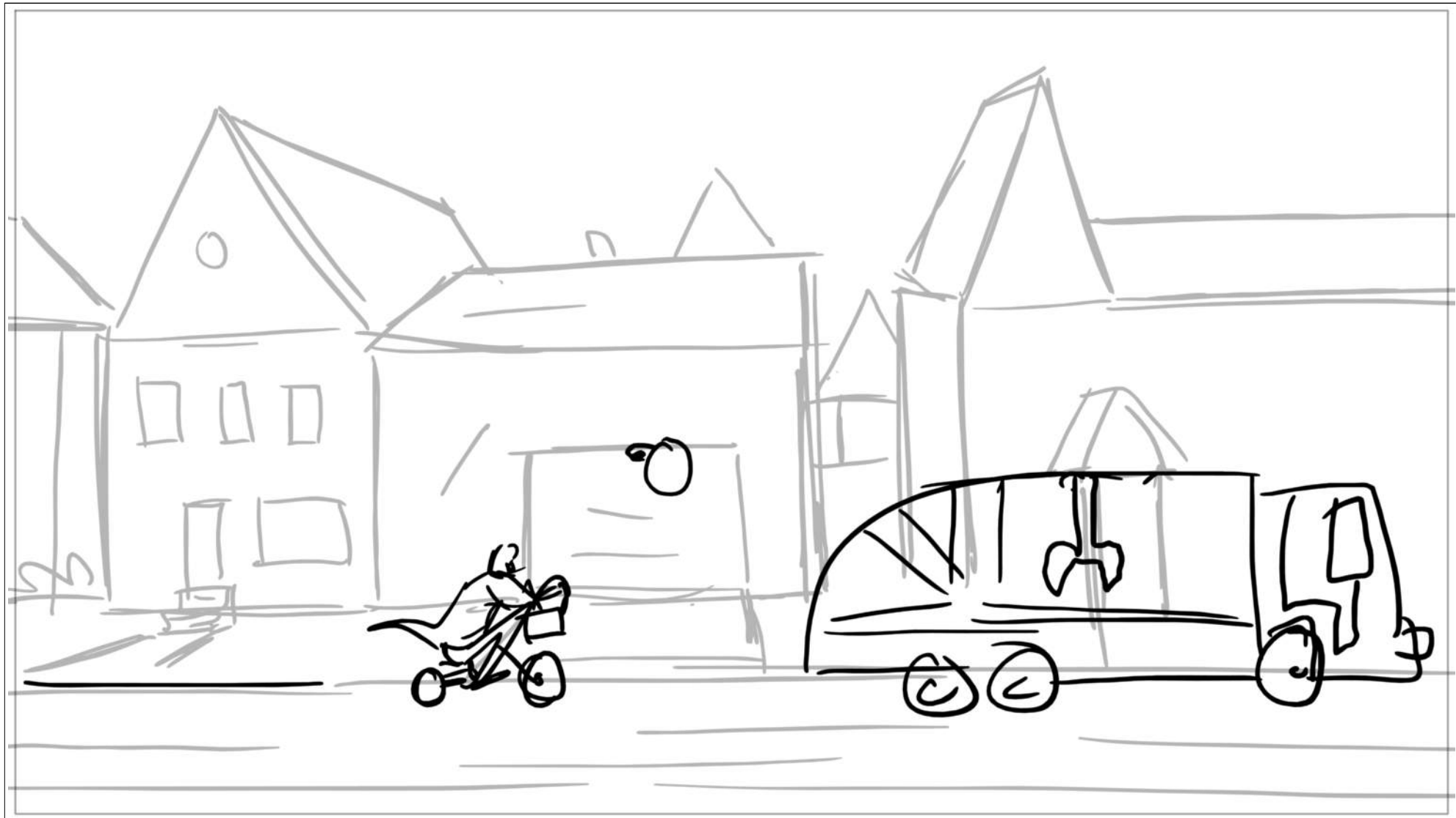

Scene	Duration	Panel	Duration
1	05:28:03	120	01:00

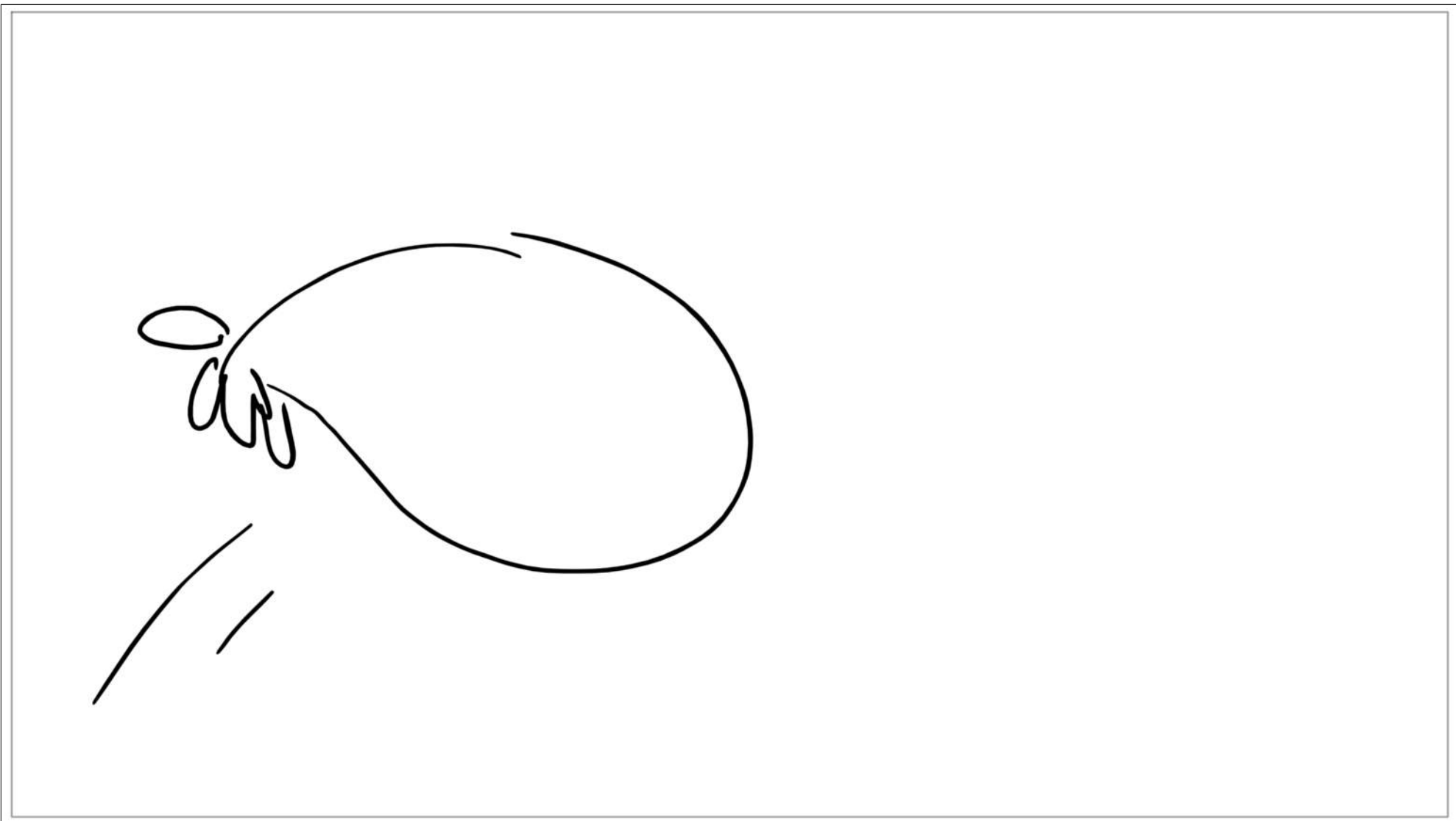

Scene	Duration	Panel	Duration
1	05:28:03	121	01:00

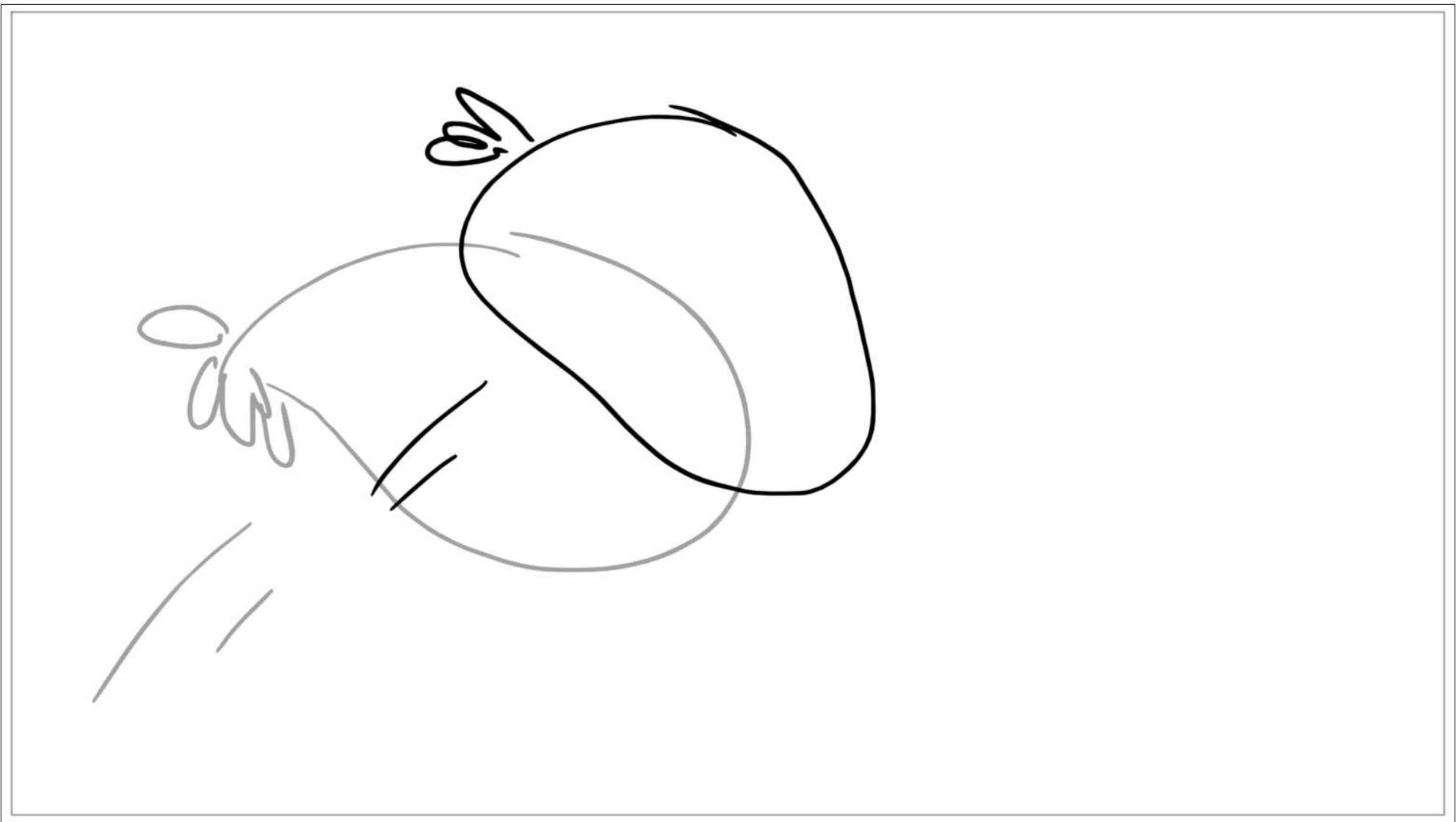

Scene	Duration	Panel	Duration
1	05:28:03	122	01:00

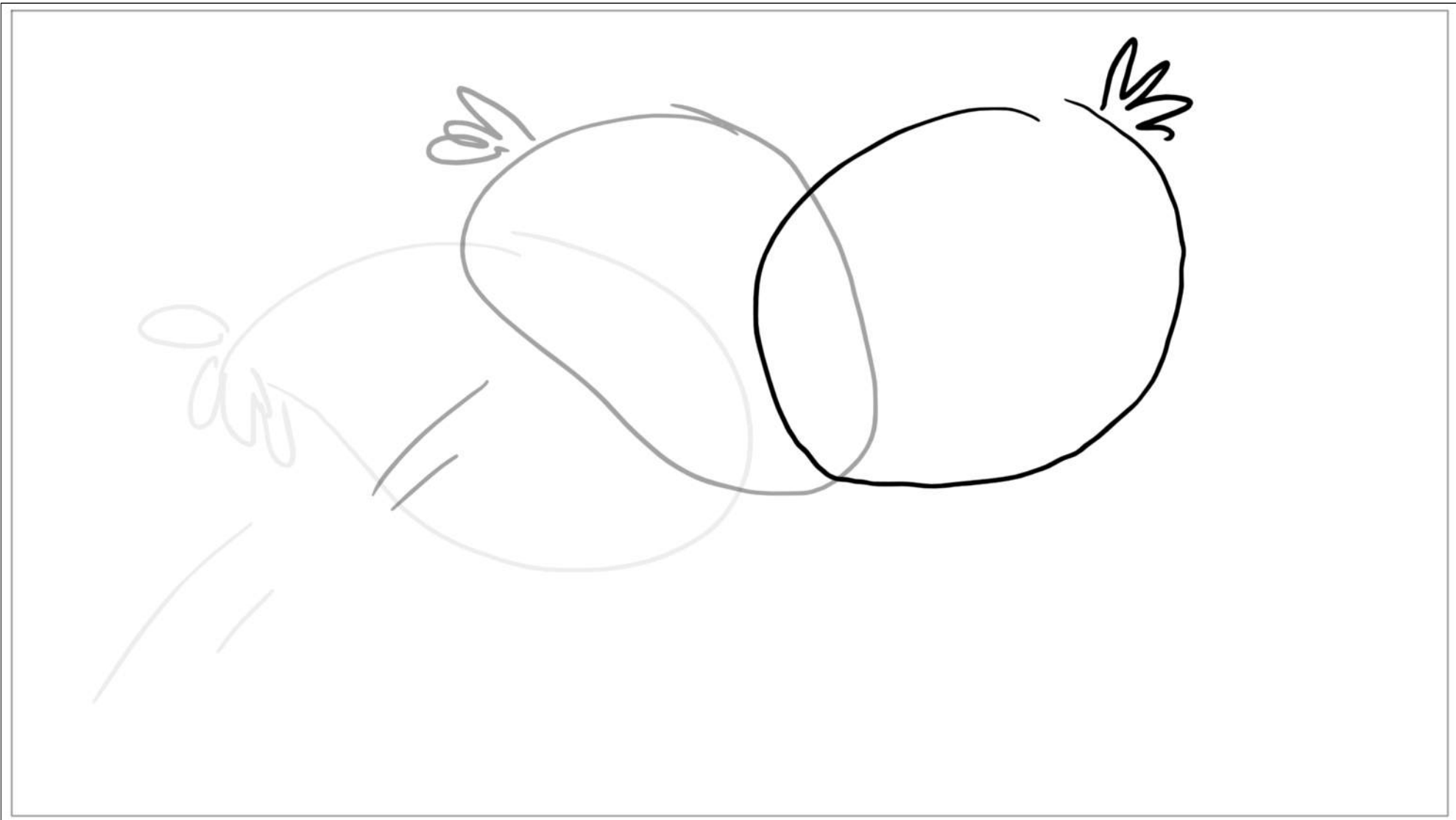

Scene	Duration	Panel	Duration
1	05:28:03	123	01:00



Scene	Duration	Panel	Duration
1	05:28:03	124	01:00

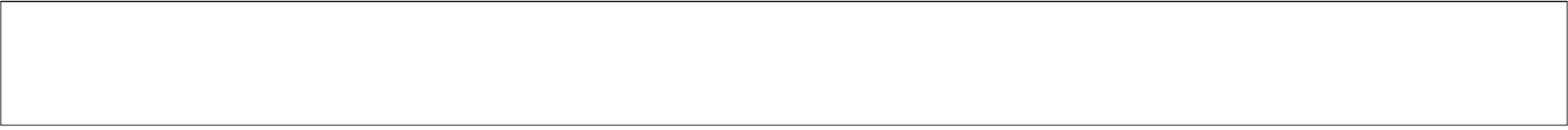

Scene	Duration	Panel	Duration
1	05:28:03	125	01:00



Scene	Duration	Panel	Duration
1	05:28:03	126	01:00

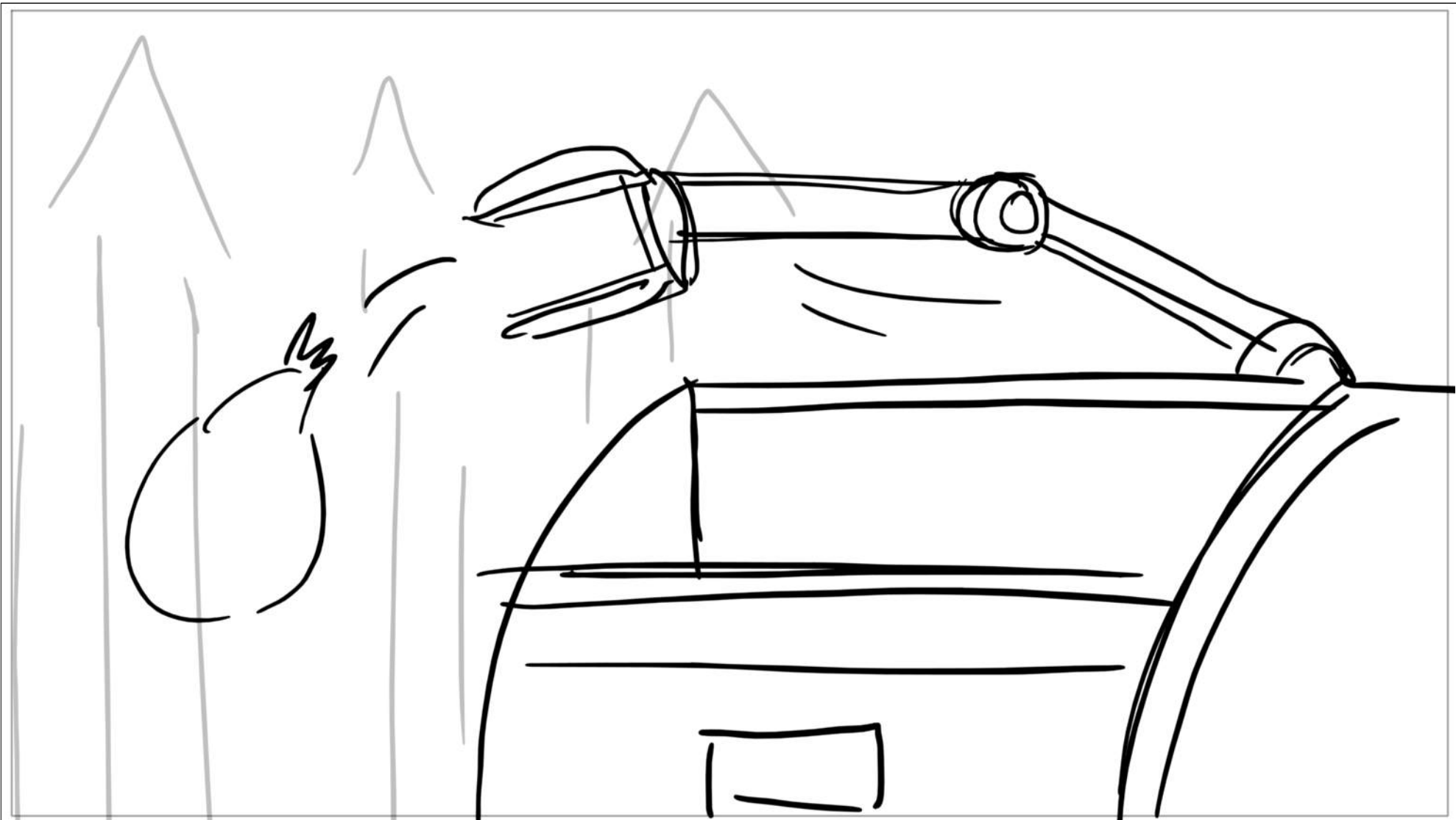

Scene	Duration	Panel	Duration
1	05:28:03	127	01:00

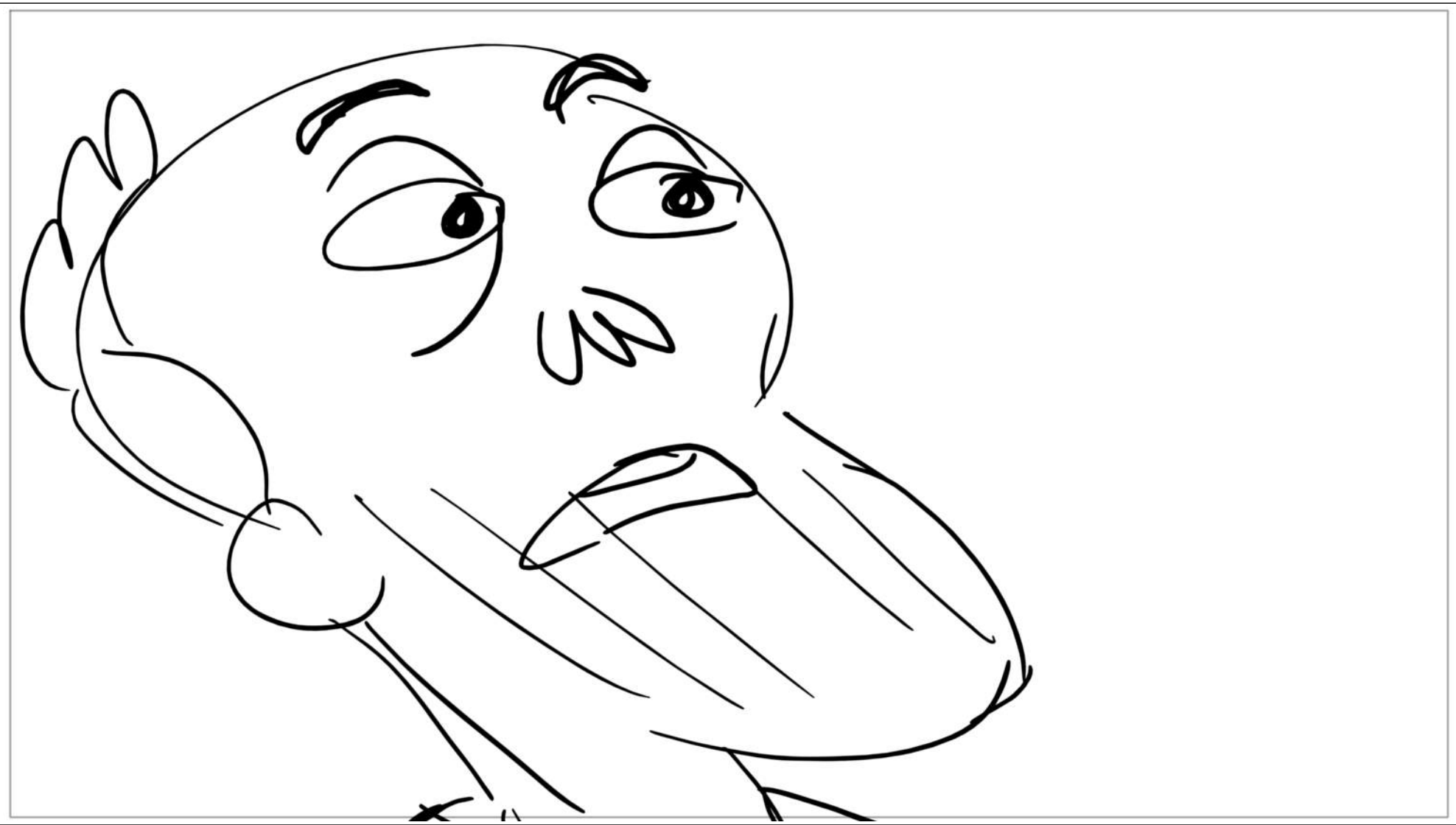

Scene	Duration	Panel	Duration
1	05:28:03	128	01:00



Scene	Duration	Panel	Duration
1	05:28:03	129	01:00



Scene	Duration	Panel	Duration
1	05:28:03	130	01:00



Scene	Duration	Panel	Duration
1	05:28:03	131	01:00



Scene	Duration	Panel	Duration
1	05:28:03	132	01:00

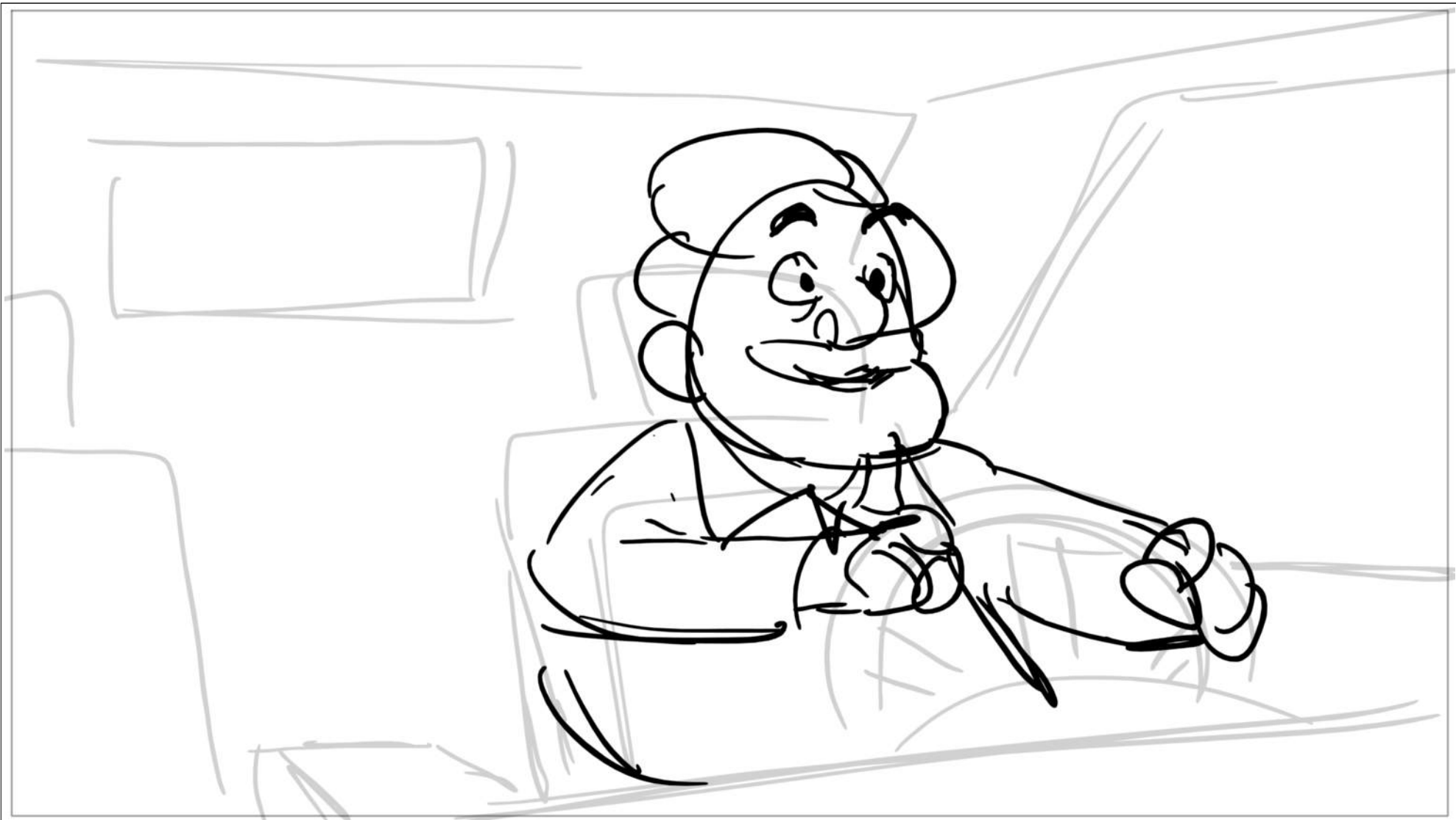

Scene	1	Duration	05:28:03	Panel	133	Duration	01:00
-------	---	----------	----------	-------	-----	----------	-------

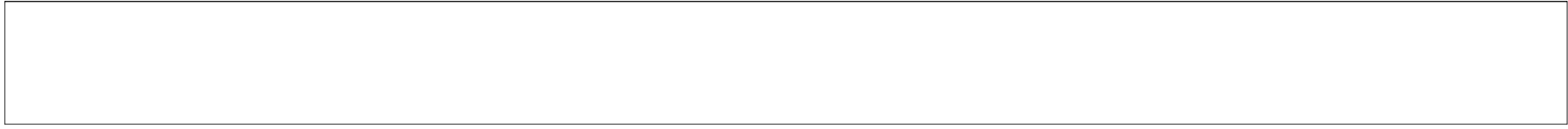
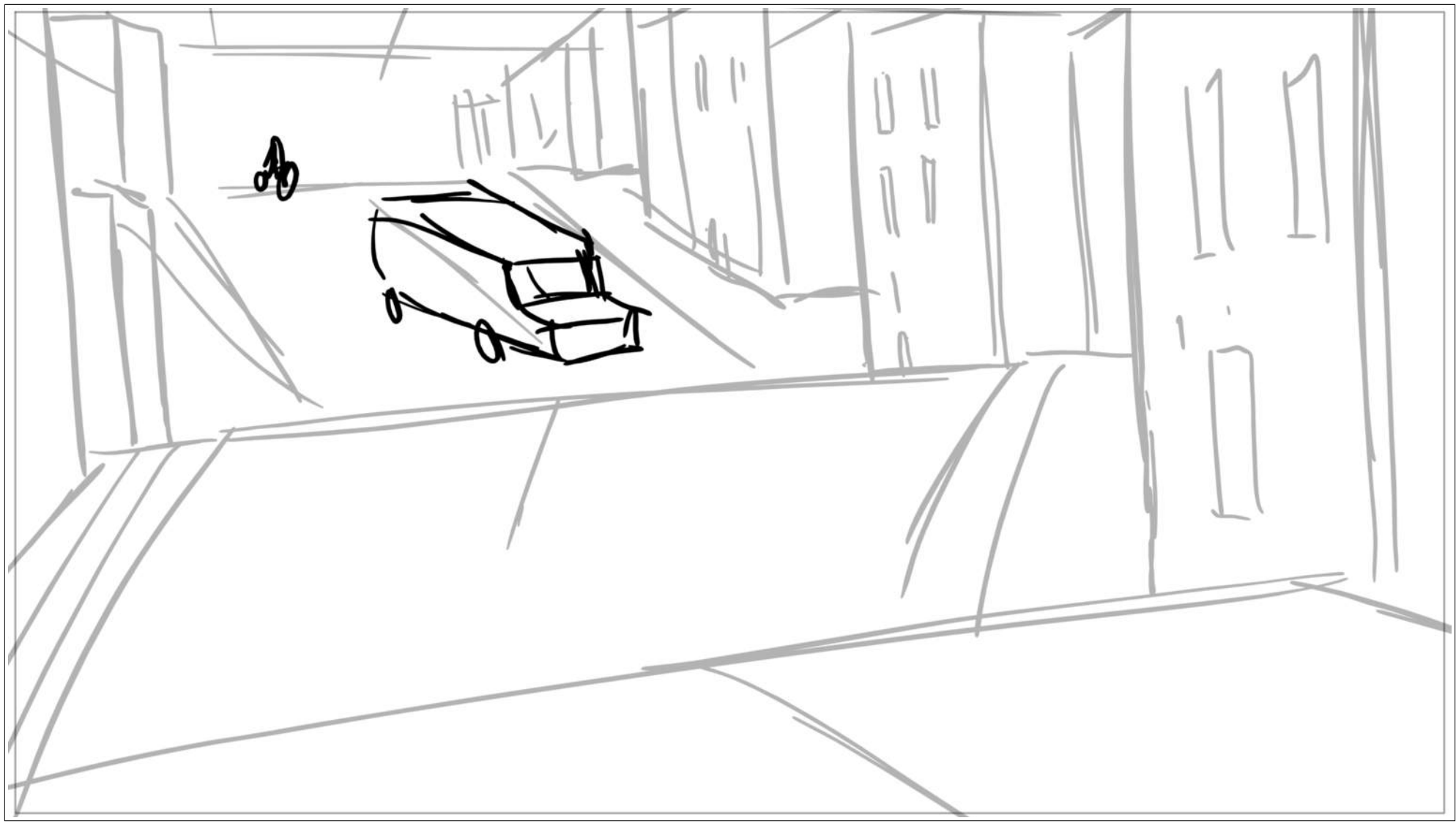

Scene	Duration	Panel	Duration
1	05:28:03	134	01:00

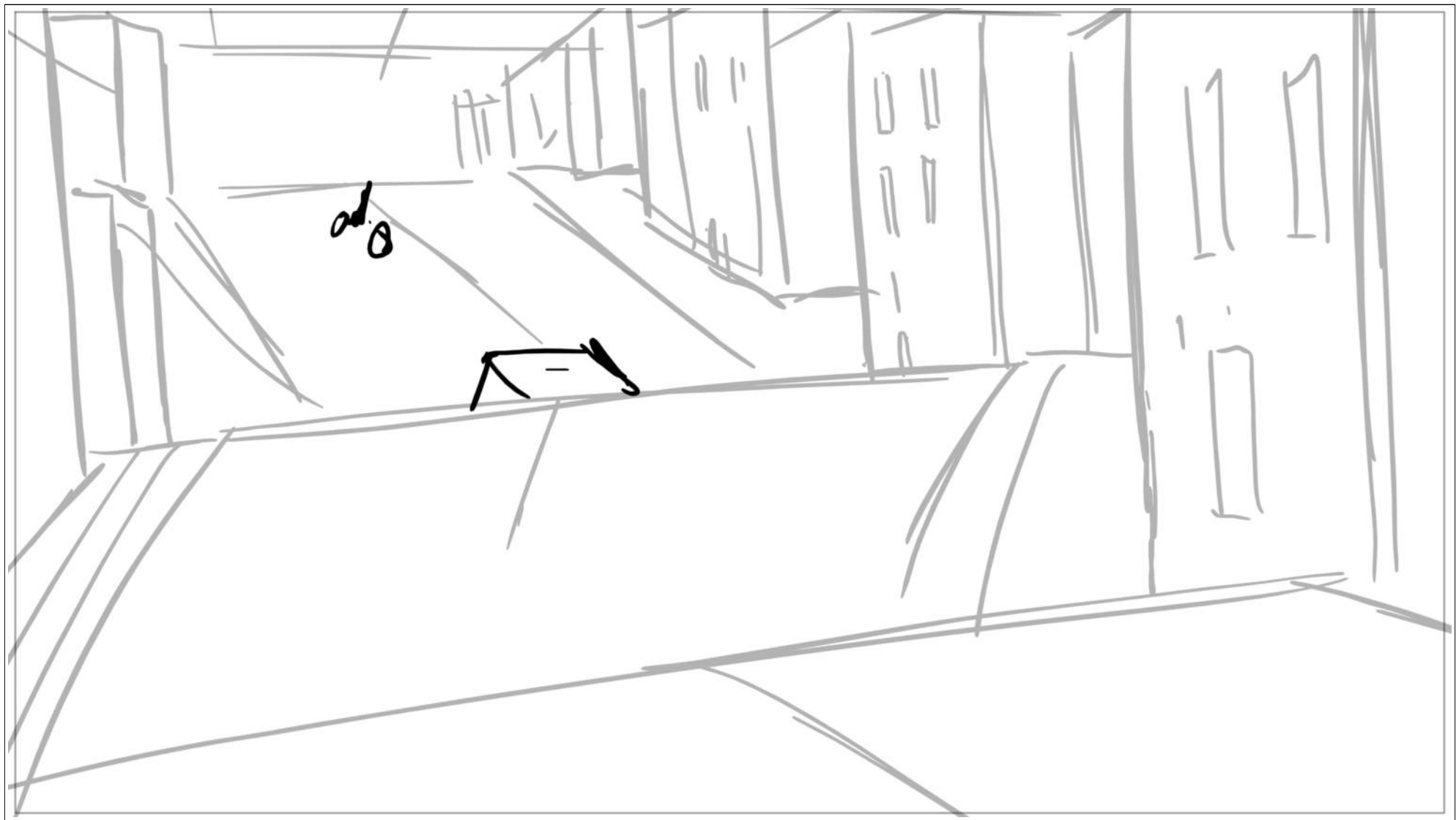

Scene	Duration	Panel	Duration
1	05:28:03	135	01:00

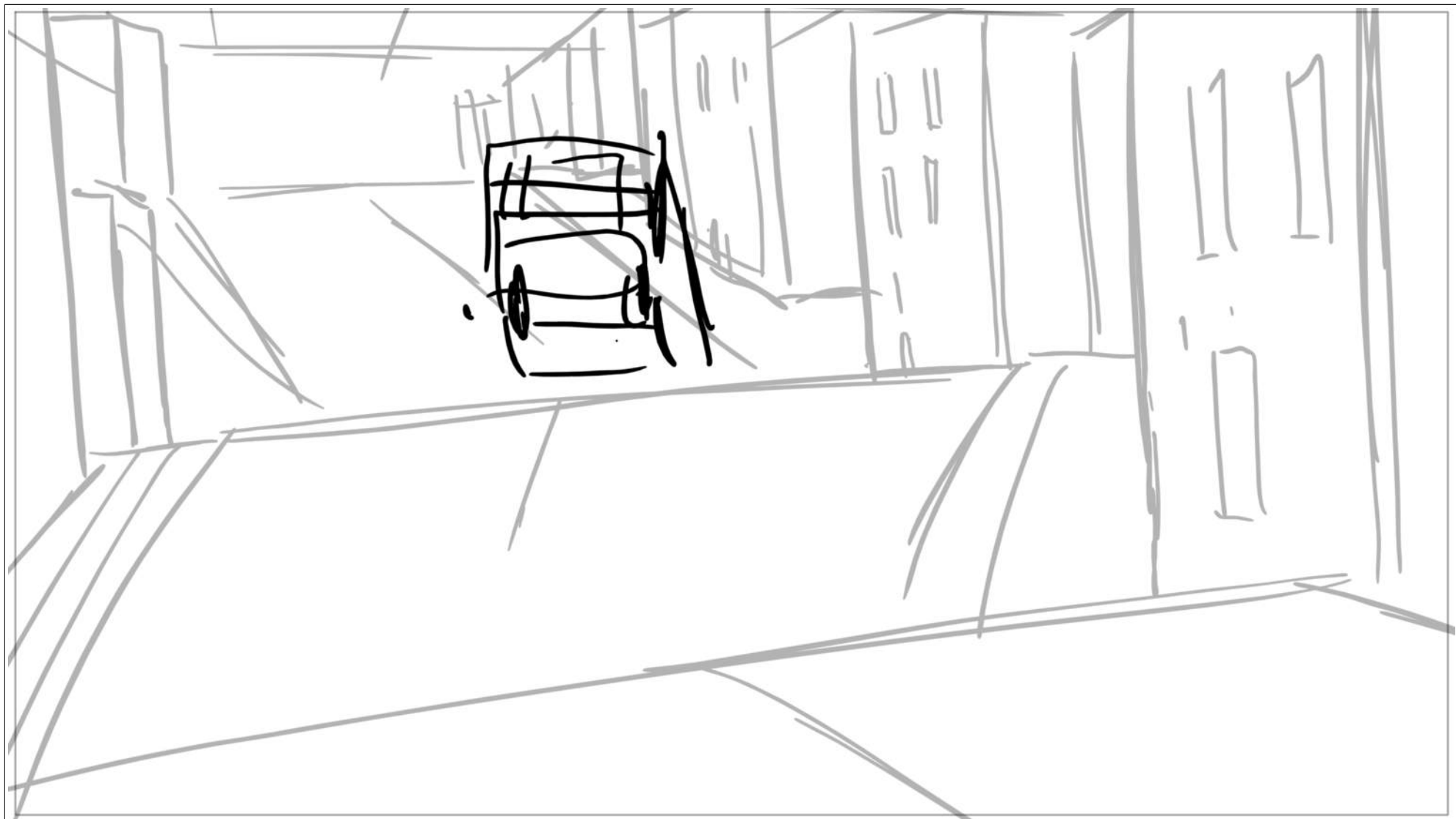

Scene	Duration	Panel	Duration
1	05:28:03	136	01:00

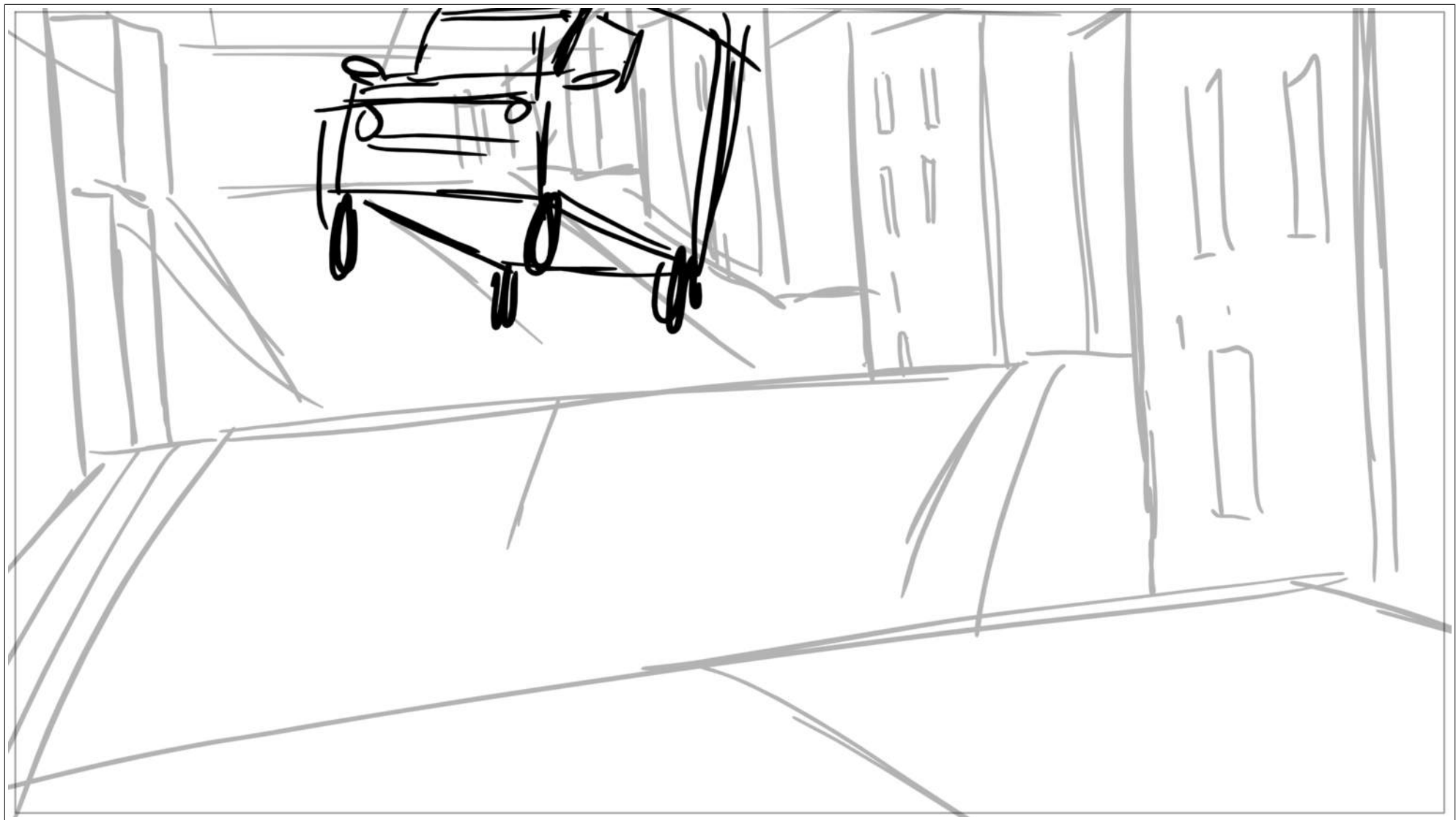

Scene	Duration	Panel	Duration
1	05:28:03	137	01:00

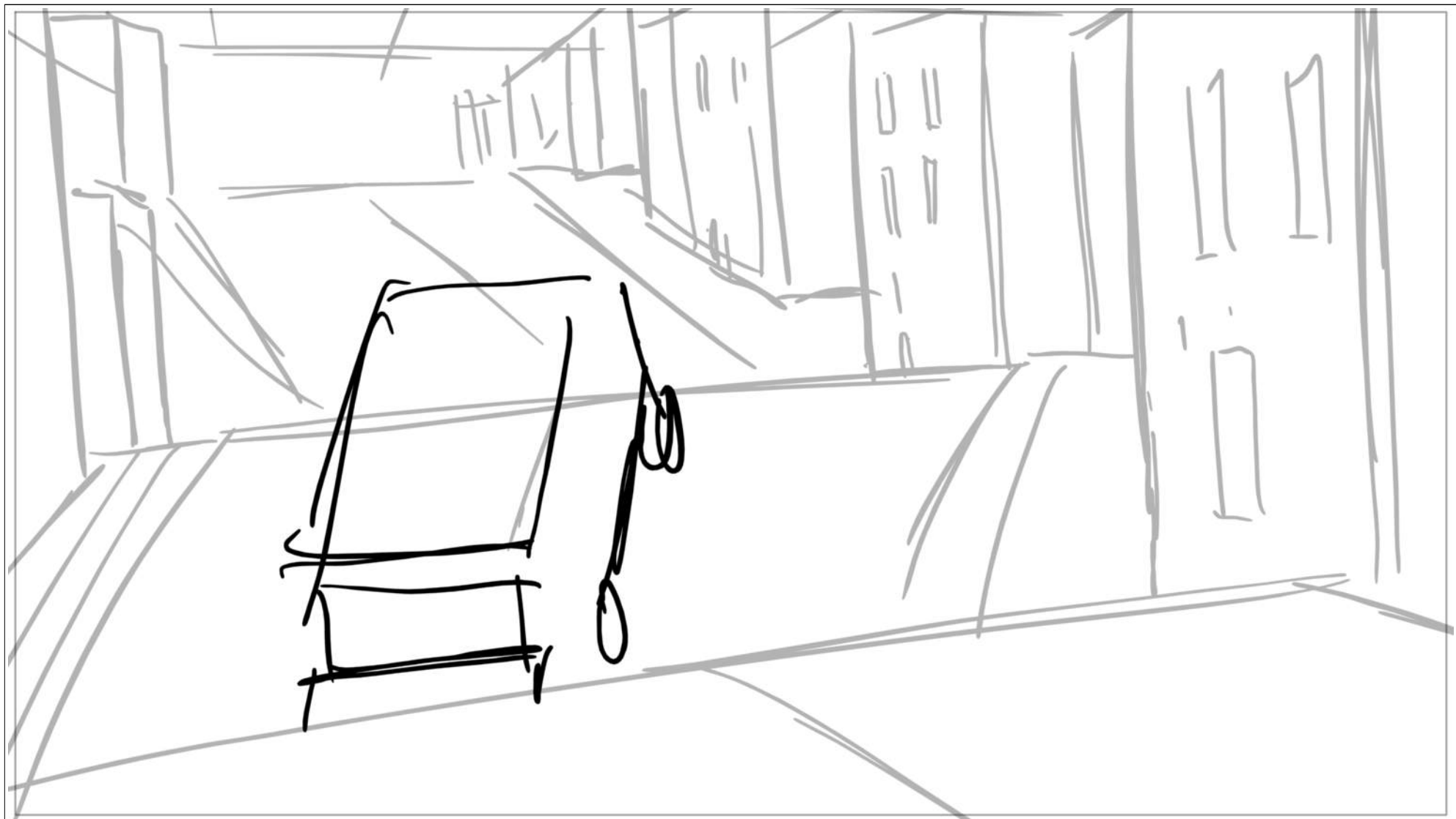

Scene	Duration	Panel	Duration
1	05:28:03	138	01:00

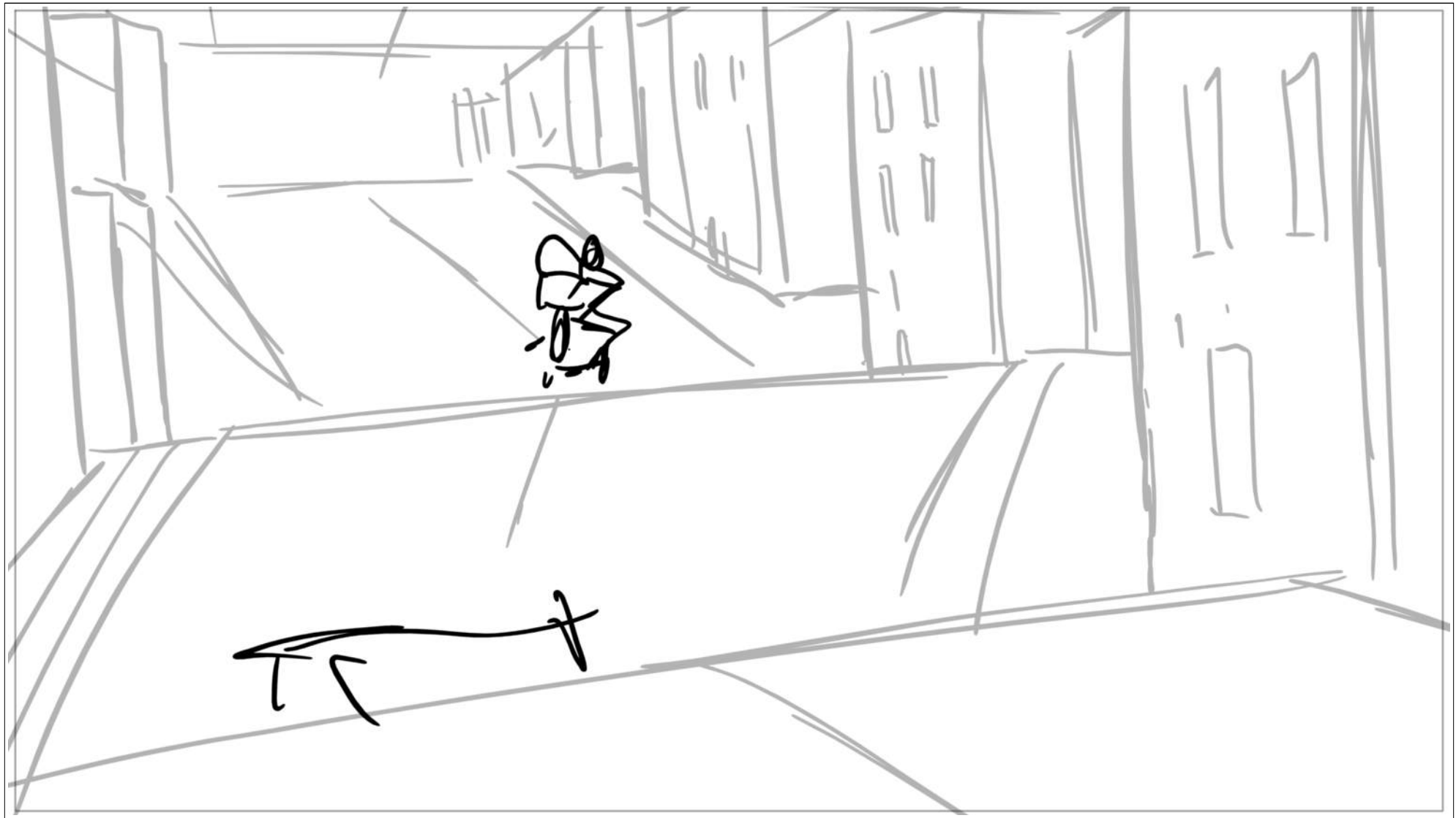

Scene	1	Duration	05:28:03	Panel	139	Duration	01:00
-------	---	----------	----------	-------	-----	----------	-------

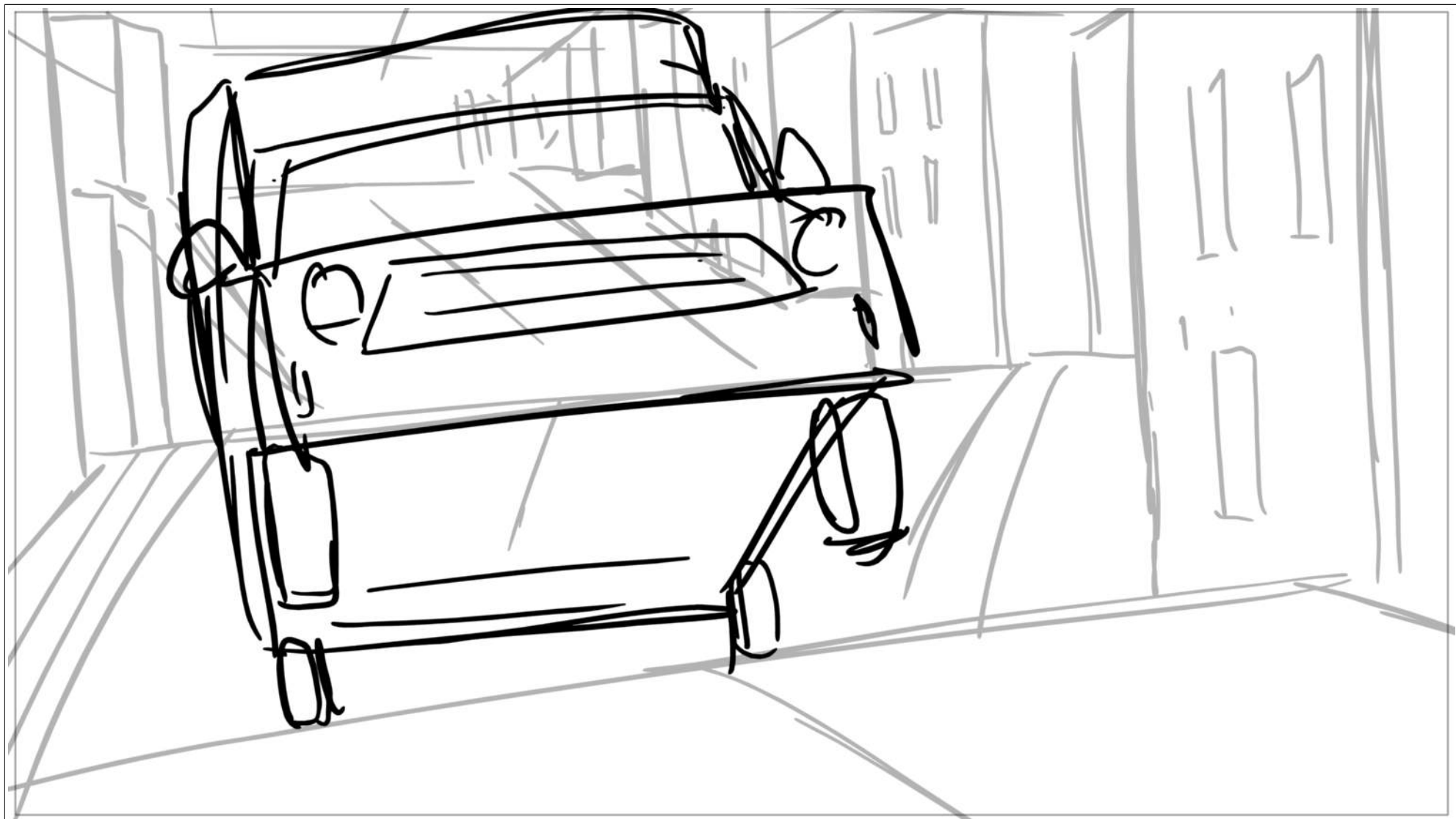

Scene	Duration	Panel	Duration
1	05:28:03	140	01:00

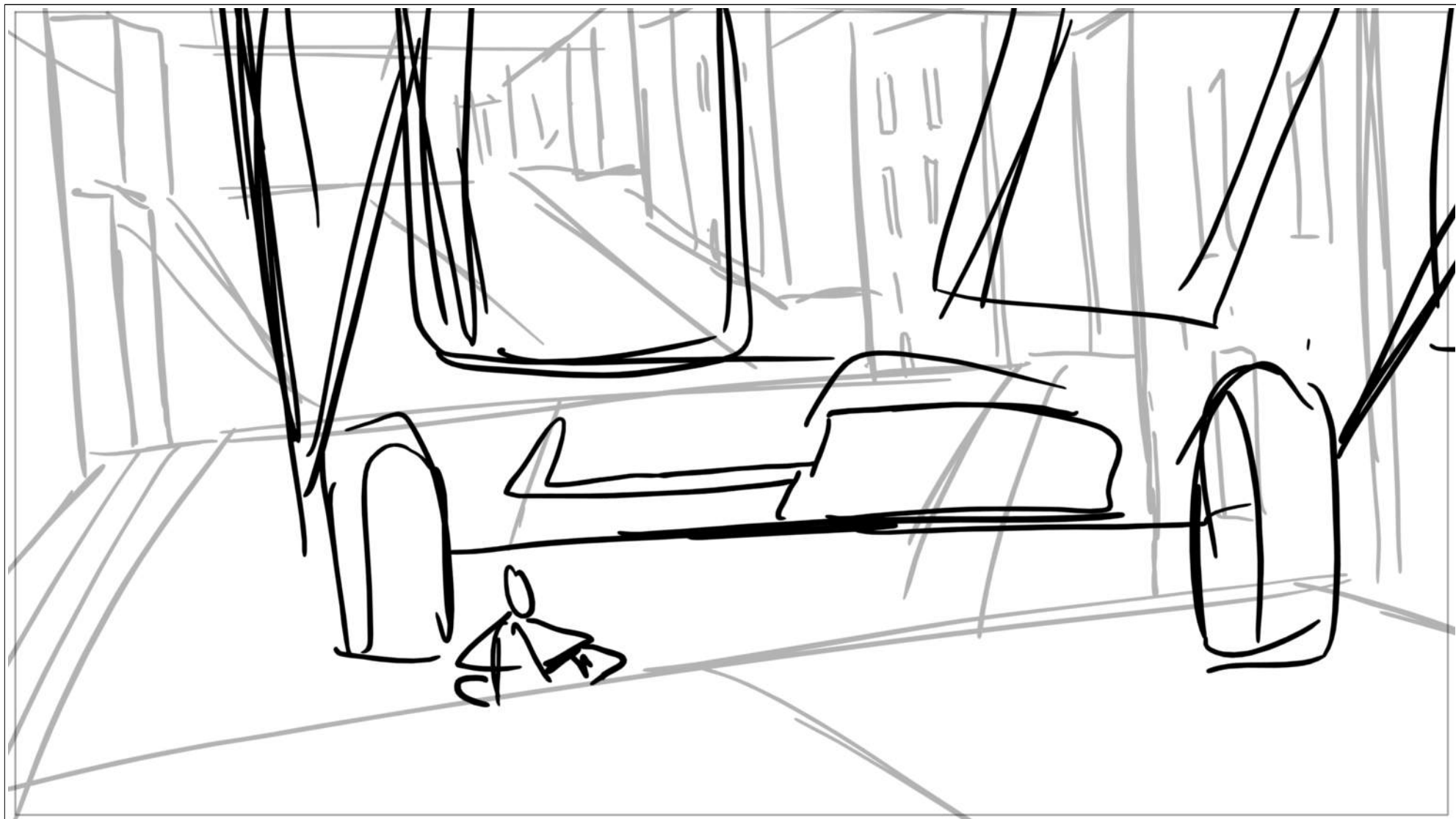

Scene	Duration	Panel	Duration
1	05:28:03	141	01:00

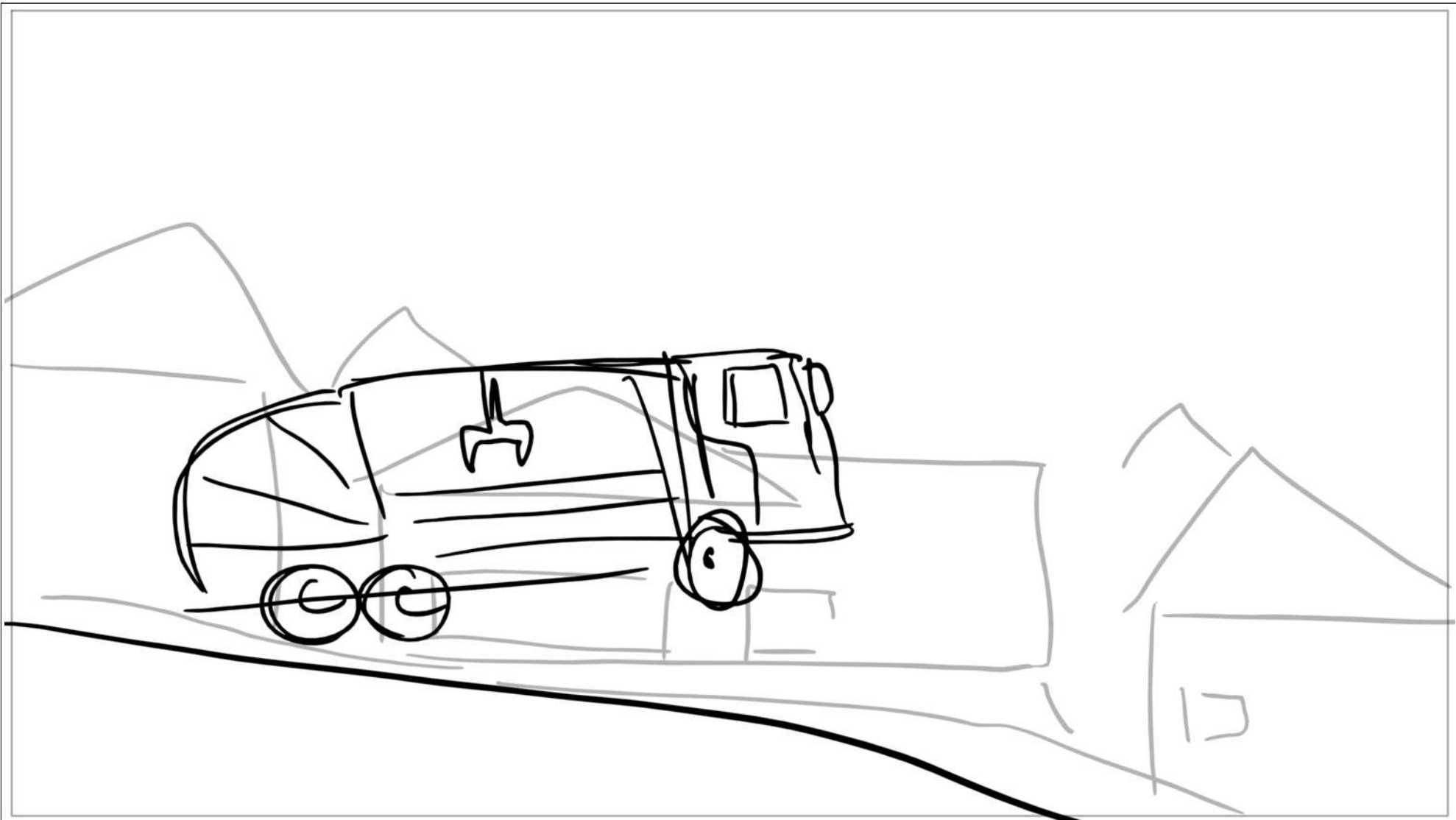

Scene	Duration	Panel	Duration
1	05:28:03	142	01:00



Scene	1	Duration	05:28:03	Panel	143	Duration	01:00
-------	---	----------	----------	-------	-----	----------	-------

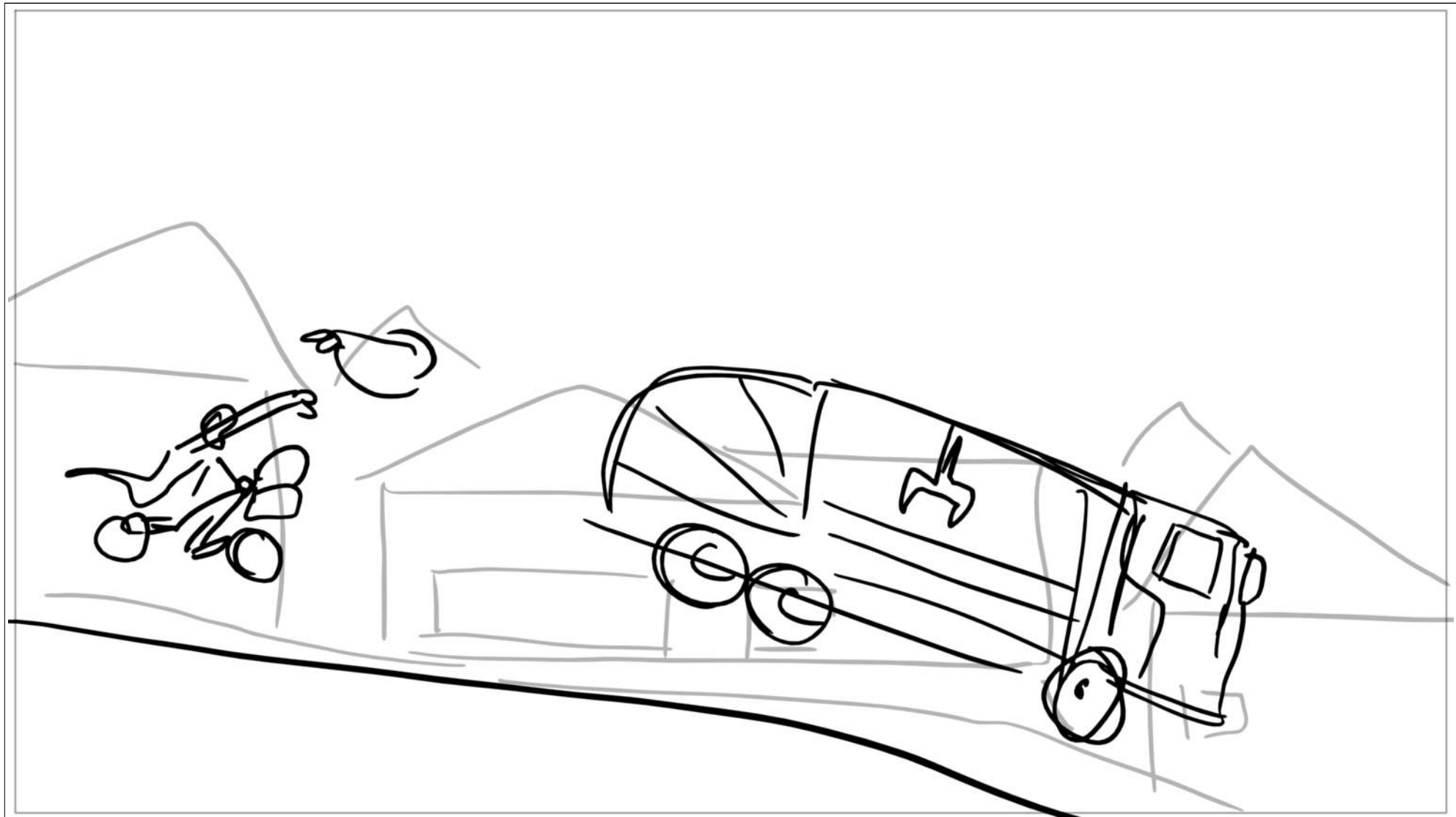

Scene	Duration	Panel	Duration
1	05:28:03	144	01:00



Scene	Duration	Panel	Duration
1	05:28:03	145	01:00

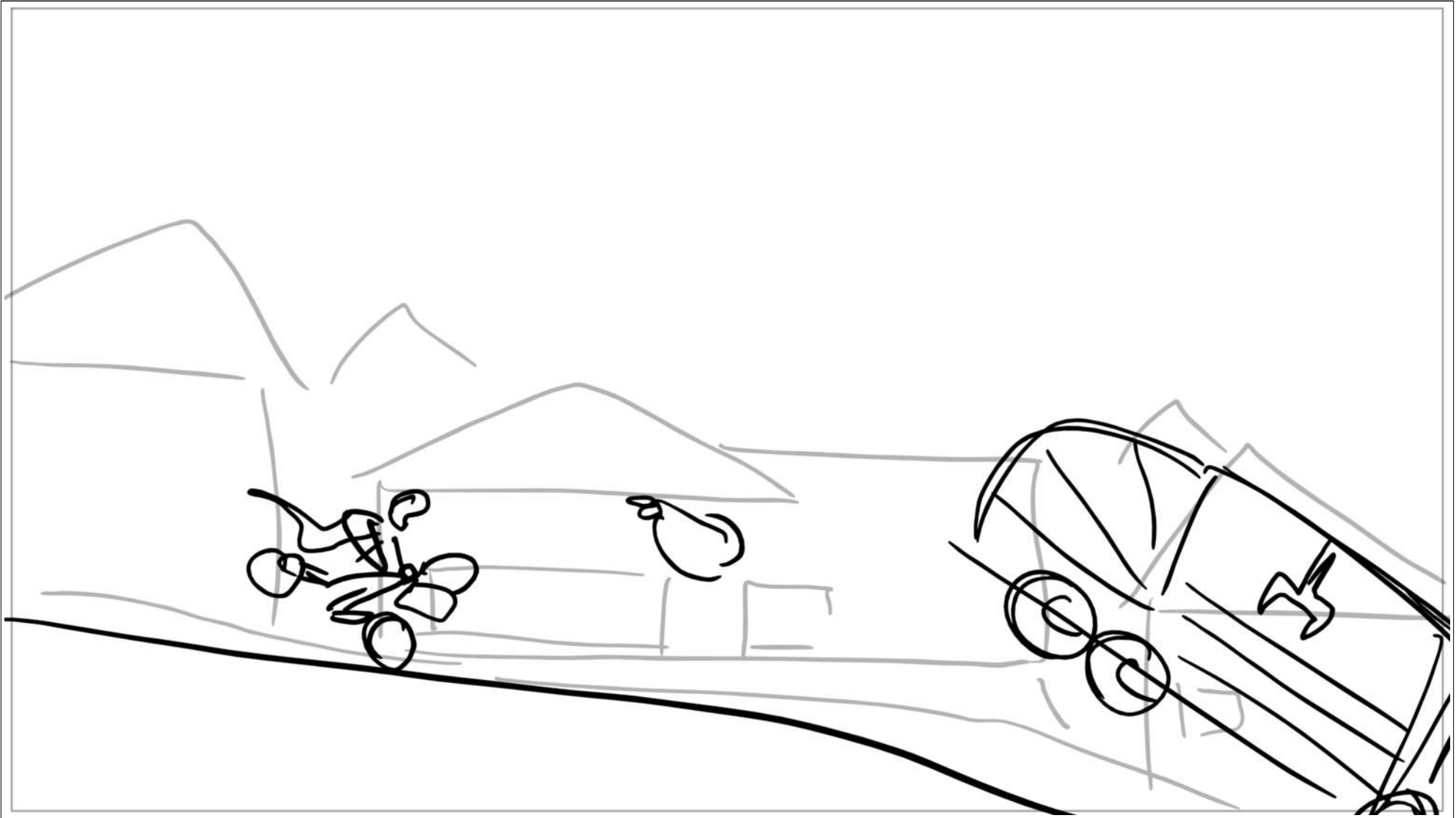

Scene	Duration	Panel	Duration
1	05:28:03	146	01:00

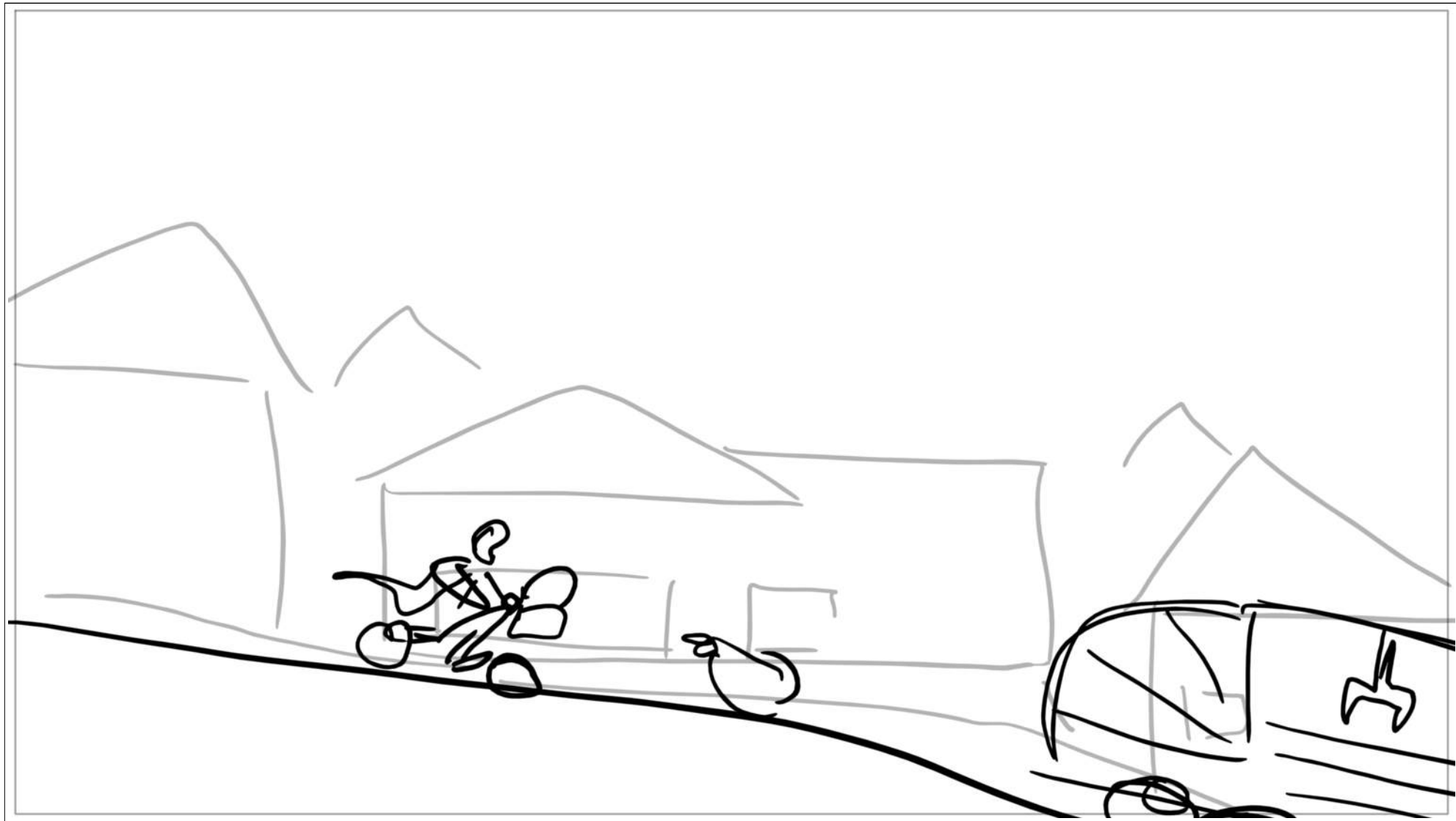

Scene	Duration	Panel	Duration
1	05:28:03	147	01:00

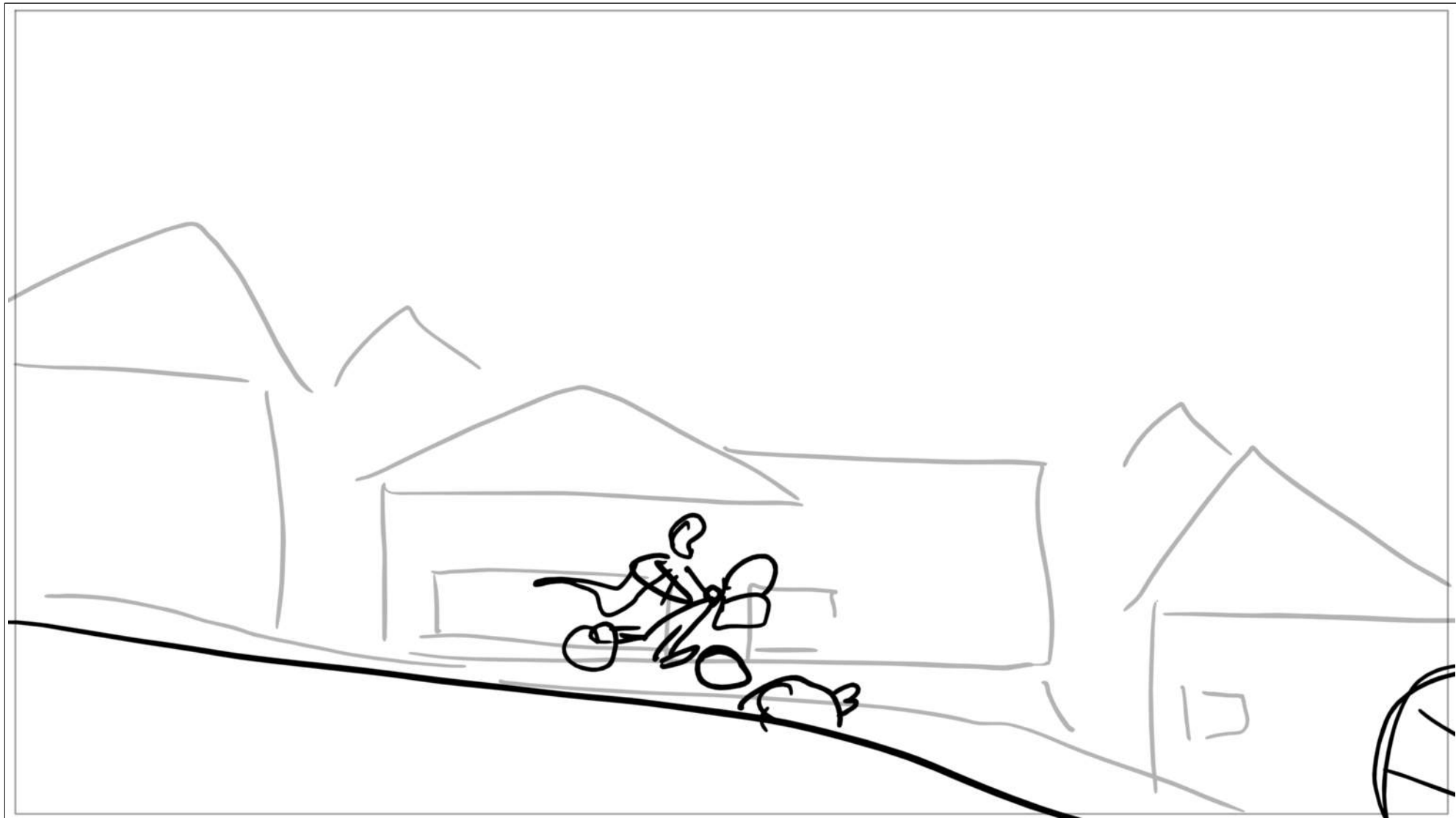

Scene	Duration	Panel	Duration
1	05:28:03	148	01:00



Scene	Duration	Panel	Duration
1	05:28:03	149	01:00

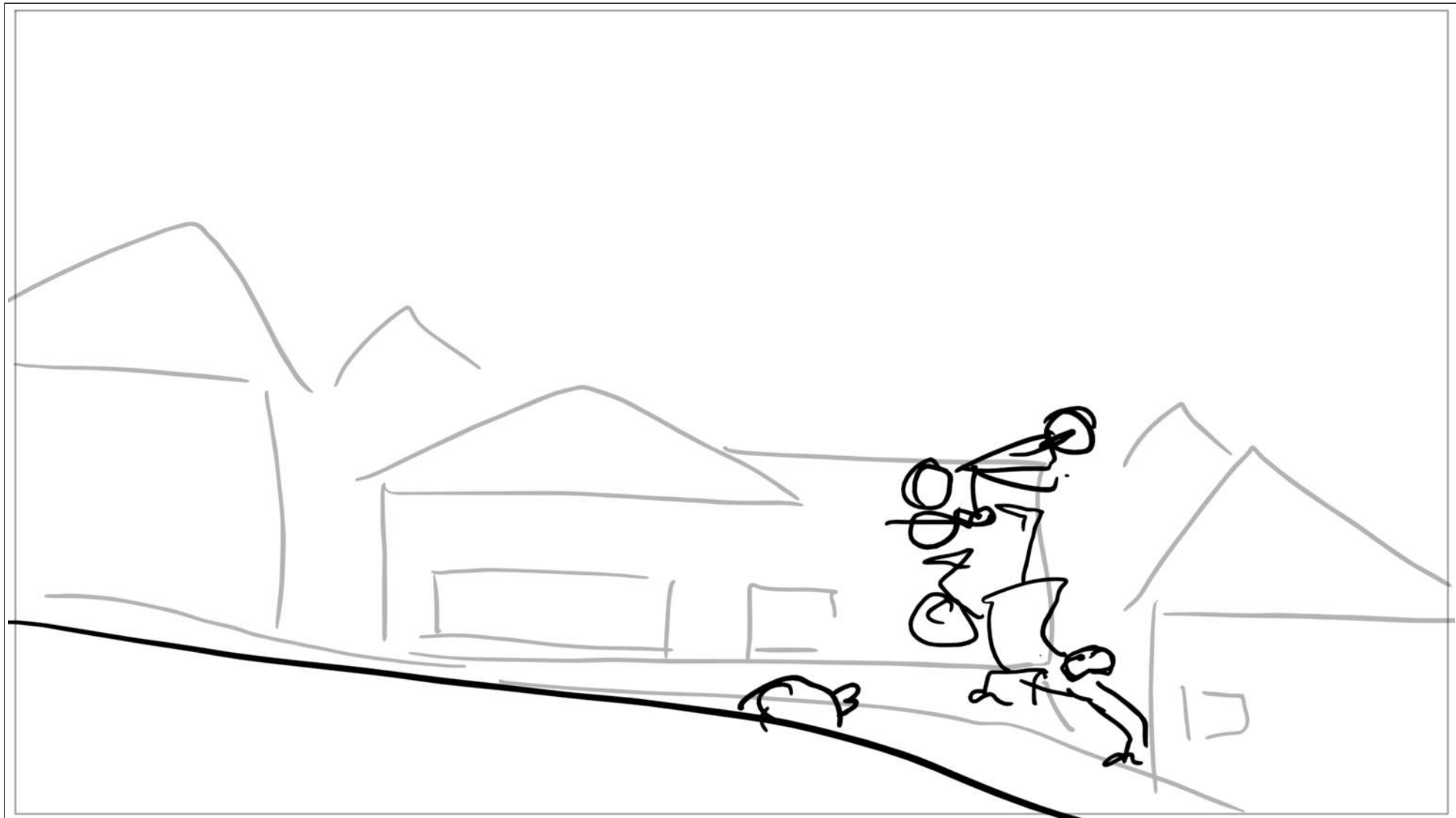

Scene	Duration	Panel	Duration
1	05:28:03	150	01:00

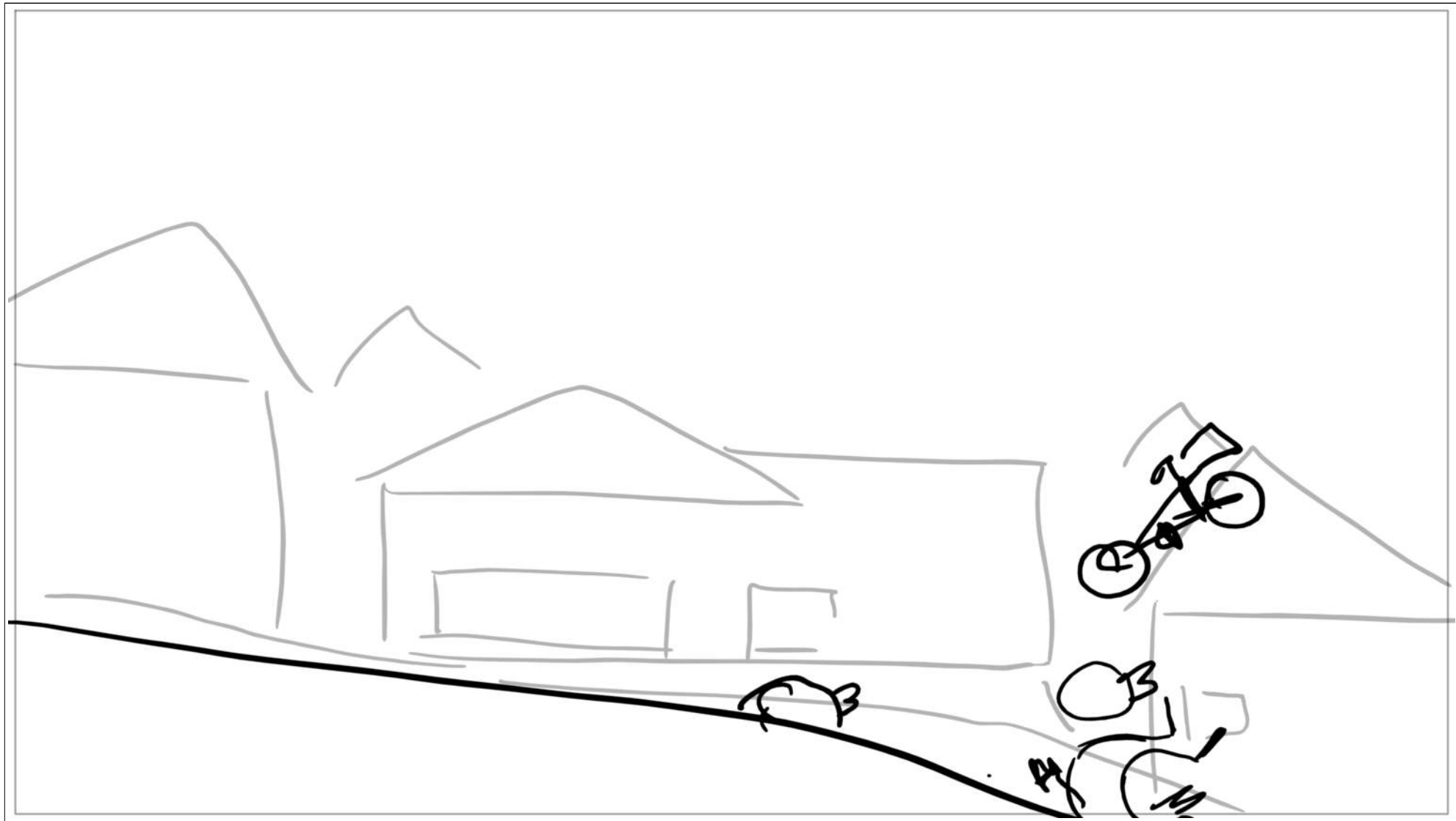

Scene	Duration	Panel	Duration
1	05:28:03	151	01:00



Scene	Duration	Panel	Duration
1	05:28:03	152	01:00

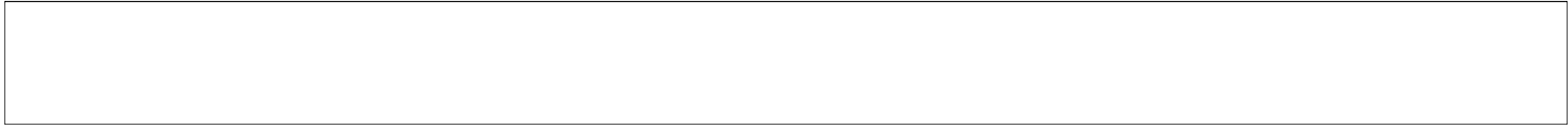

Scene	Duration	Panel	Duration
1	05:28:03	153	01:00

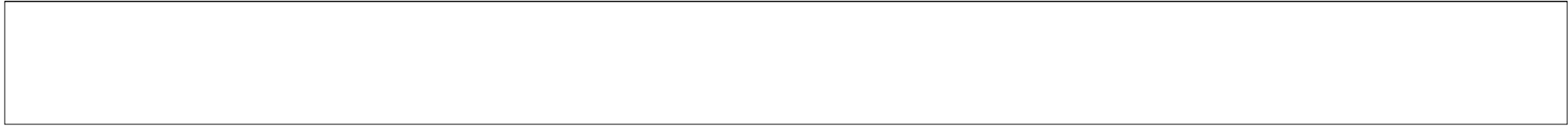

Scene	Duration	Panel	Duration
1	05:28:03	154	01:00



Scene	Duration	Panel	Duration
1	05:28:03	155	01:00



Scene	Duration	Panel	Duration
1	05:28:03	156	01:00

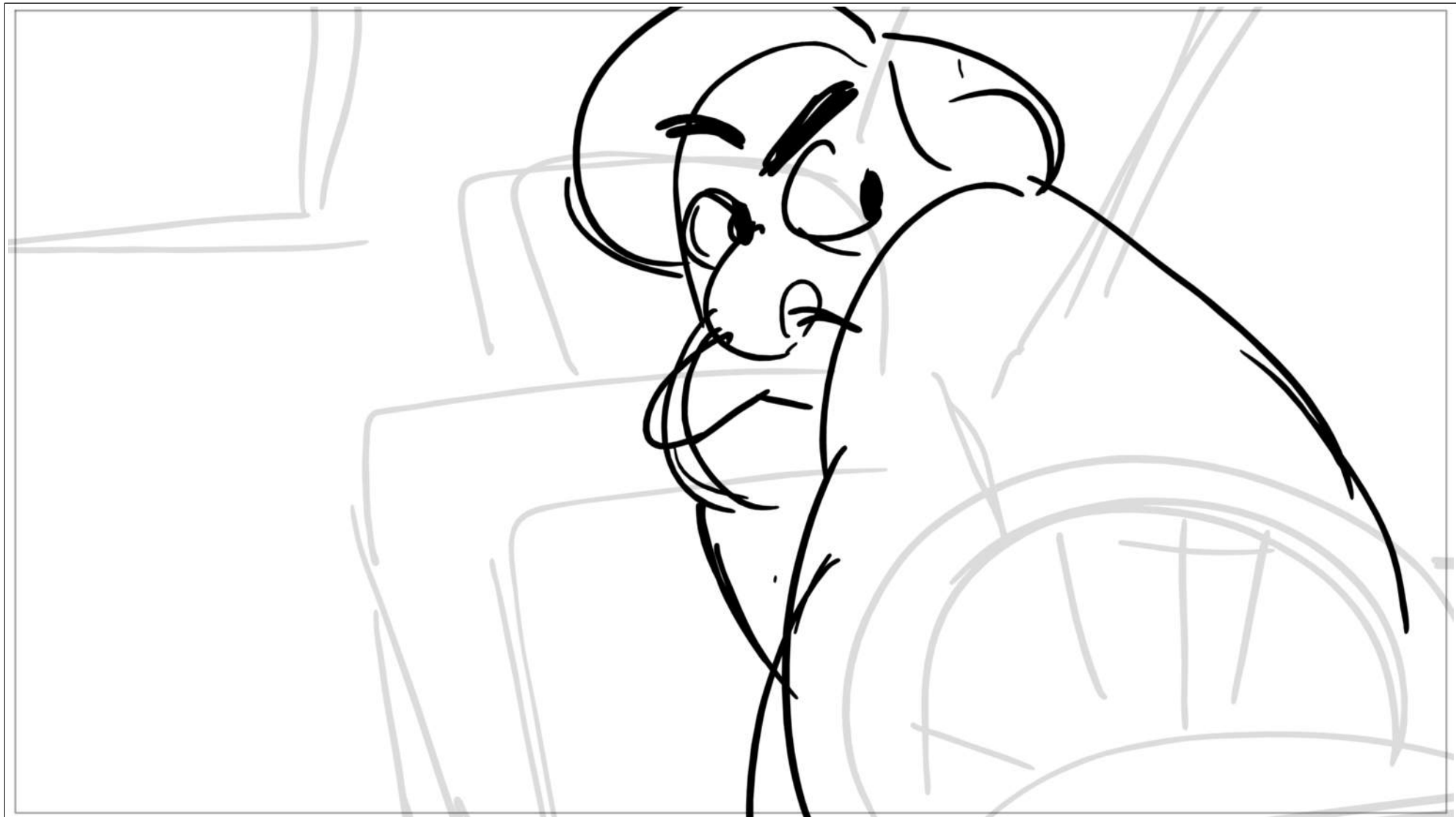

Scene	Duration	Panel	Duration
1	05:28:03	157	01:00

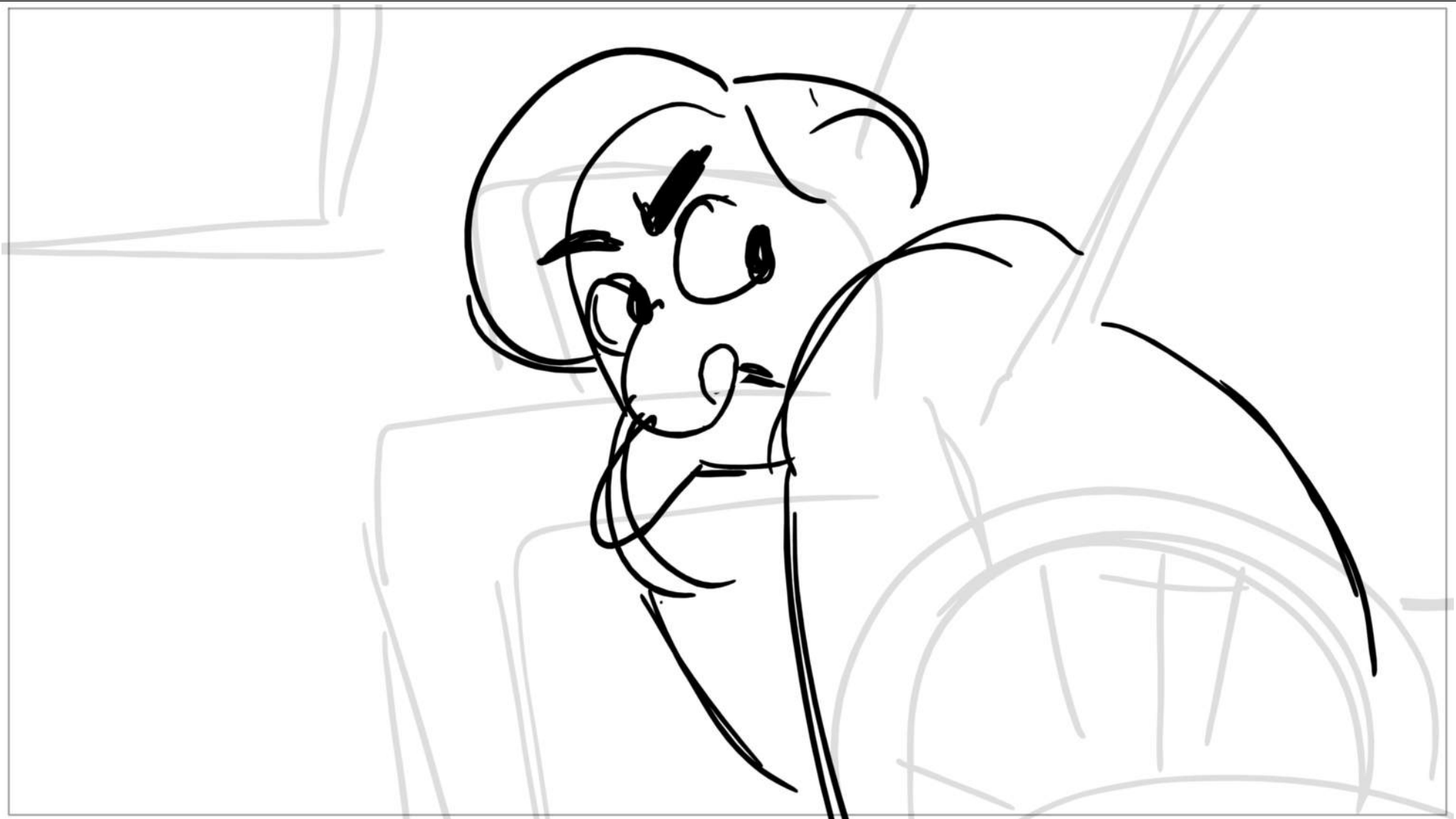

Scene	Duration	Panel	Duration
1	05:28:03	158	01:00

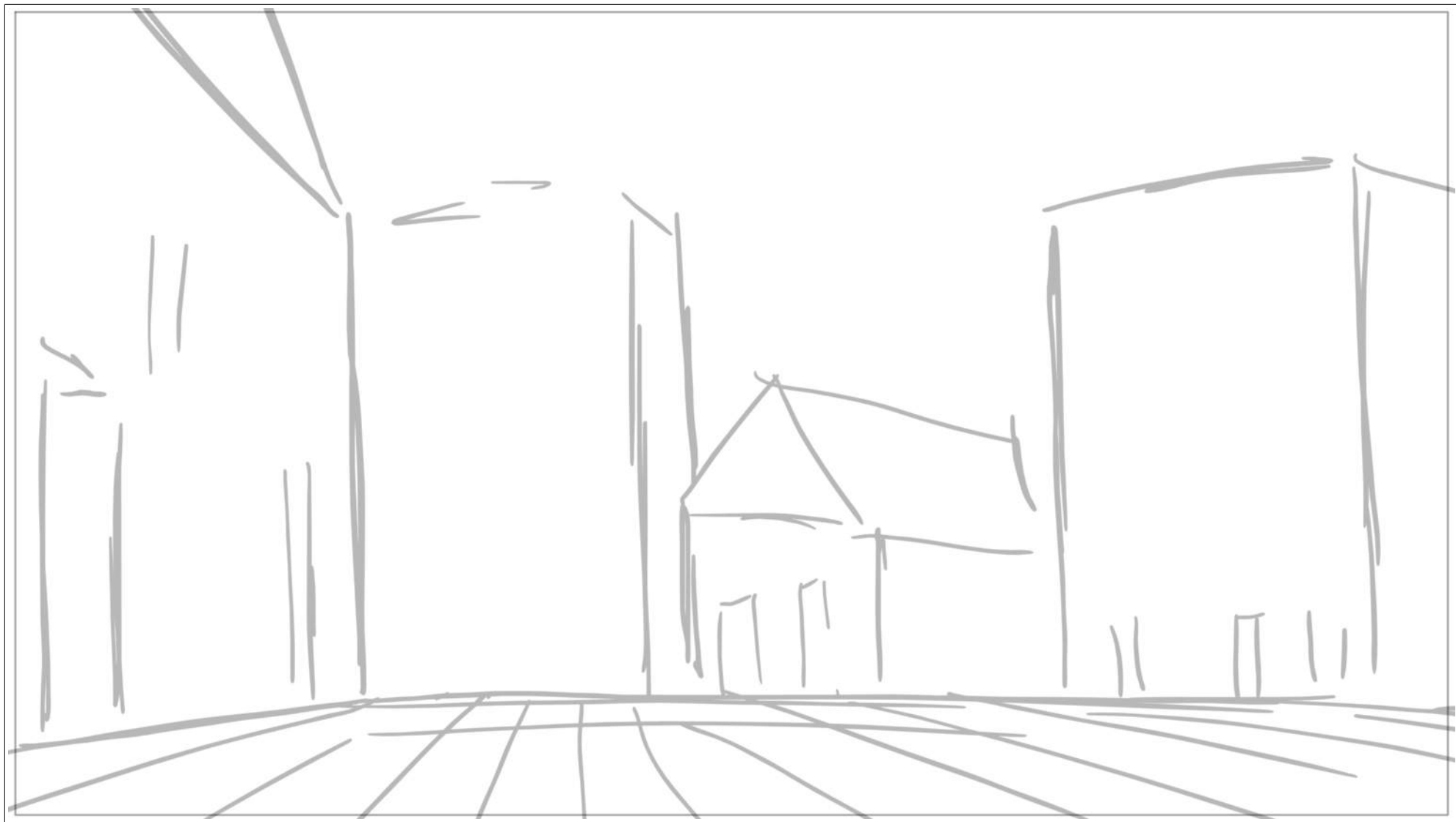

Scene	Duration	Panel	Duration
1	05:28:03	159	01:00



Scene	Duration	Panel	Duration
1	05:28:03	160	01:00

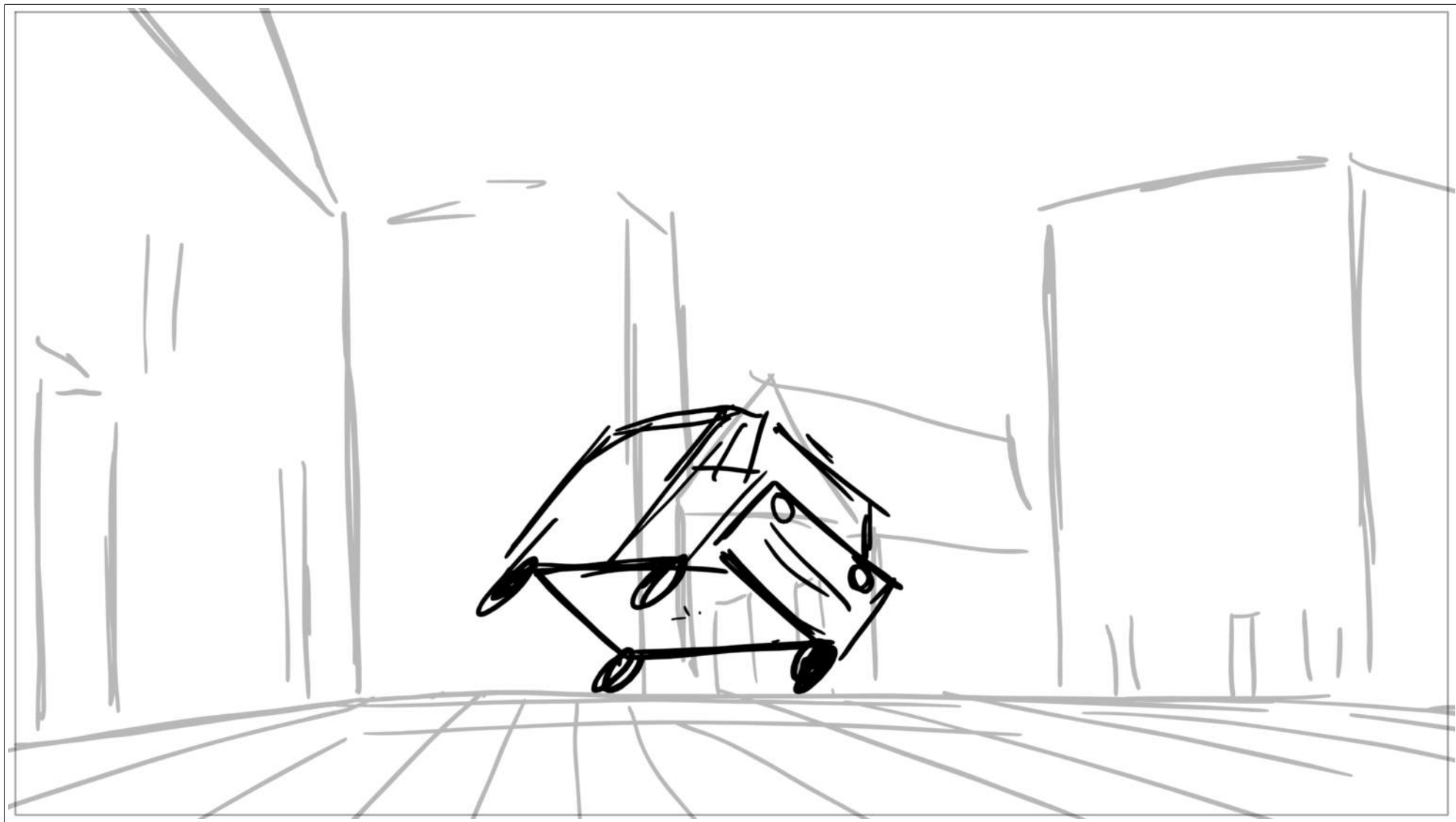

Scene	Duration	Panel	Duration
1	05:28:03	161	01:00

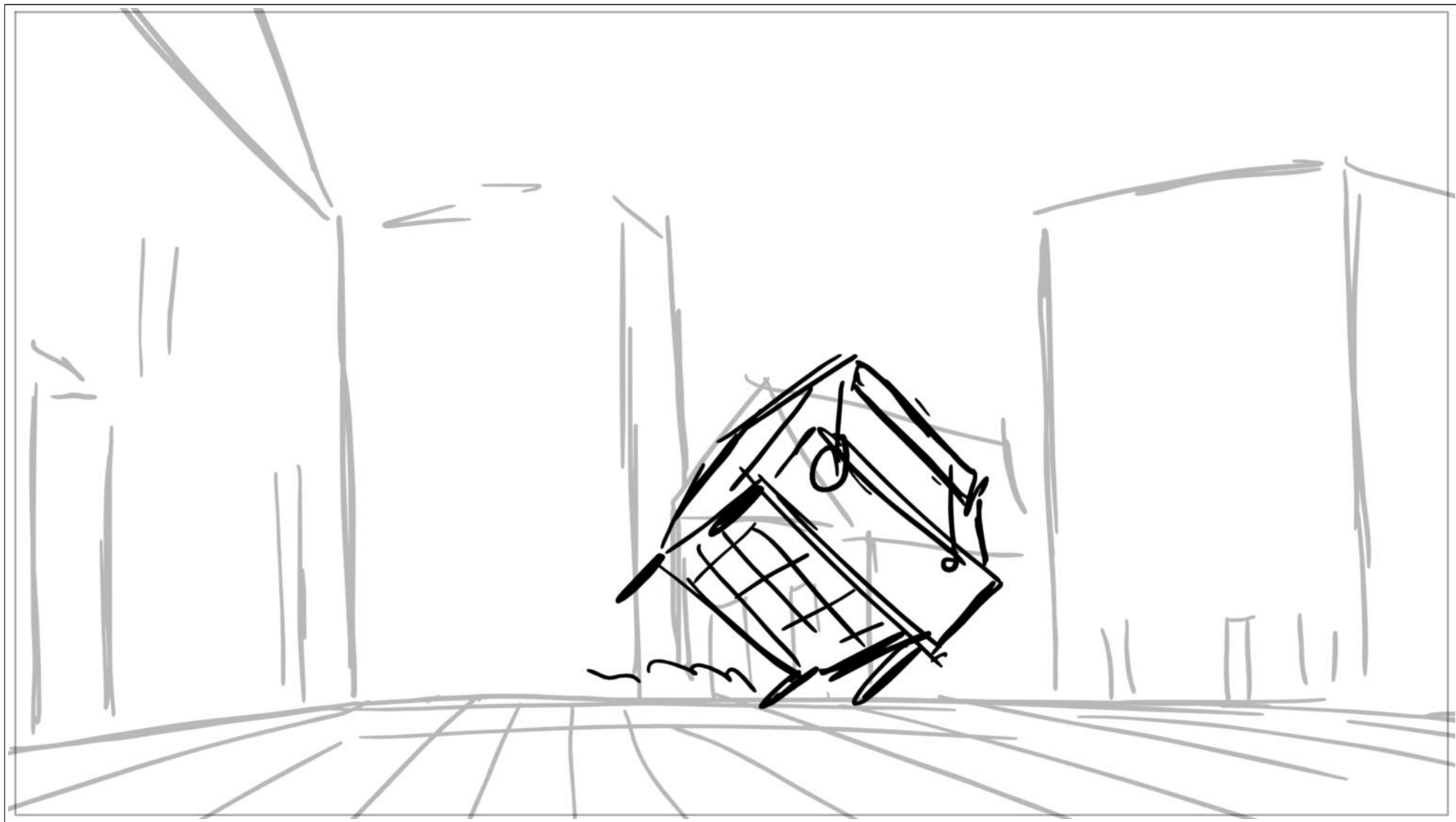

Scene	Duration	Panel	Duration
1	05:28:03	162	01:00

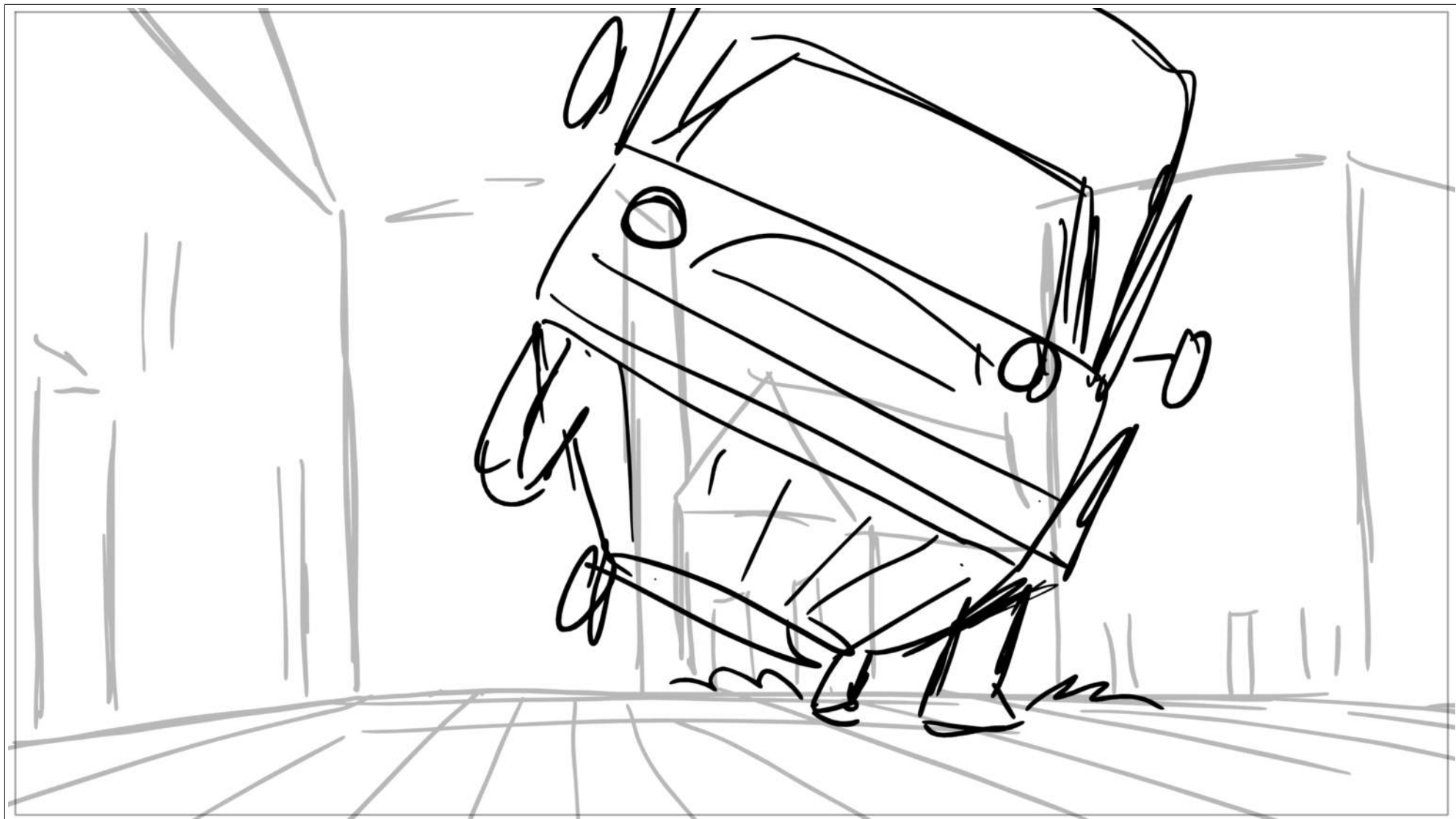

Scene	Duration	Panel	Duration
1	05:28:03	163	01:00

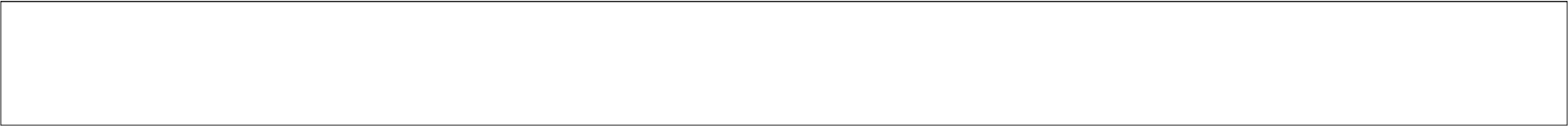

Scene	Duration	Panel	Duration
1	05:28:03	164	01:00

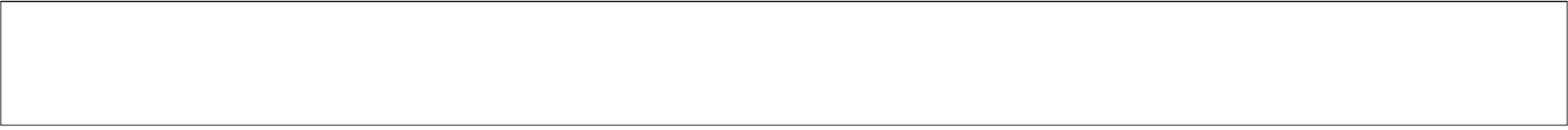

Scene	Duration	Panel	Duration
1	05:28:03	165	01:00



Scene	Duration	Panel	Duration
1	05:28:03	166	01:00

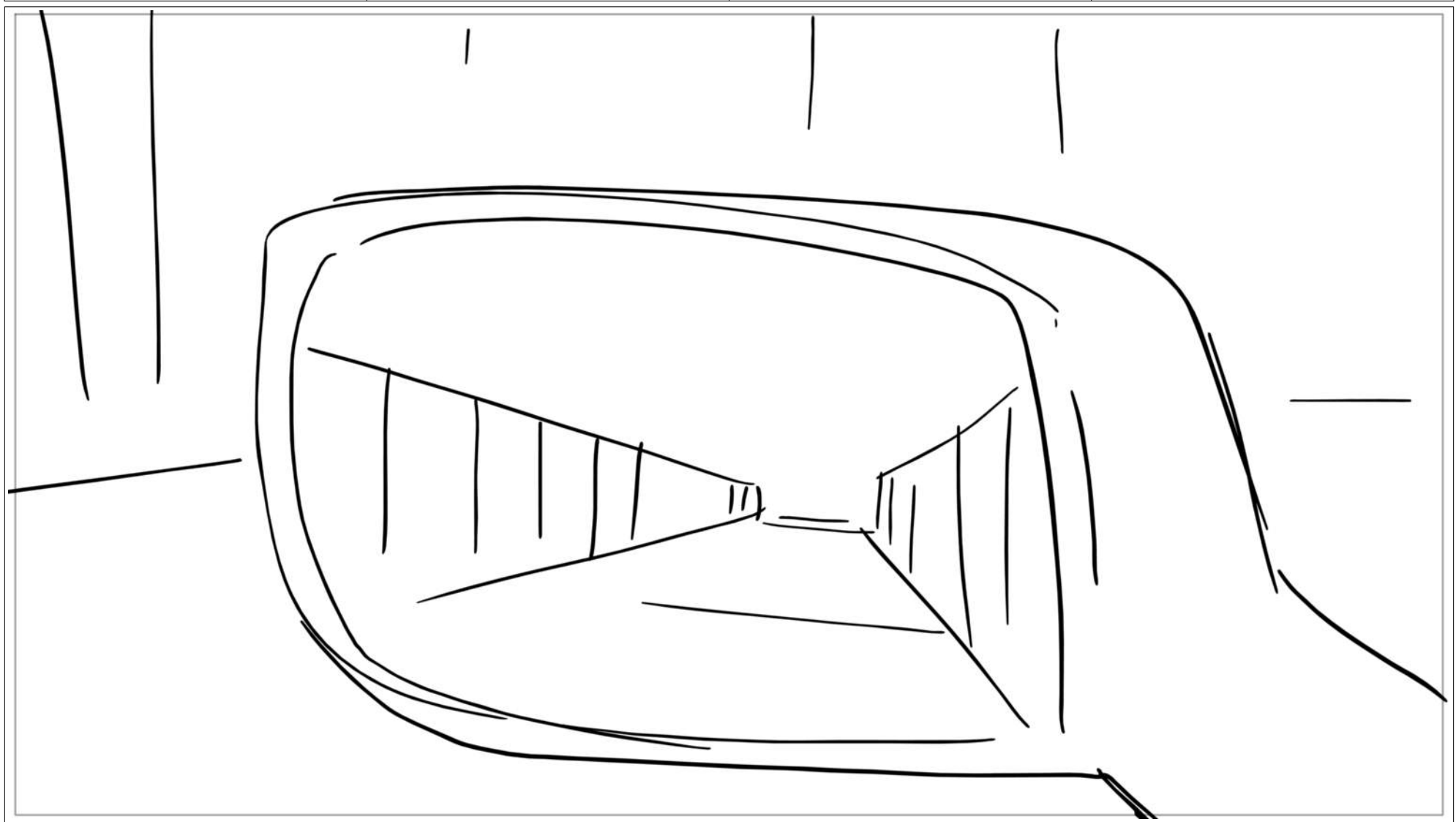

Scene	Duration	Panel	Duration
1	05:28:03	167	01:00

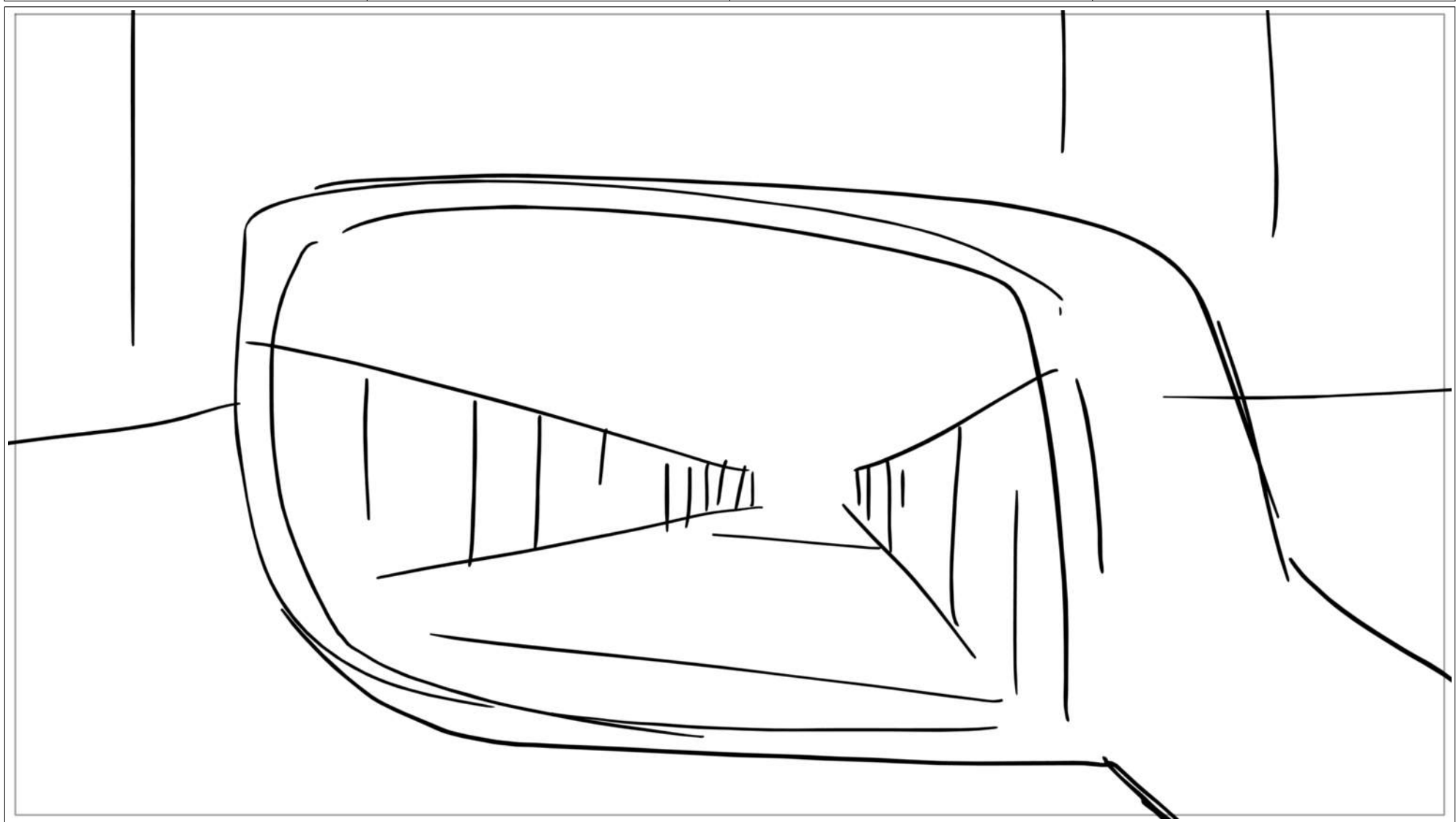

Scene	Duration	Panel	Duration
1	05:28:03	168	01:00

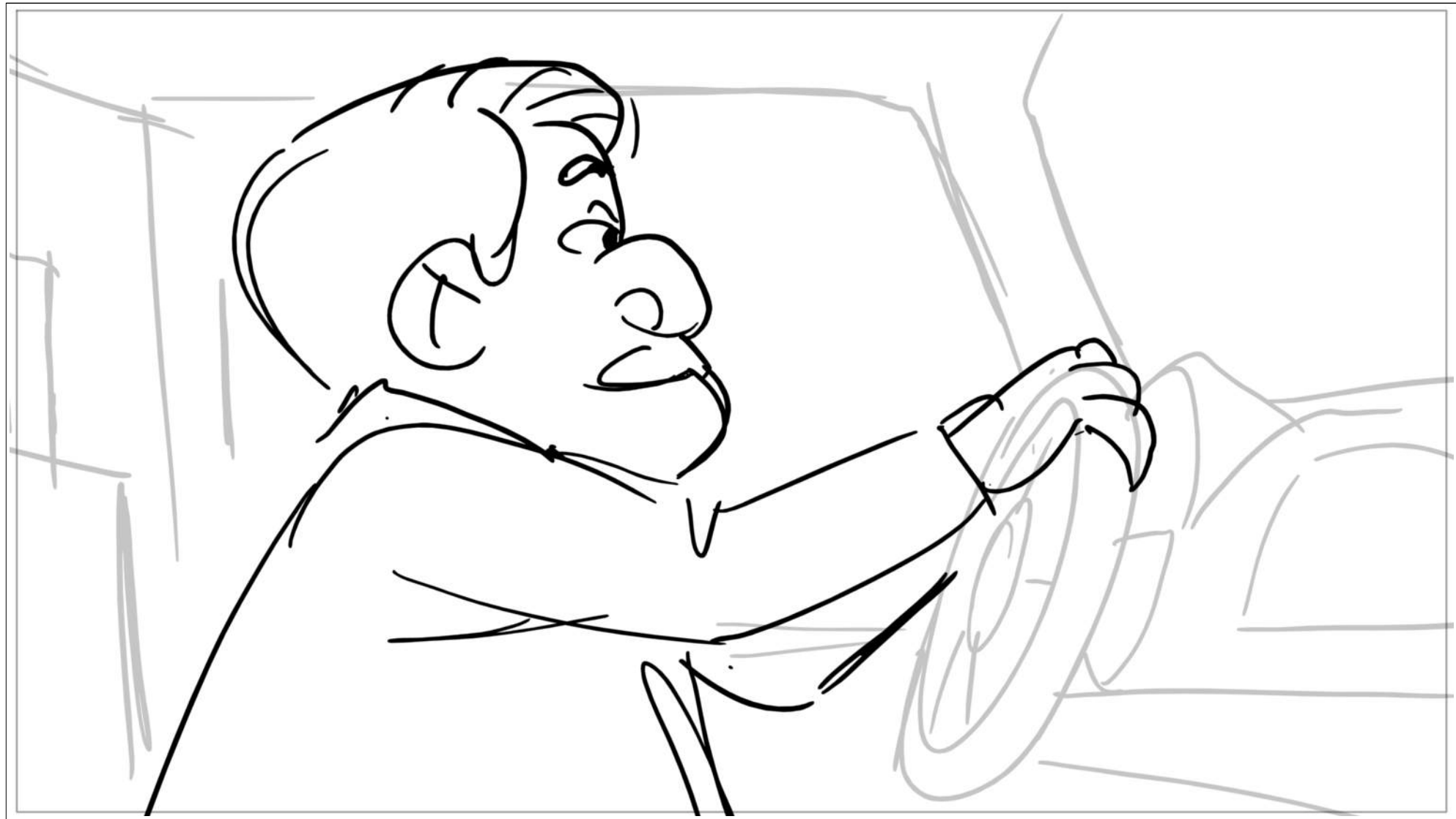

Scene	1	Duration	05:28:03	Panel	169	Duration	01:00
-------	---	----------	----------	-------	-----	----------	-------



Scene	Duration	Panel	Duration
1	05:28:03	170	01:00



Scene	Duration	Panel	Duration
1	05:28:03	171	01:00



Scene	1	Duration	05:28:03	Panel	172	Duration	01:00
-------	---	----------	----------	-------	-----	----------	-------



Scene	Duration	Panel	Duration
1	05:28:03	173	01:00



Scene	Duration	Panel	Duration
1	05:28:03	174	01:00

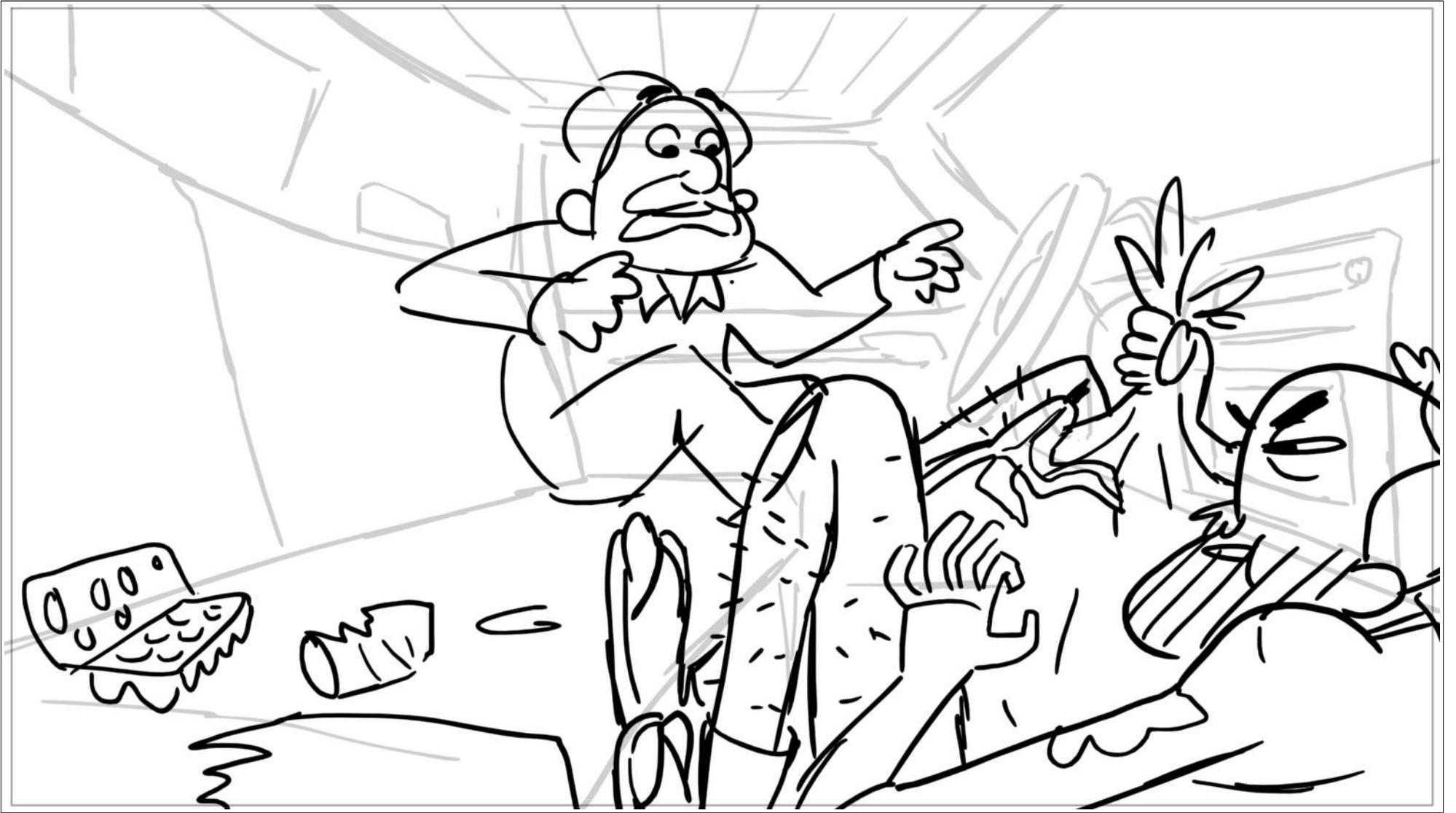

Scene	Duration	Panel	Duration
1	05:28:03	175	01:00

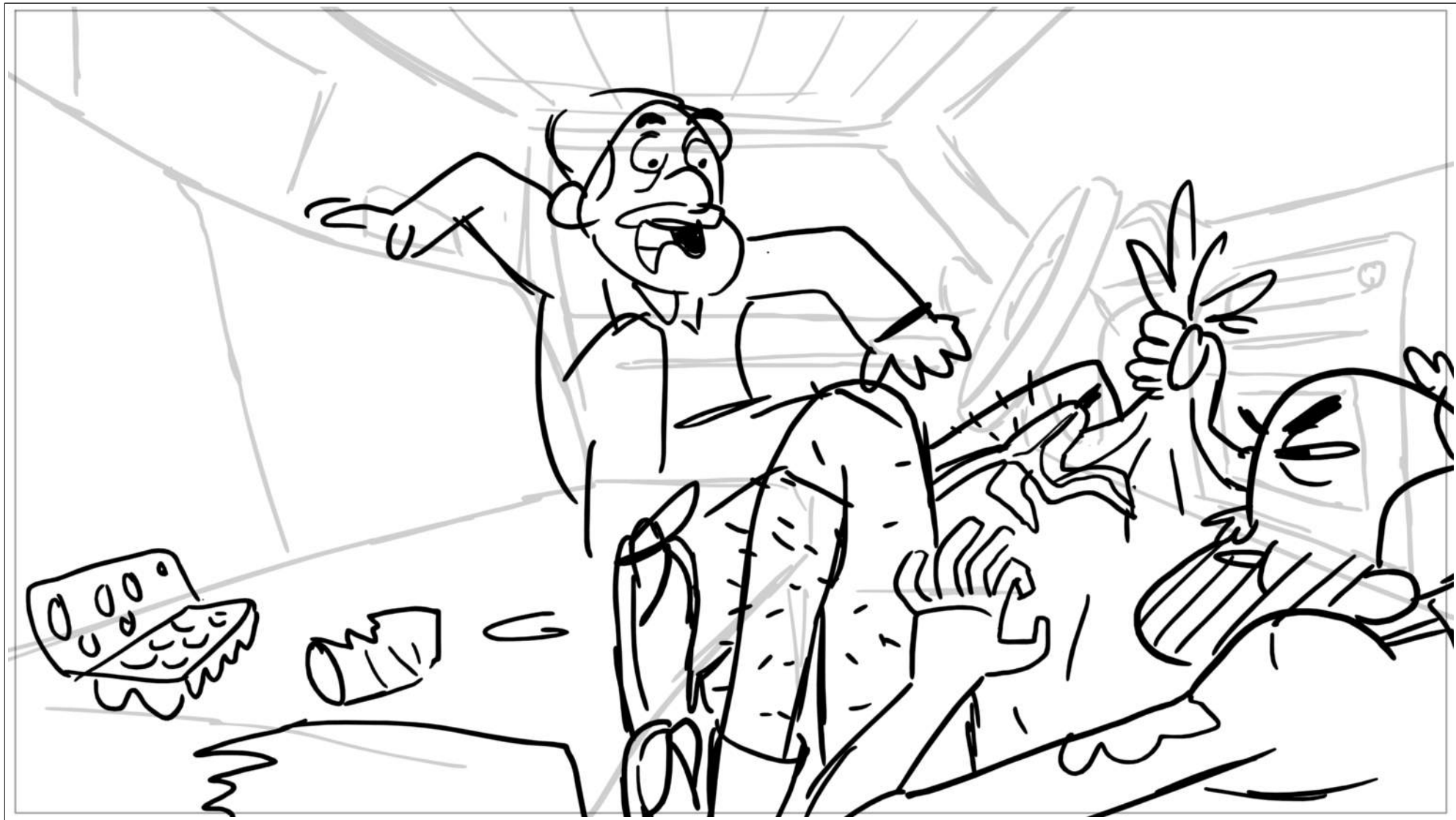

Scene	Duration	Panel	Duration
1	05:28:03	176	01:00



Scene	Duration	Panel	Duration
1	05:28:03	177	01:00



TAKE MY TRASH

Scene	Duration	Panel	Duration
1	05:28:03	178	01:00



TAKE MY TRASH

Scene	Duration	Panel	Duration
1	05:28:03	179	01:00



Scene	Duration	Panel	Duration
1	05:28:03	180	01:00



TAKE MY TRASH

Scene	Duration	Panel	Duration
1	05:28:03	181	01:00

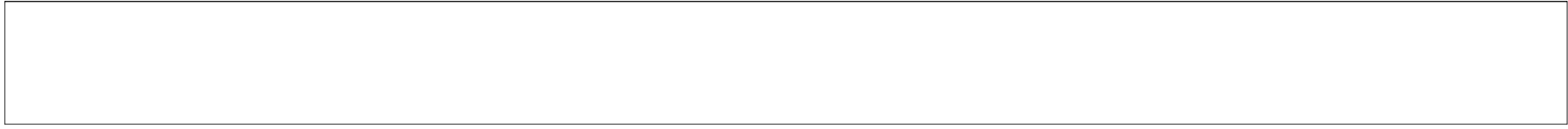

Scene	Duration	Panel	Duration
1	05:28:03	182	01:00



Scene	Duration	Panel	Duration
1	05:28:03	183	01:00



Scene	Duration	Panel	Duration
1	05:28:03	184	01:00



Scene	Duration	Panel	Duration
1	05:28:03	185	01:00



Scene	Duration	Panel	Duration
1	05:28:03	186	01:00



Scene	Duration	Panel	Duration
1	05:28:03	187	01:00

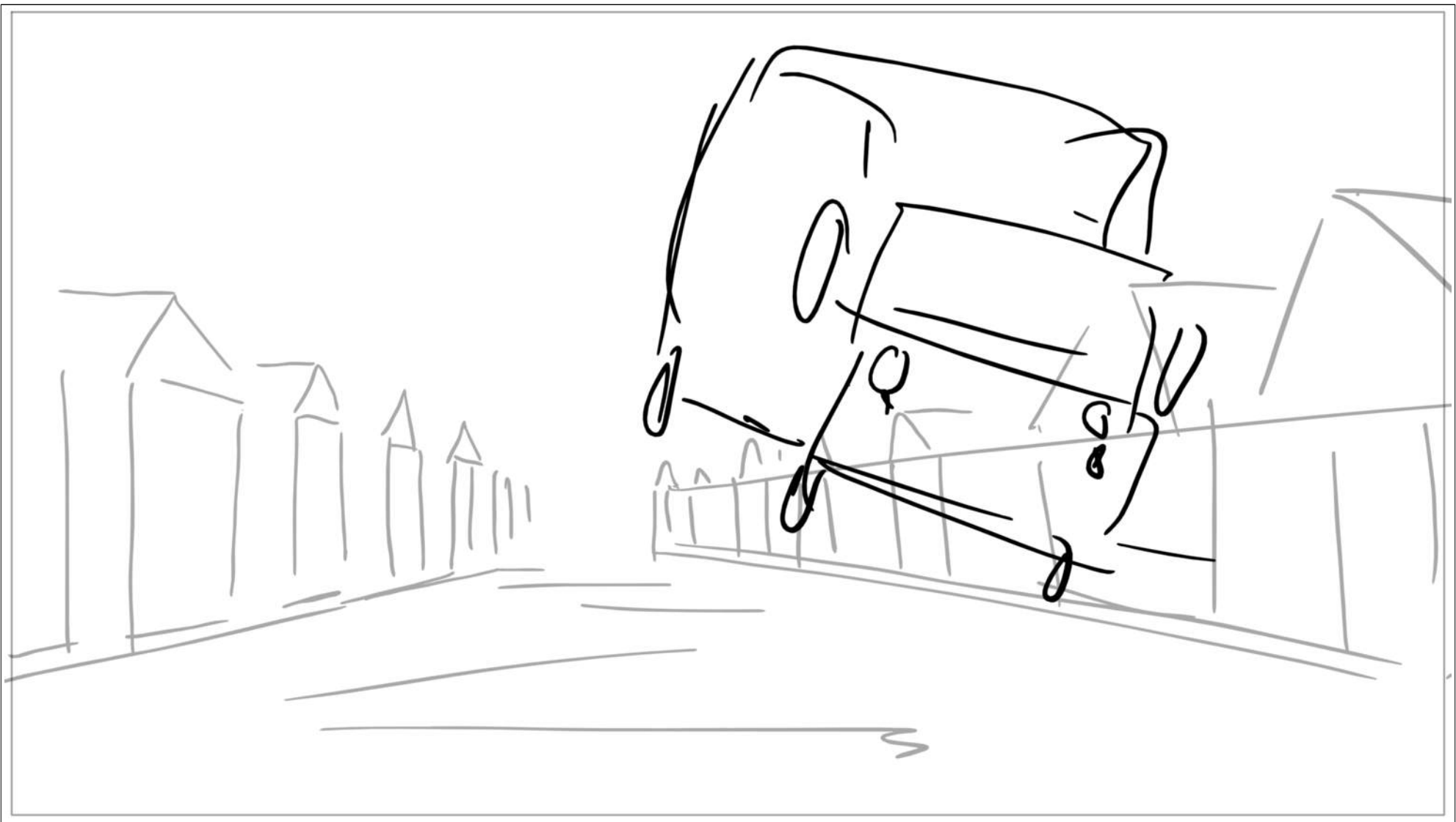

Scene	Duration	Panel	Duration
1	05:28:03	188	01:00



Scene	Duration	Panel	Duration
1	05:28:03	189	01:00

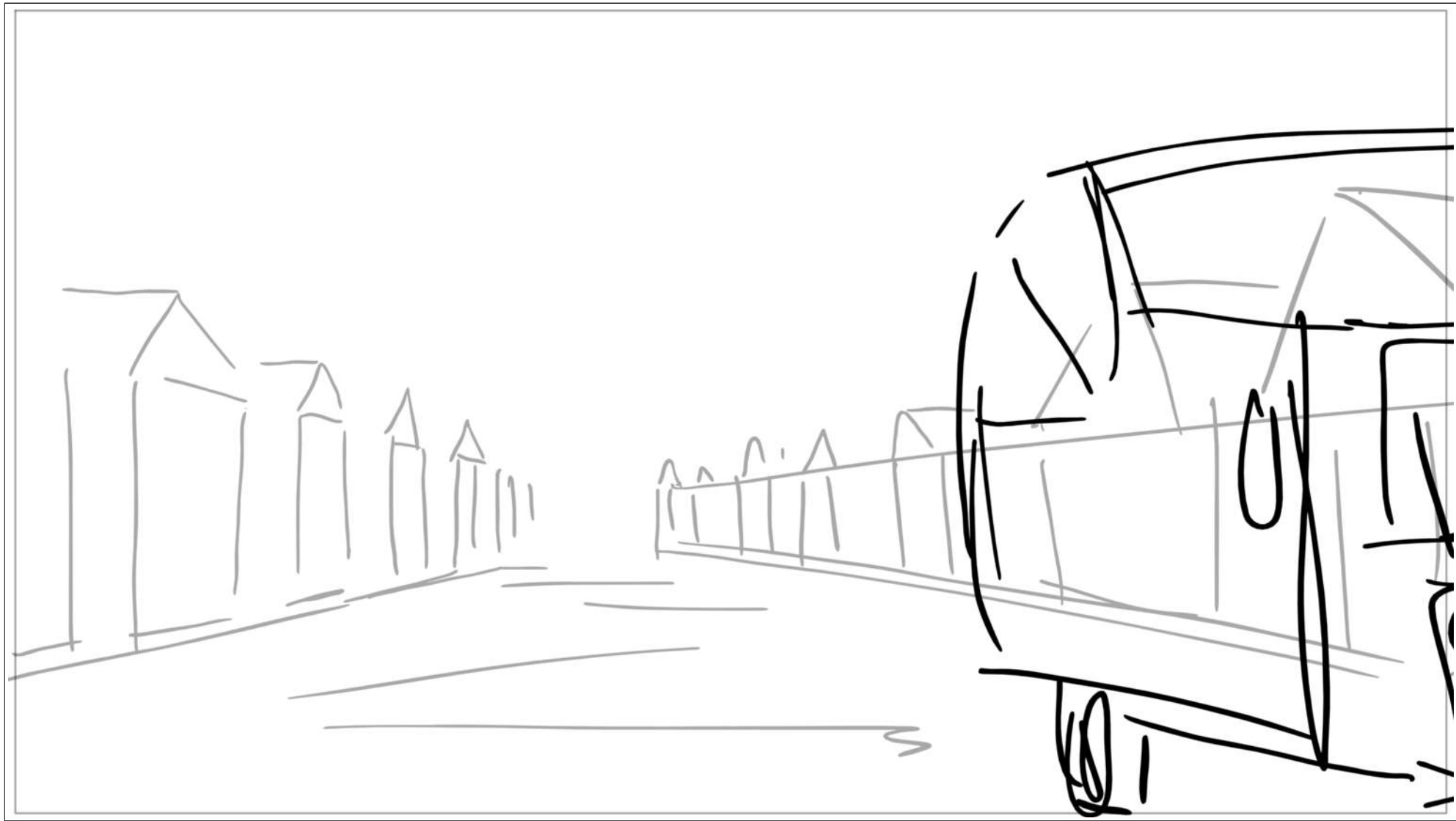

Scene	Duration	Panel	Duration
1	05:28:03	190	01:00

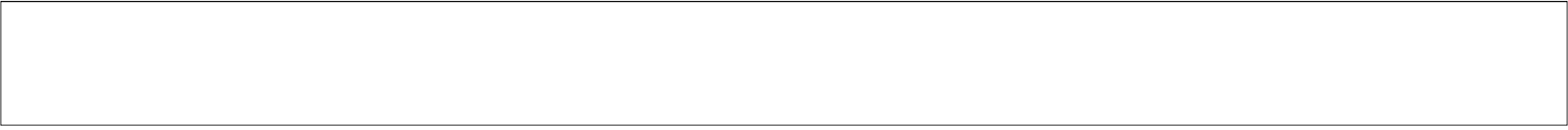

Scene	Duration	Panel	Duration
1	05:28:03	191	01:00



Scene	Duration	Panel	Duration
1	05:28:03	192	01:00

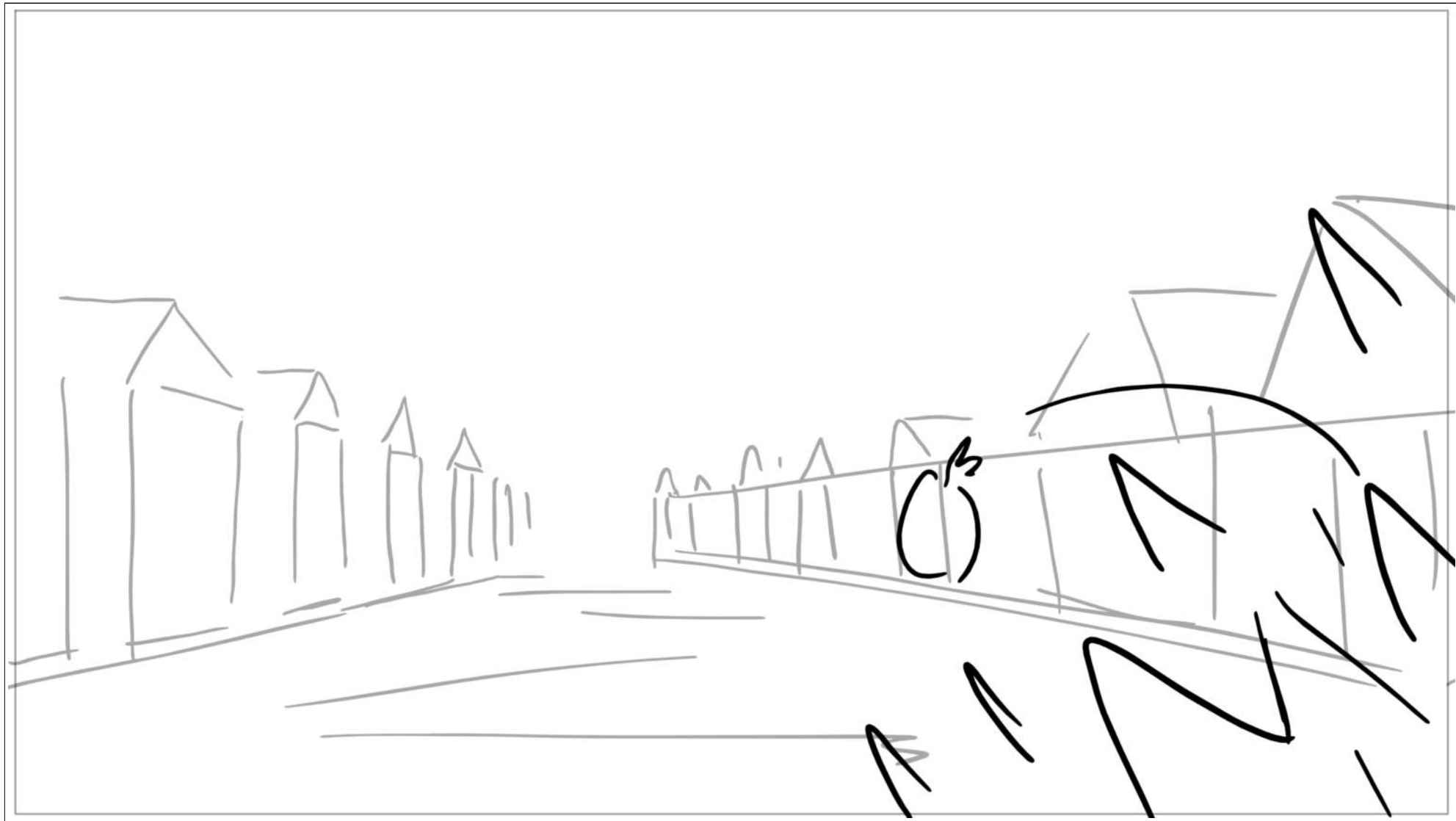

Scene	Duration	Panel	Duration
1	05:28:03	193	01:00



Scene	Duration	Panel	Duration
1	05:28:03	194	01:00



Scene	1	Duration	05:28:03	Panel	195	Duration	01:00
-------	---	----------	----------	-------	-----	----------	-------

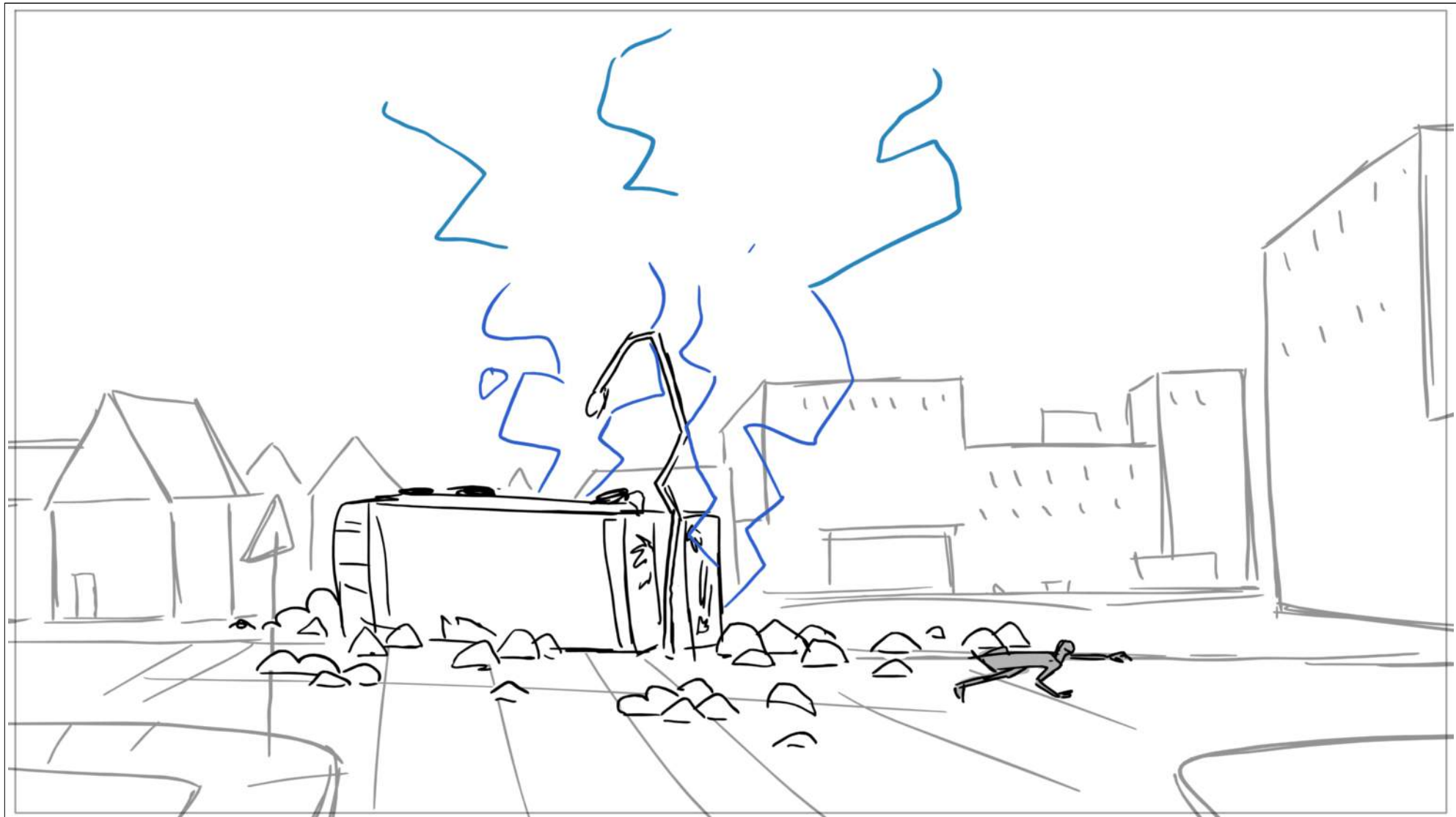

Scene	1	Duration	05:28:03	Panel	196	Duration	01:00
-------	---	----------	----------	-------	-----	----------	-------

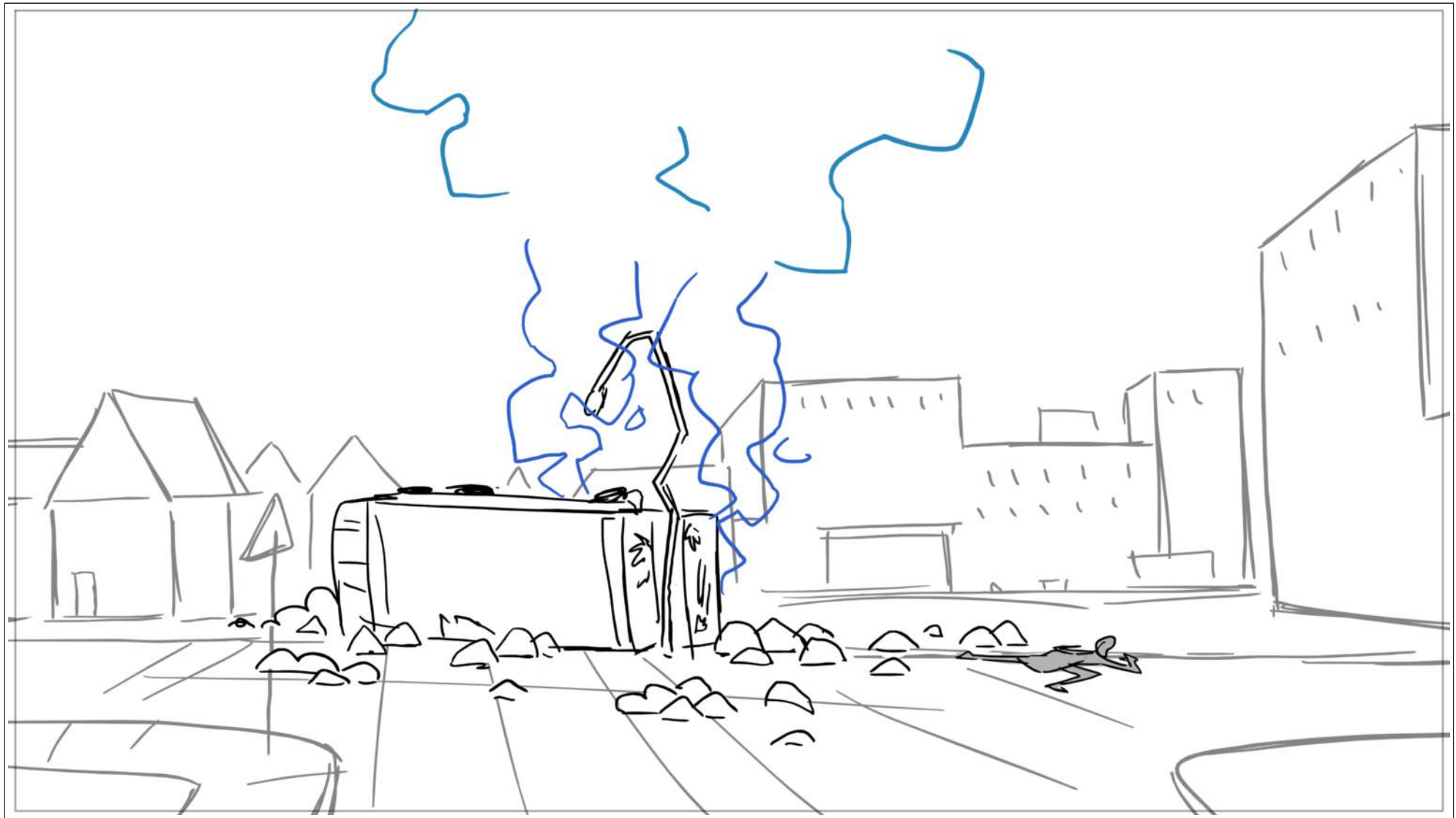

Scene	1	Duration	05:28:03	Panel	197	Duration	01:00
-------	---	----------	----------	-------	-----	----------	-------

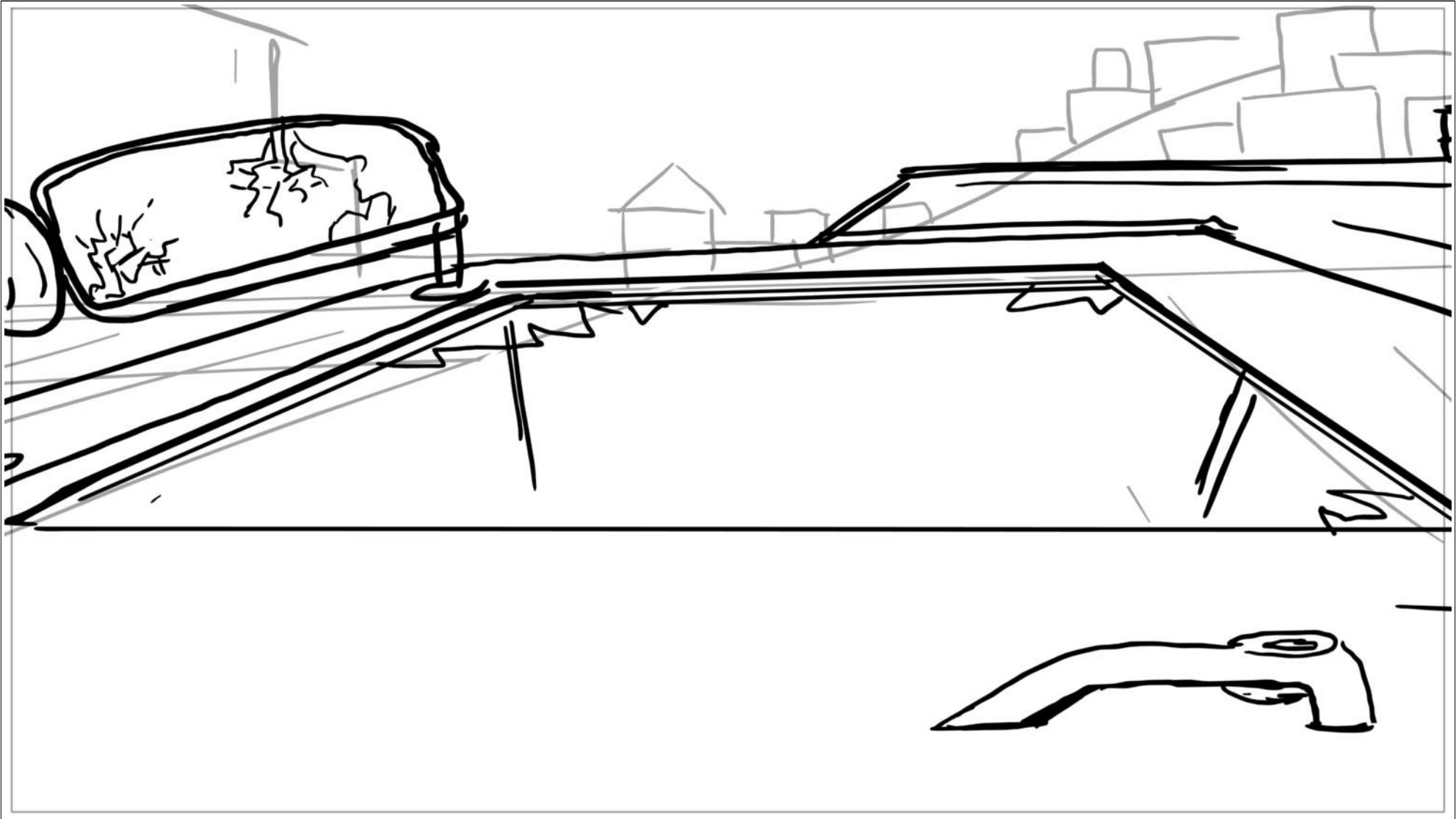

Scene	Duration	Panel	Duration
1	05:28:03	198	01:00

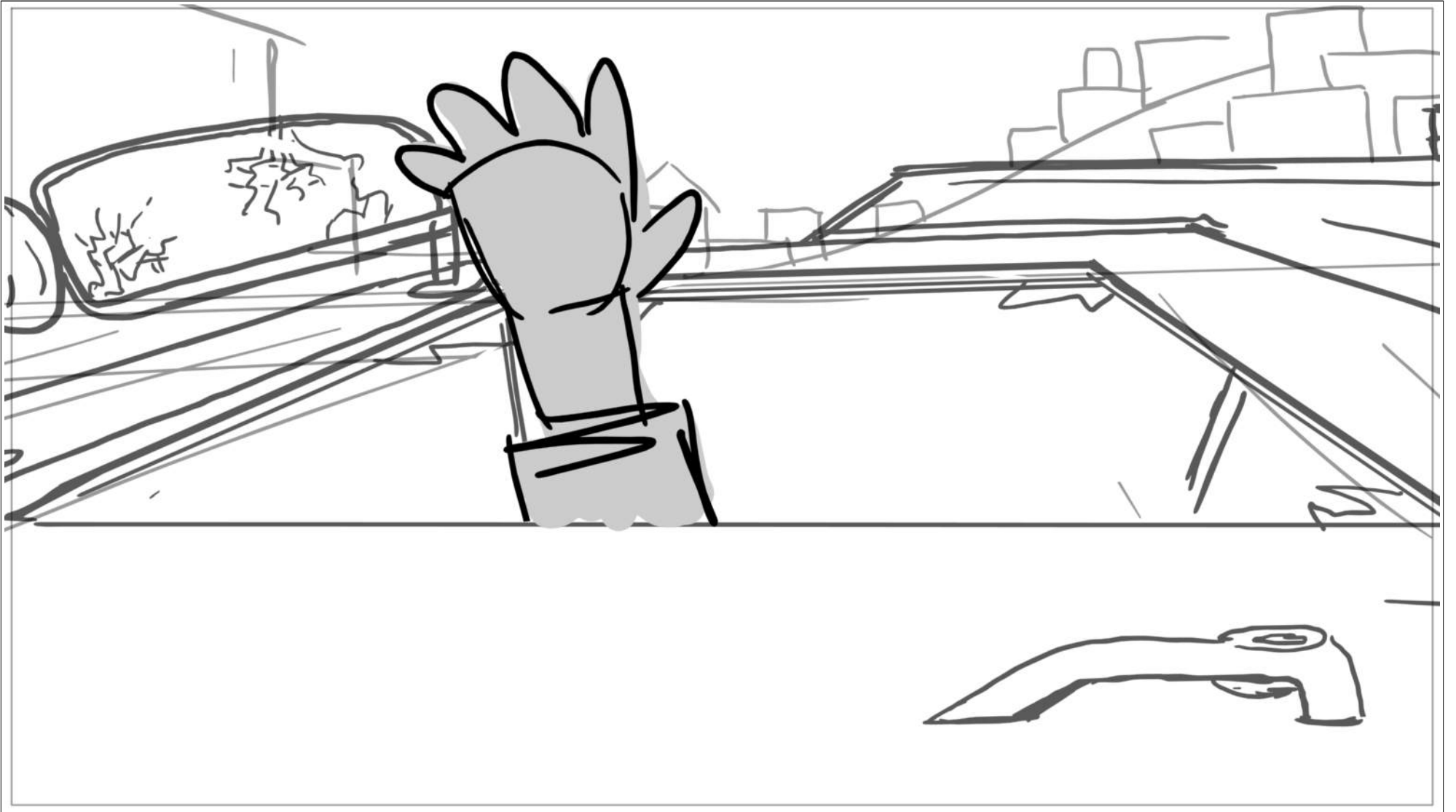

Scene	Duration	Panel	Duration
1	05:28:03	199	01:00

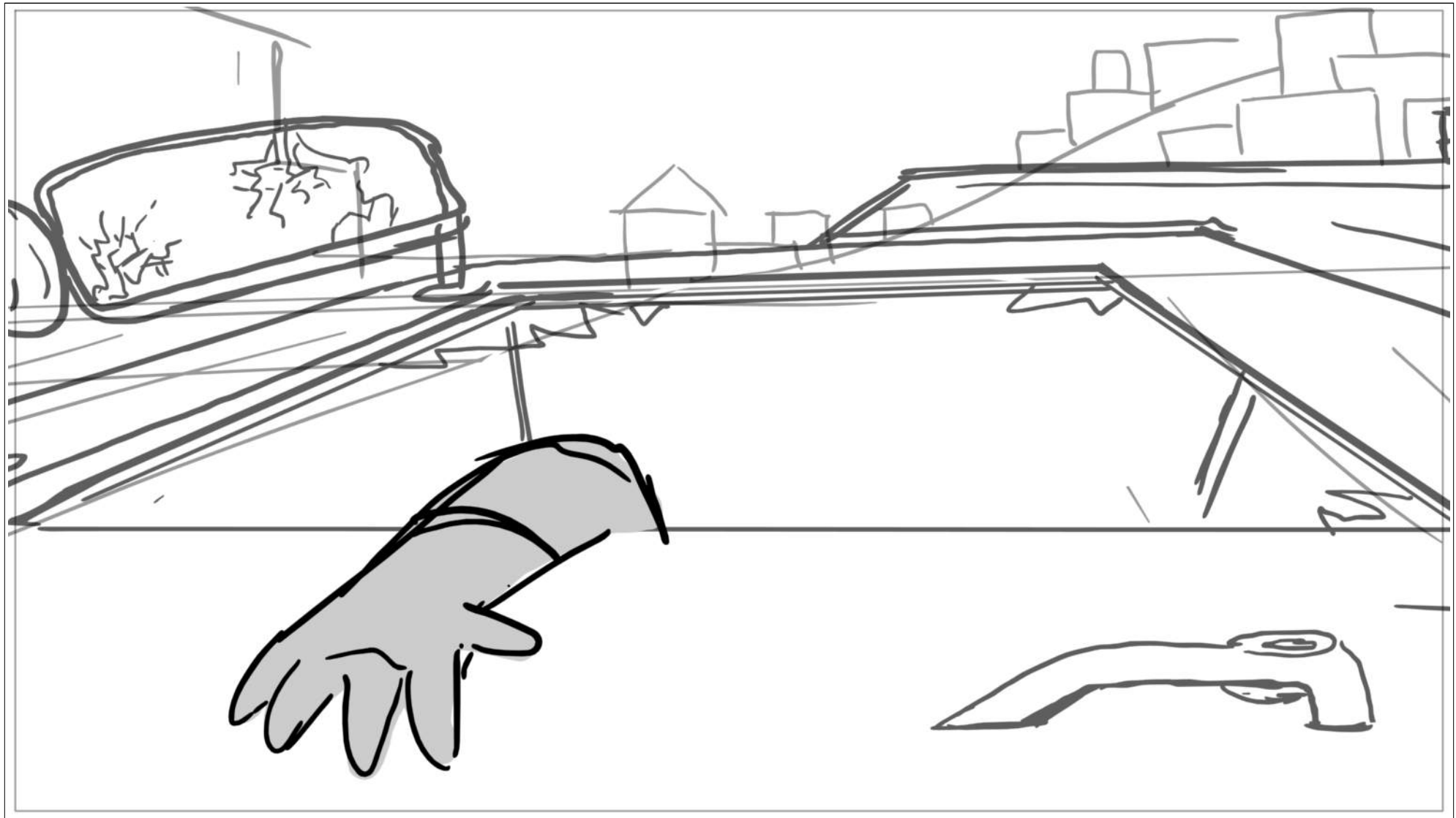

Scene	1	Duration	05:28:03	Panel	200	Duration	01:00
-------	---	----------	----------	-------	-----	----------	-------

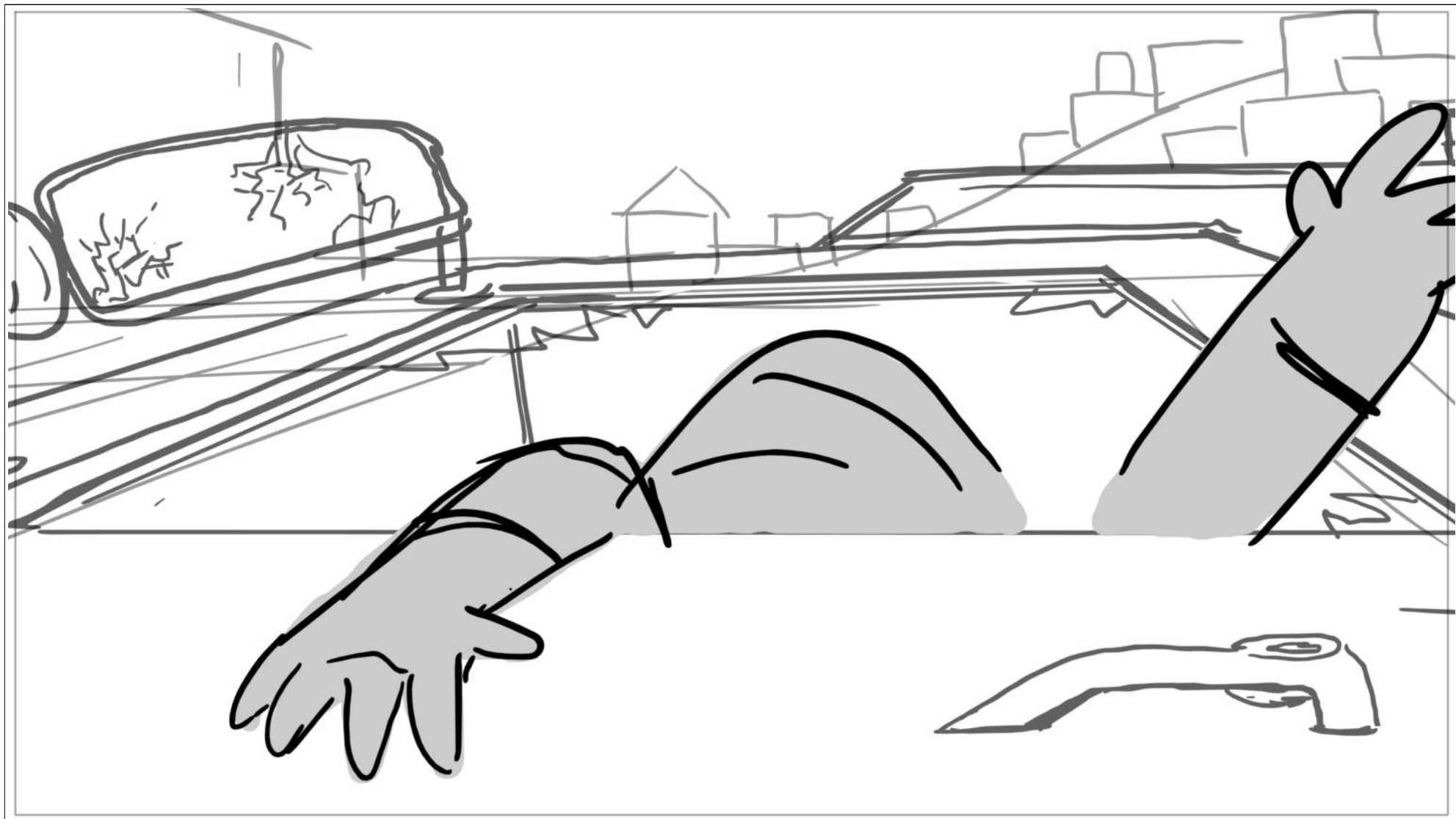

Scene	1	Duration	05:28:03	Panel	201	Duration	01:00
-------	---	----------	----------	-------	-----	----------	-------



Scene	Duration	Panel	Duration
1	05:28:03	202	01:00



Scene	1	Duration	05:28:03	Panel	203	Duration	01:00
-------	---	----------	----------	-------	-----	----------	-------



Scene	Duration	Panel	Duration
1	05:28:03	204	01:00

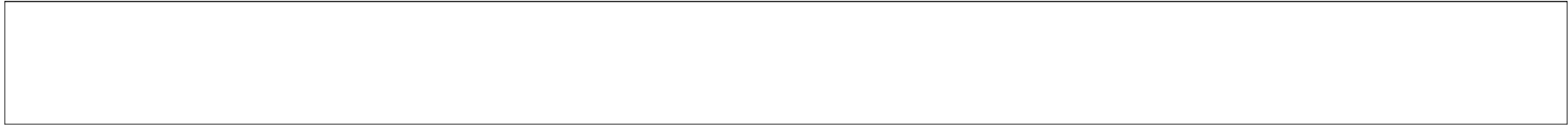

Scene	Duration	Panel	Duration
1	05:28:03	205	01:00

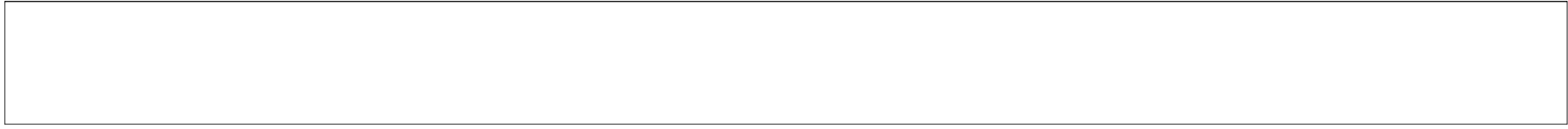

Scene	1	Duration	05:28:03	Panel	206	Duration	01:00
-------	---	----------	----------	-------	-----	----------	-------



Scene	Duration	Panel	Duration
1	05:28:03	207	01:00



Scene	Duration	Panel	Duration
1	05:28:03	208	01:00



Scene	Duration	Panel	Duration
1	05:28:03	209	01:00



Scene	1	Duration	05:28:03	Panel	210	Duration	01:00
-------	---	----------	----------	-------	-----	----------	-------



Scene	1	Duration	05:28:03	Panel	211	Duration	01:00
-------	---	----------	----------	-------	-----	----------	-------



Scene	Duration	Panel	Duration
1	05:28:03	212	01:00



Scene	Duration	Panel	Duration
1	05:28:03	213	01:00



Scene	1	Duration	05:28:03	Panel	214	Duration	01:00
-------	---	----------	----------	-------	-----	----------	-------



Scene	Duration	Panel	Duration
1	05:28:03	215	01:00



Scene	Duration	Panel	Duration
1	05:28:03	216	01:00



Scene	1	Duration	05:28:03	Panel	217	Duration	01:00
-------	---	----------	----------	-------	-----	----------	-------

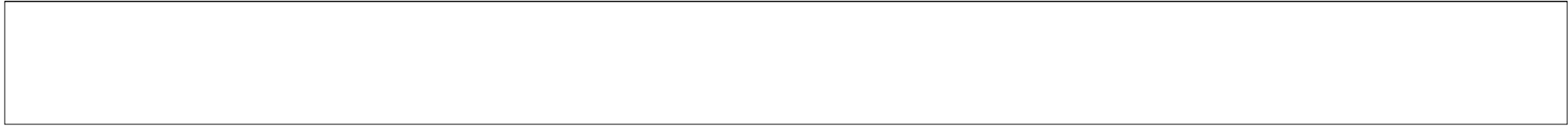

Scene	Duration	Panel	Duration
1	05:28:03	218	01:00



Scene	Duration	Panel	Duration
1	05:28:03	219	01:00

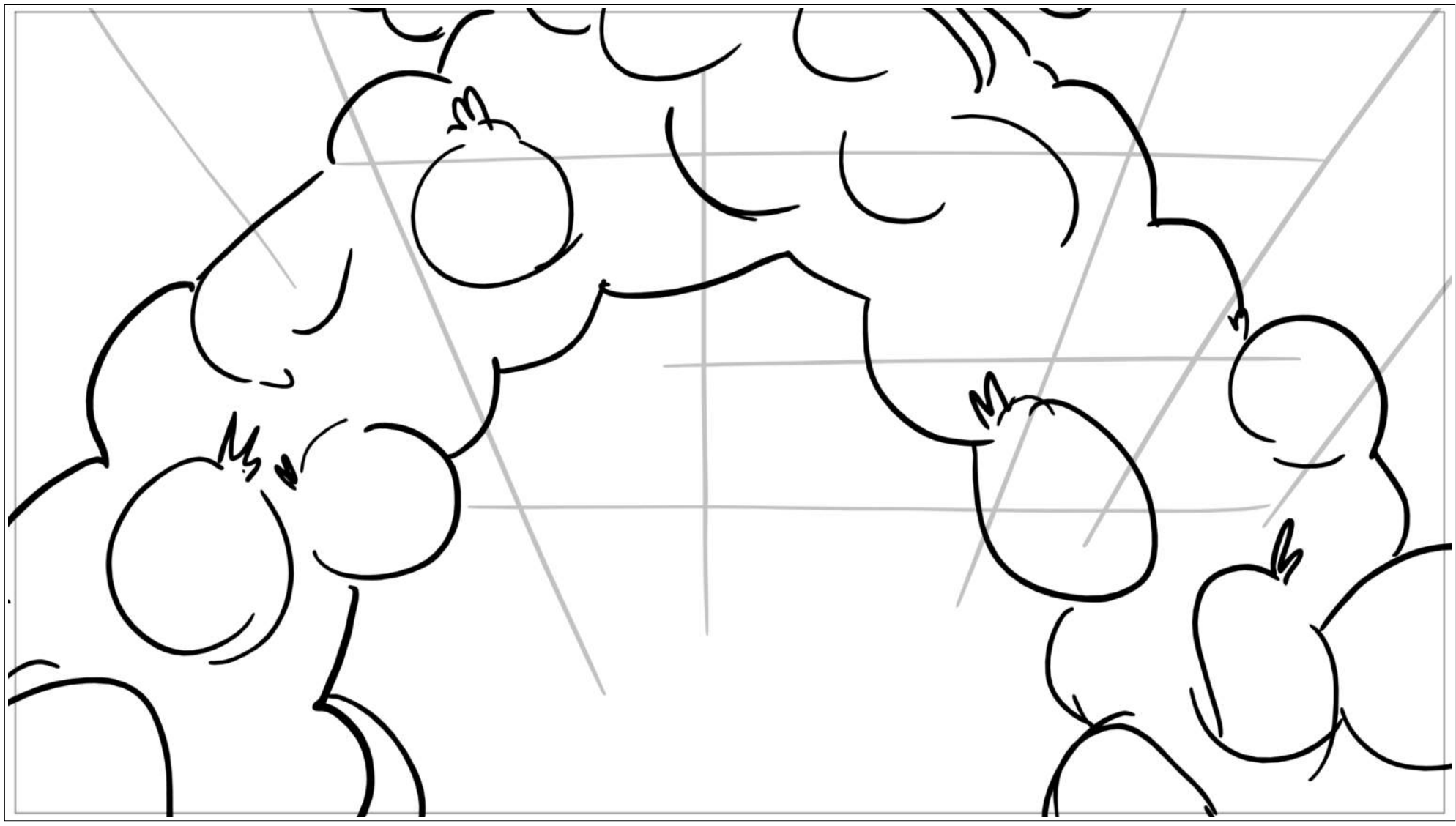

Scene	1	Duration	05:28:03	Panel	220	Duration	01:00
-------	---	----------	----------	-------	-----	----------	-------

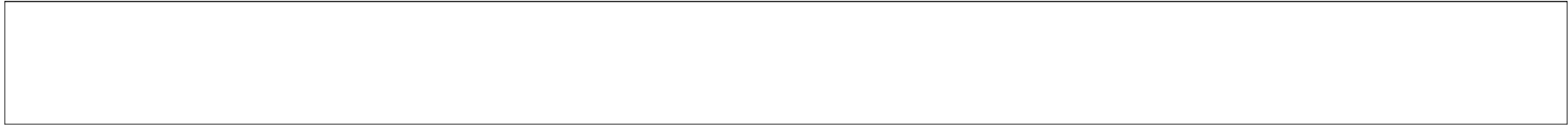
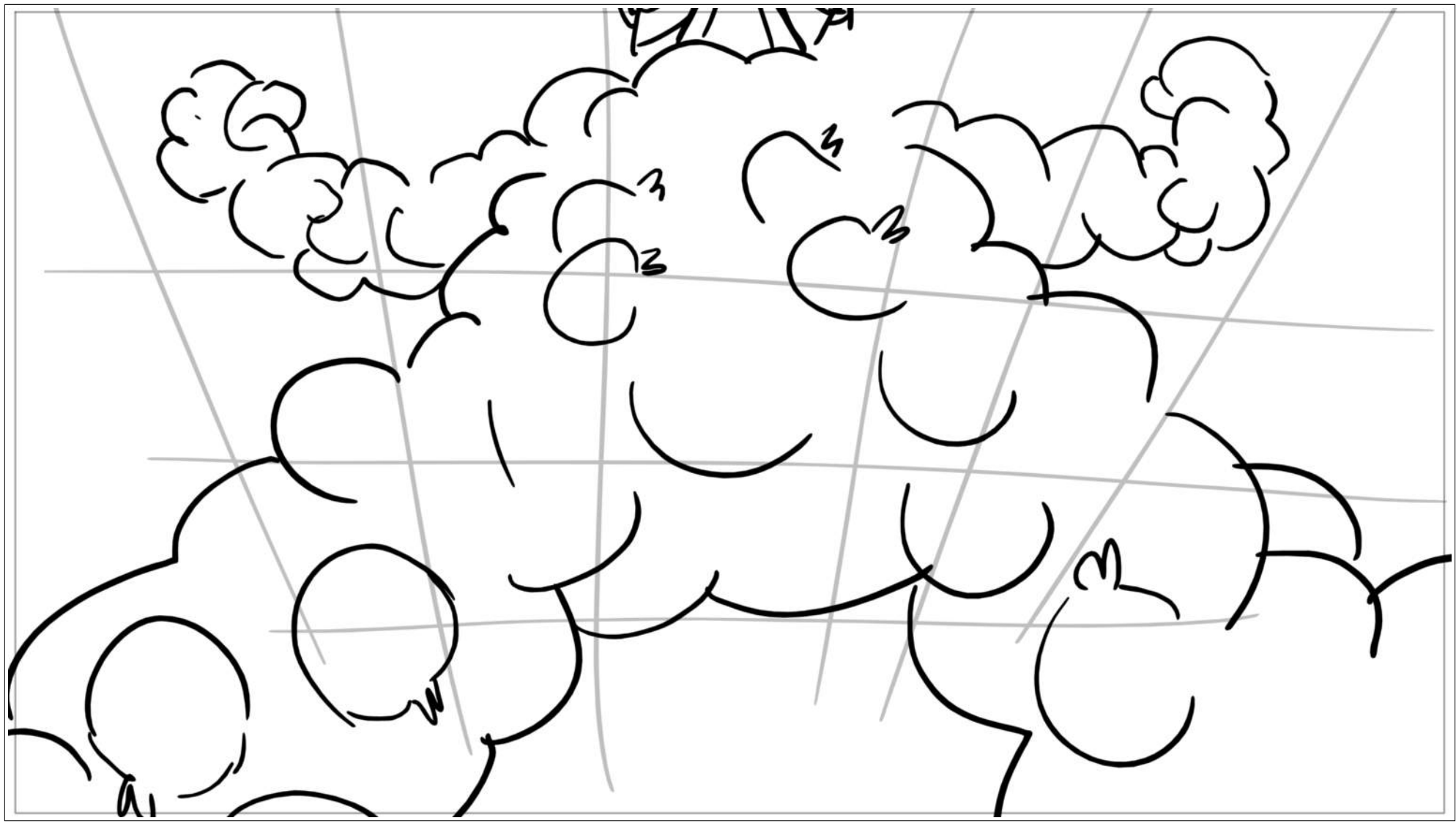

Scene	1	Duration	05:28:03	Panel	221	Duration	01:00
-------	---	----------	----------	-------	-----	----------	-------

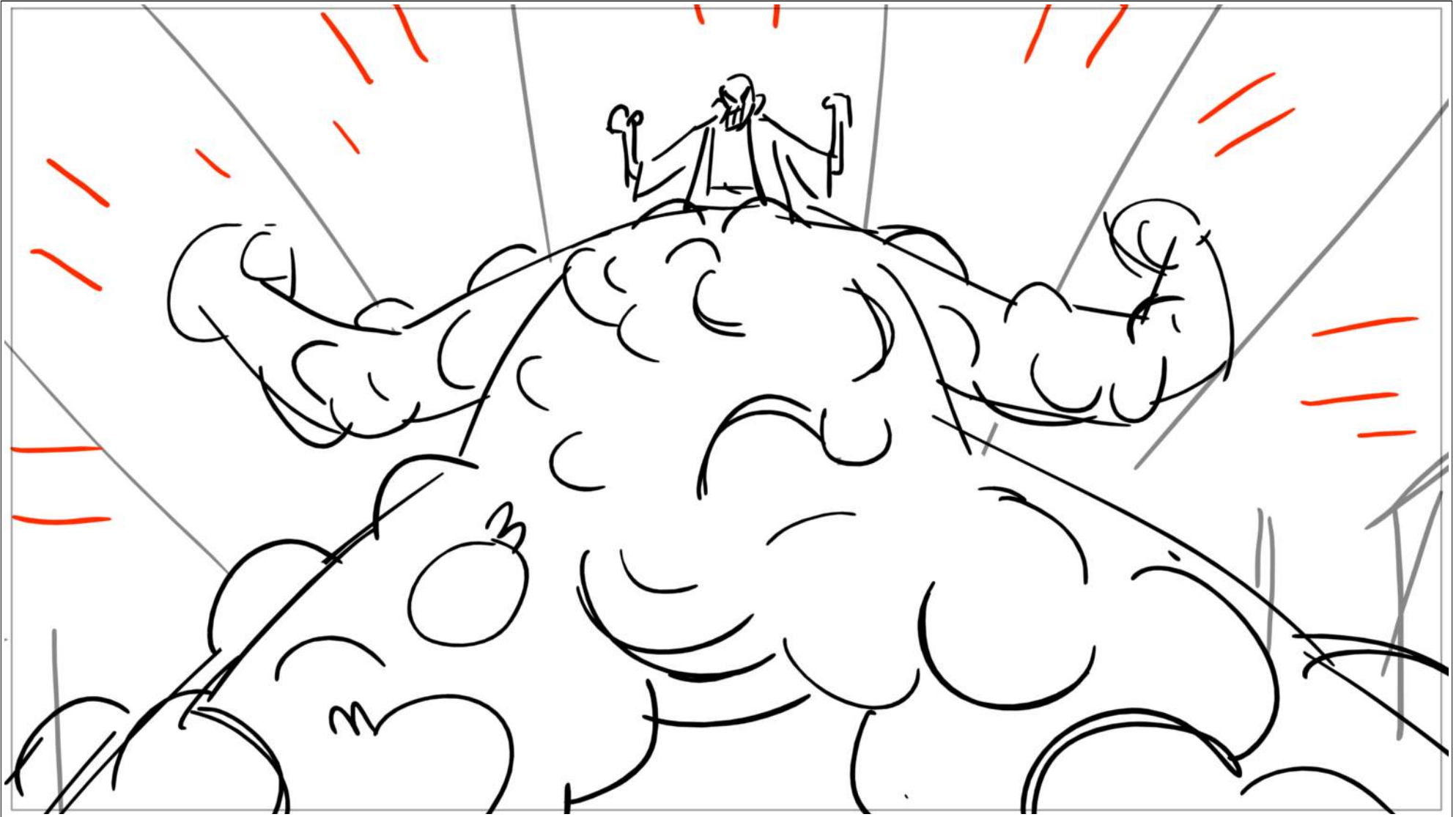

Scene	1	Duration	05:28:03	Panel	222	Duration	01:00
-------	---	----------	----------	-------	-----	----------	-------



Scene	1	Duration	05:28:03	Panel	223	Duration	01:00
-------	---	----------	----------	-------	-----	----------	-------



Scene	1	Duration	05:28:03	Panel	224	Duration	01:00
-------	---	----------	----------	-------	-----	----------	-------

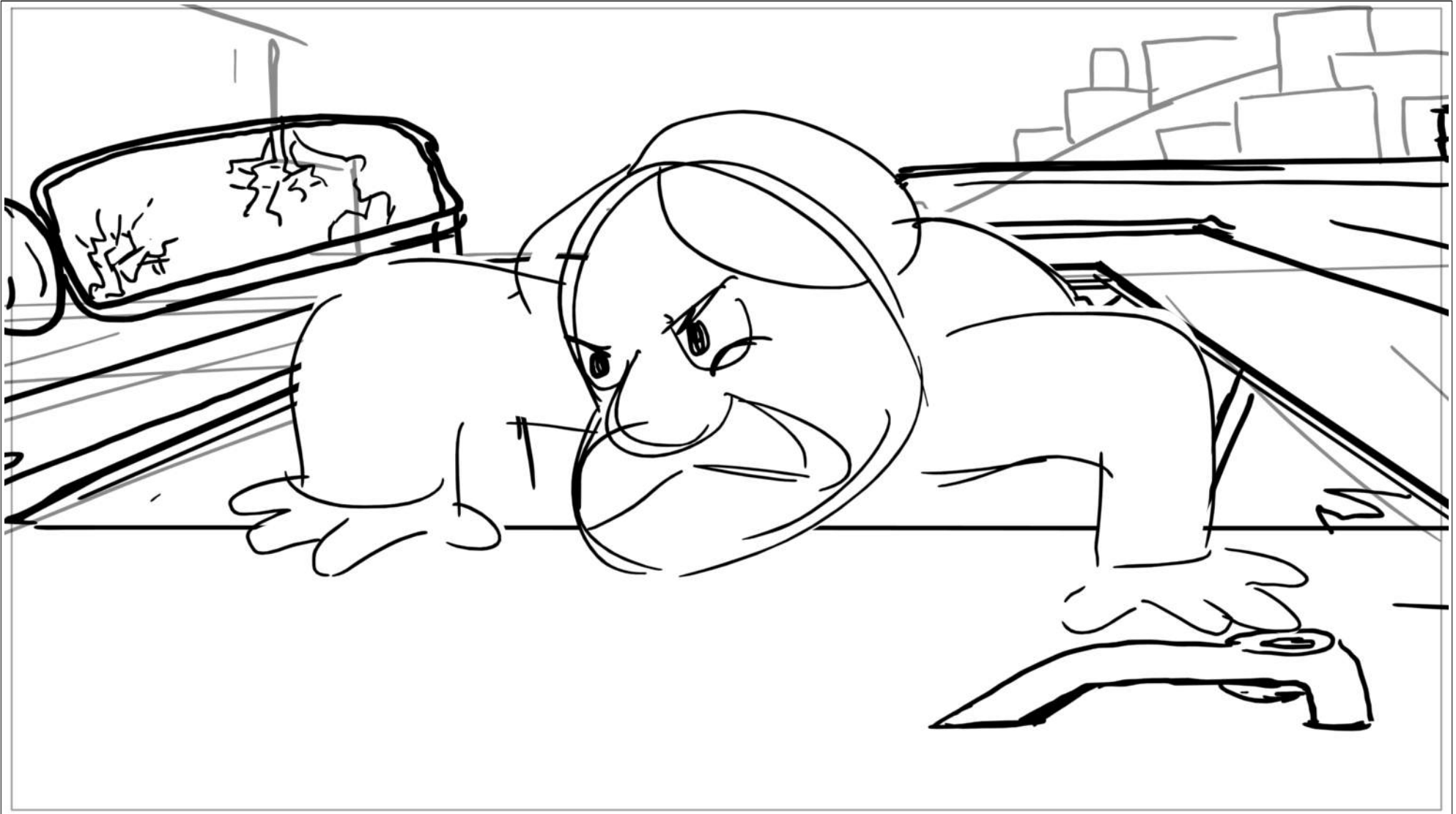

Scene	Duration	Panel	Duration
1	05:28:03	225	01:00

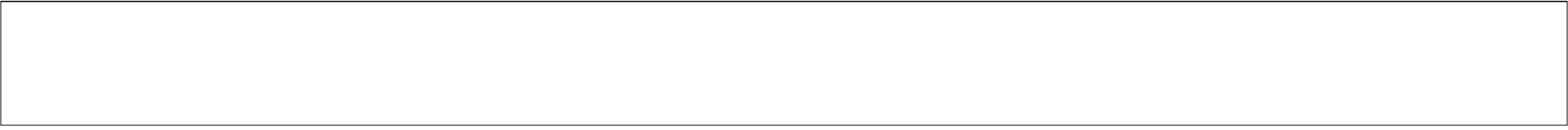

Scene	Duration	Panel	Duration
1	05:28:03	226	01:00



Scene	Duration	Panel	Duration
1	05:28:03	227	01:00



Scene	Duration	Panel	Duration
1	05:28:03	228	01:00

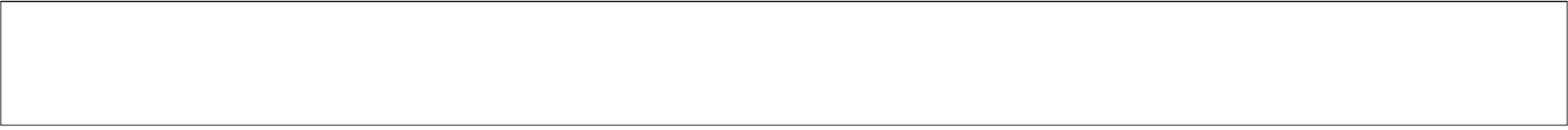

Scene	Duration	Panel	Duration
1	05:28:03	229	01:00

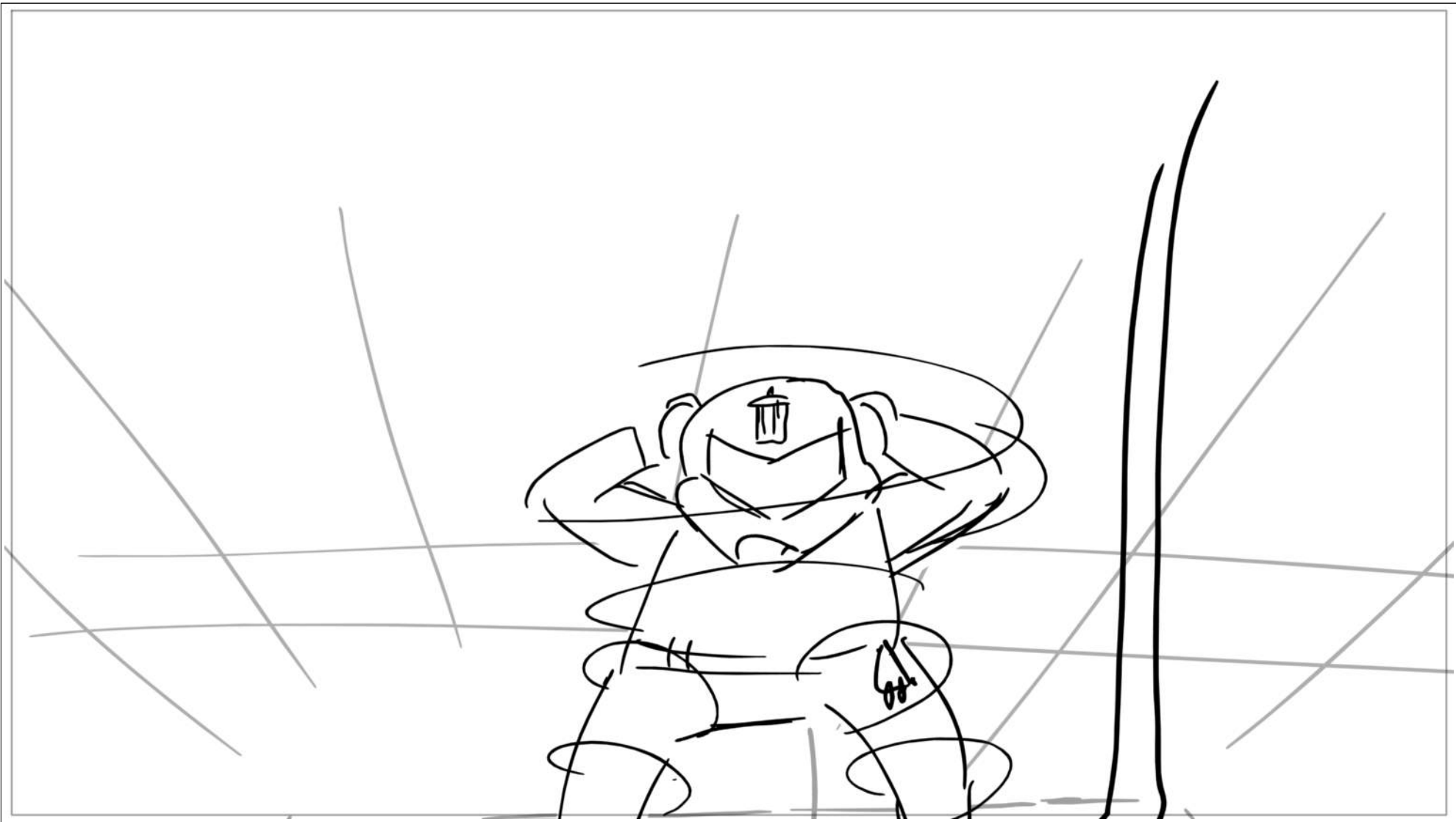

Scene	Duration	Panel	Duration
1	05:28:03	230	01:00

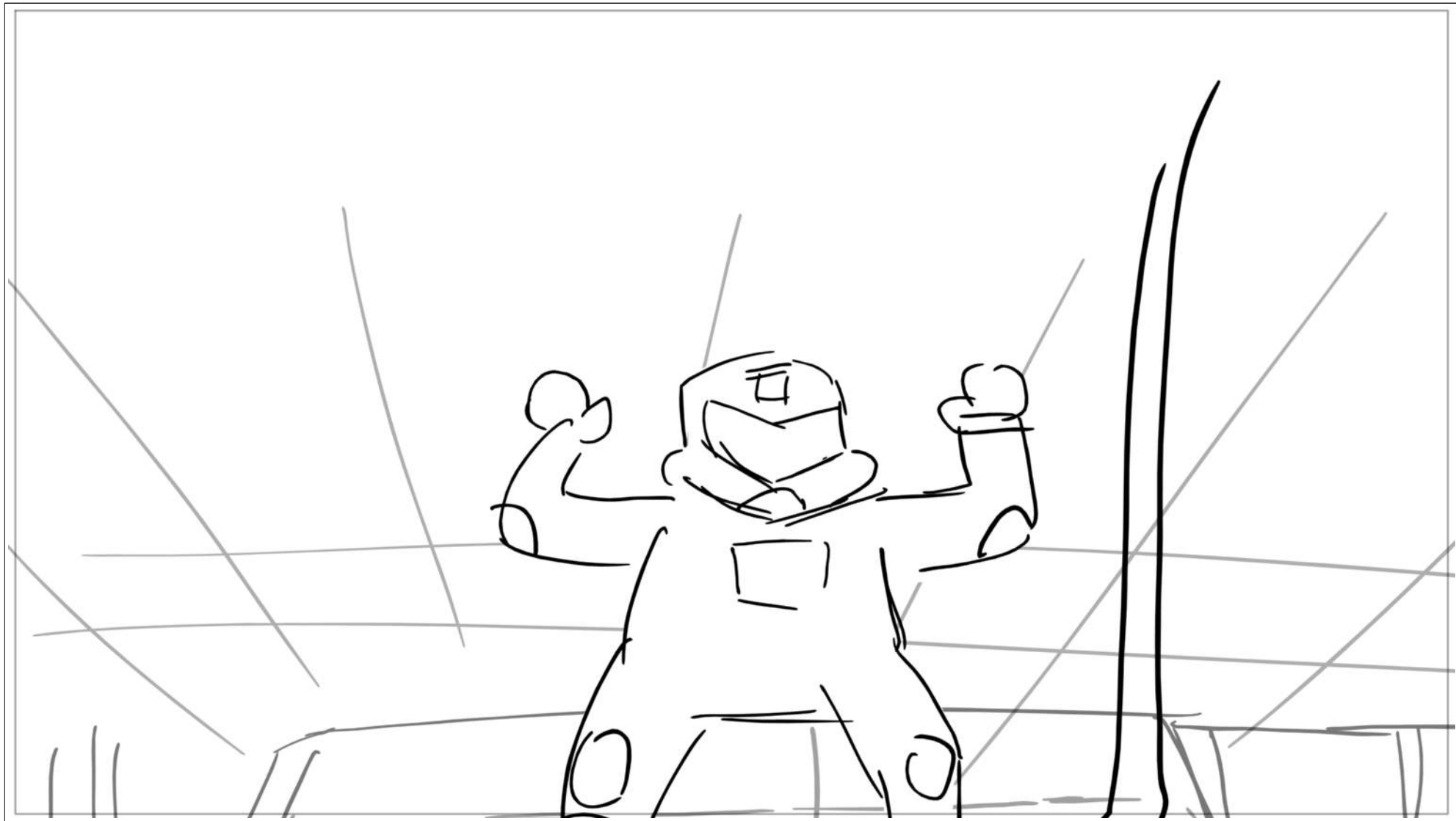

Scene	Duration	Panel	Duration
1	05:28:03	231	01:00

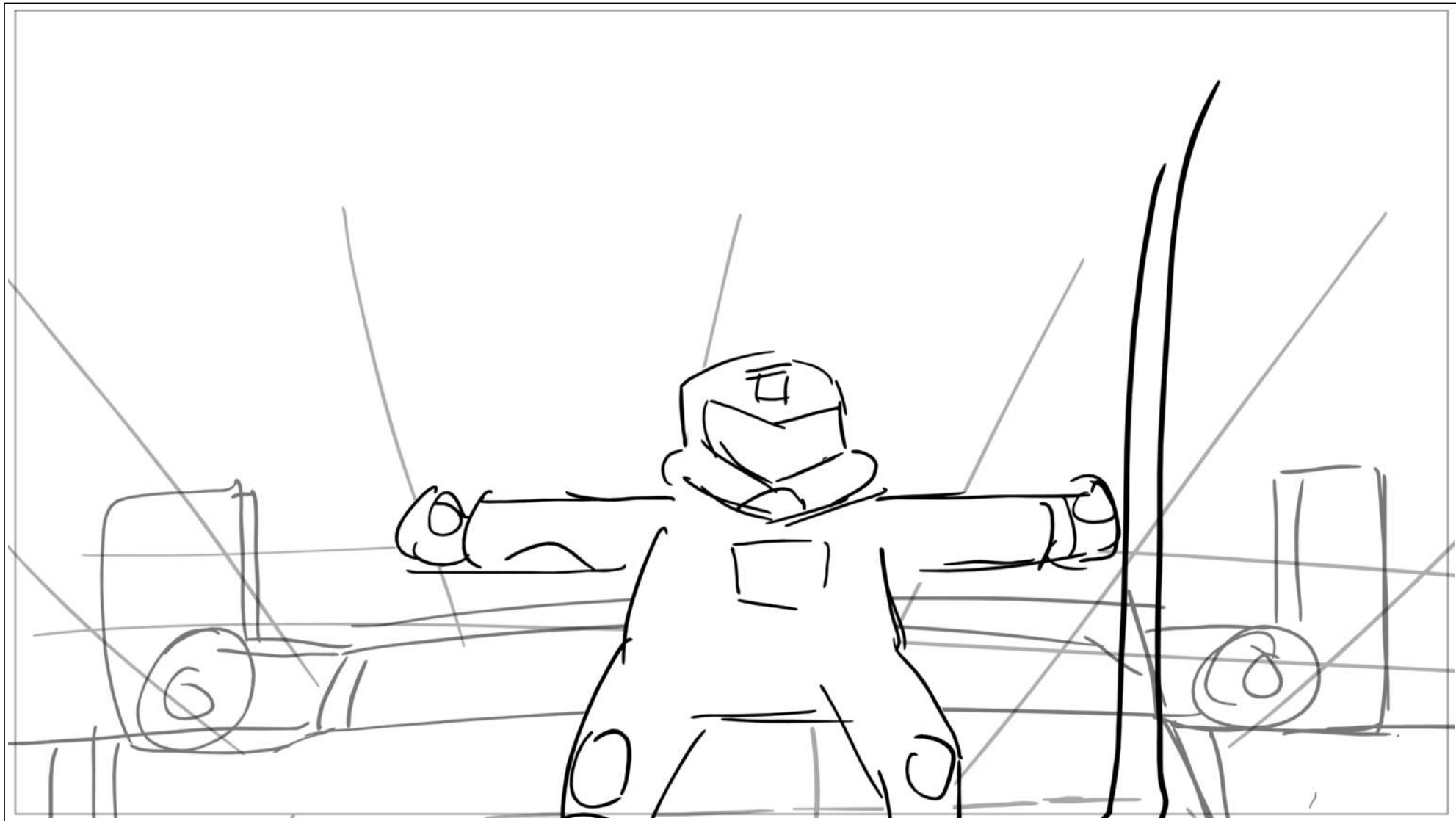

Scene	Duration	Panel	Duration
1	05:28:03	232	01:00

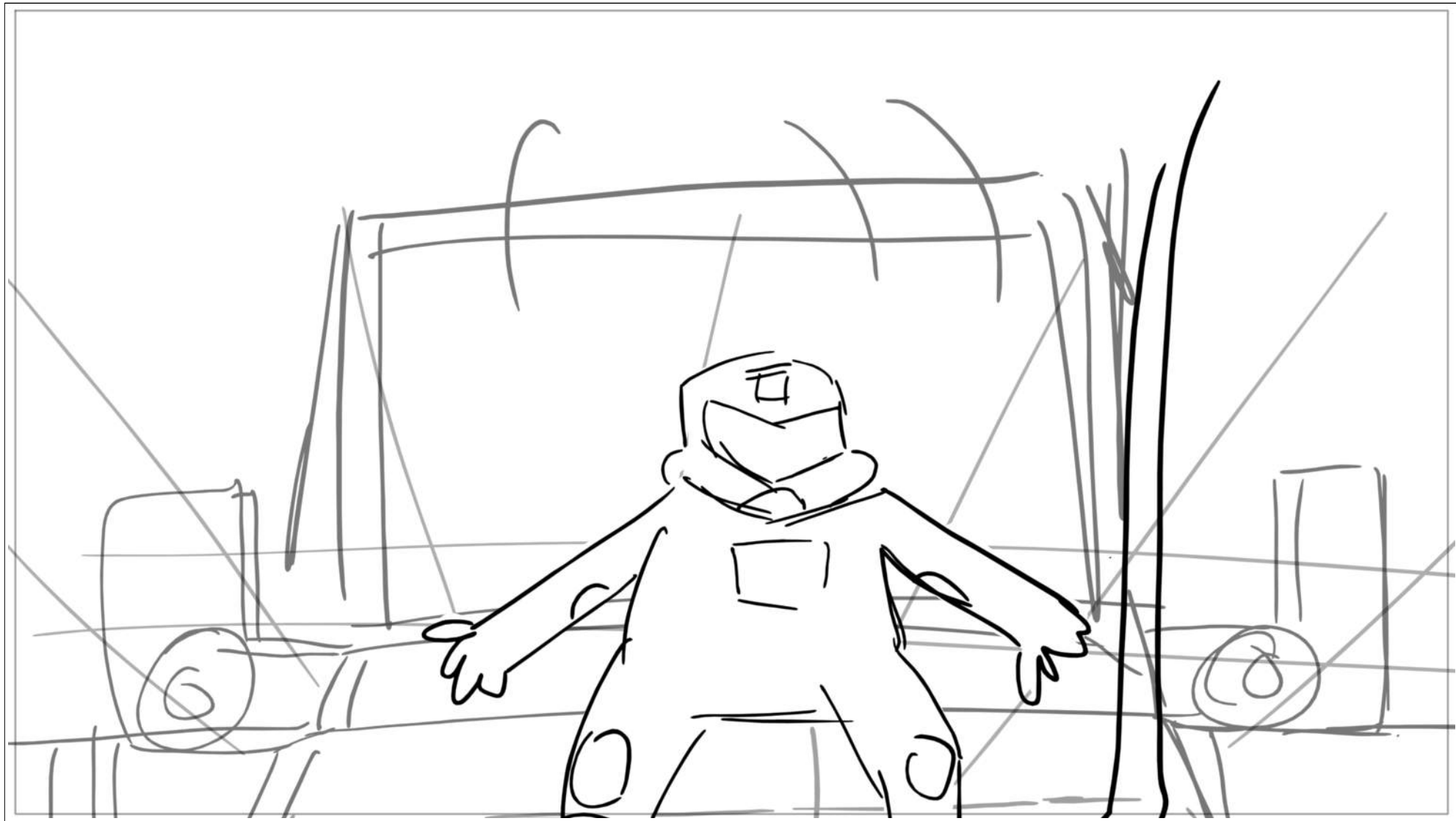

Scene	Duration	Panel	Duration
1	05:28:03	233	01:00

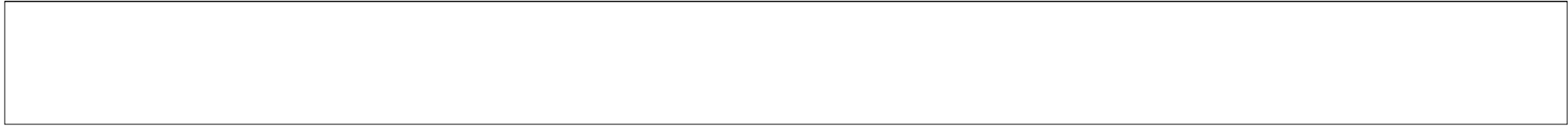
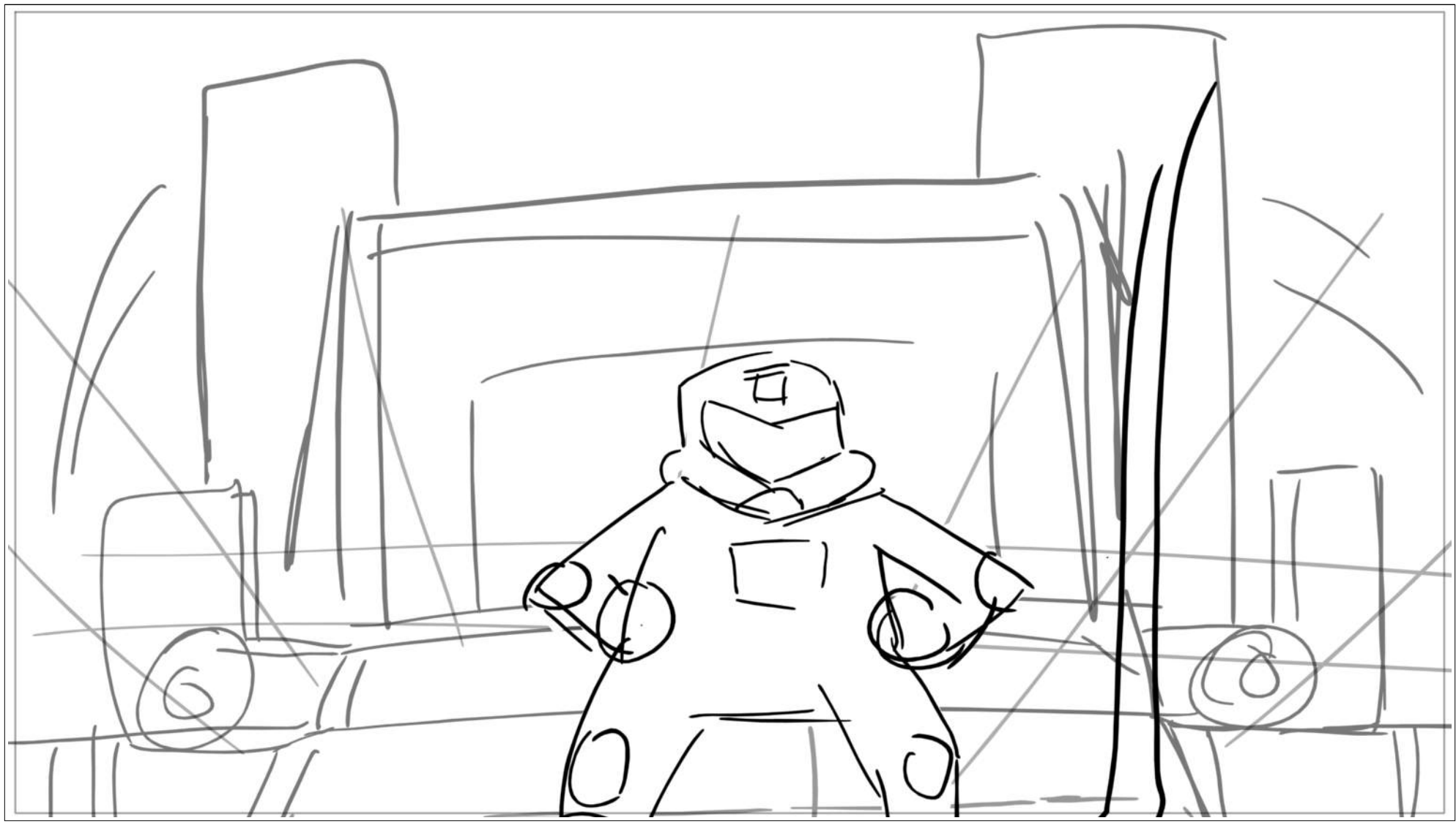

Scene	Duration	Panel	Duration
1	05:28:03	234	01:00



Scene	Duration	Panel	Duration
1	05:28:03	235	01:00



Scene	Duration	Panel	Duration
1	05:28:03	236	01:00

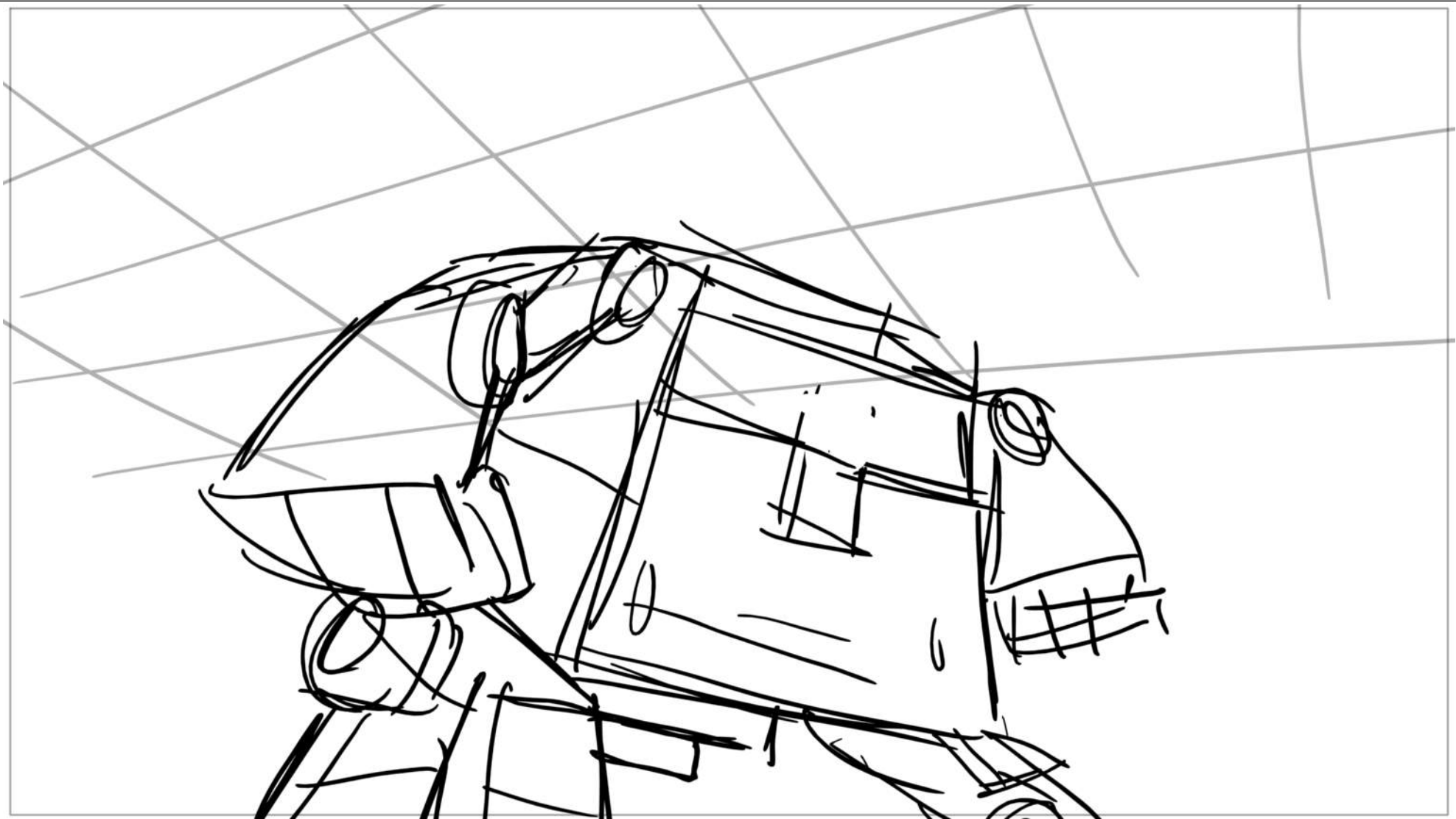

Scene	Duration	Panel	Duration
1	05:28:03	237	01:00

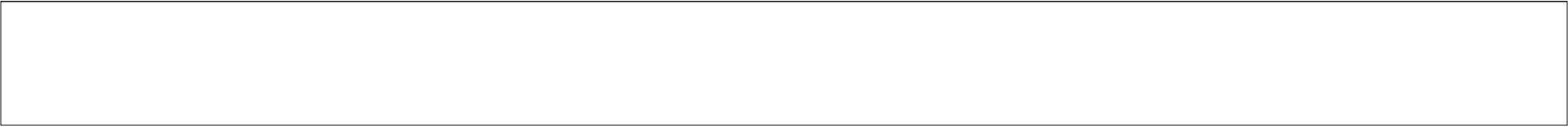
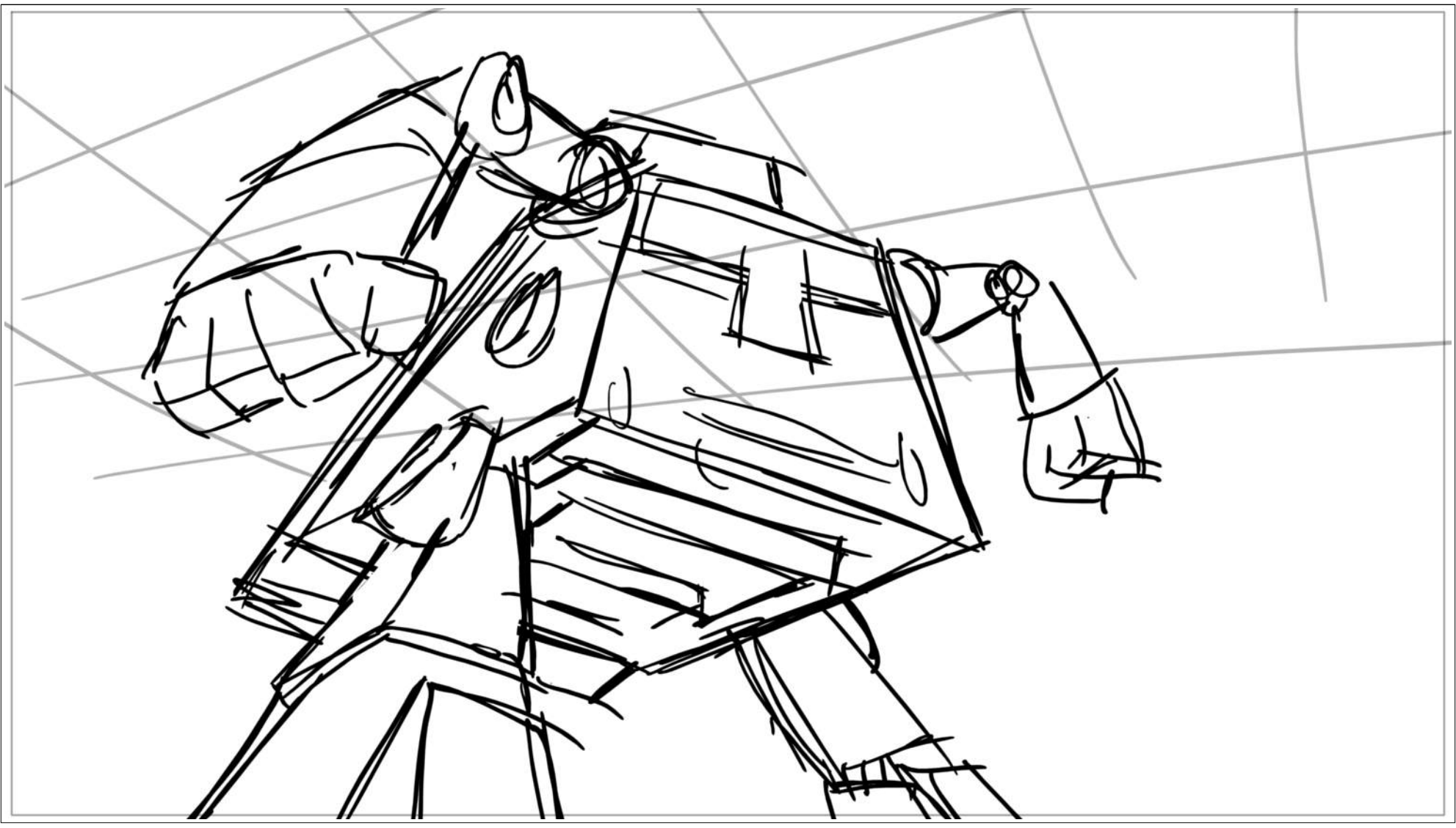

Scene	1	Duration	05:28:03	Panel	238	Duration	01:00
-------	---	----------	----------	-------	-----	----------	-------

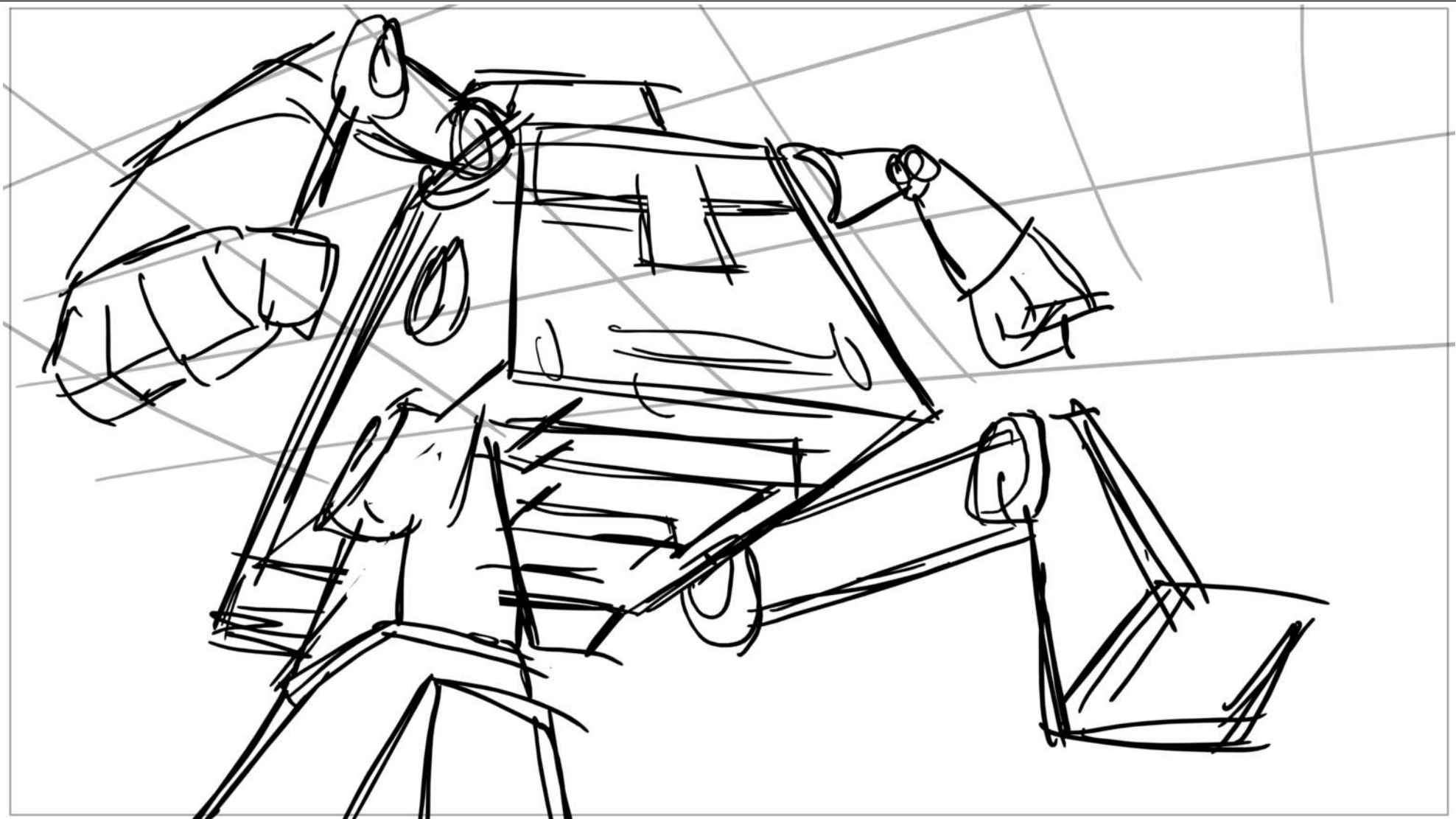

Scene	Duration	Panel	Duration
1	05:28:03	239	01:00

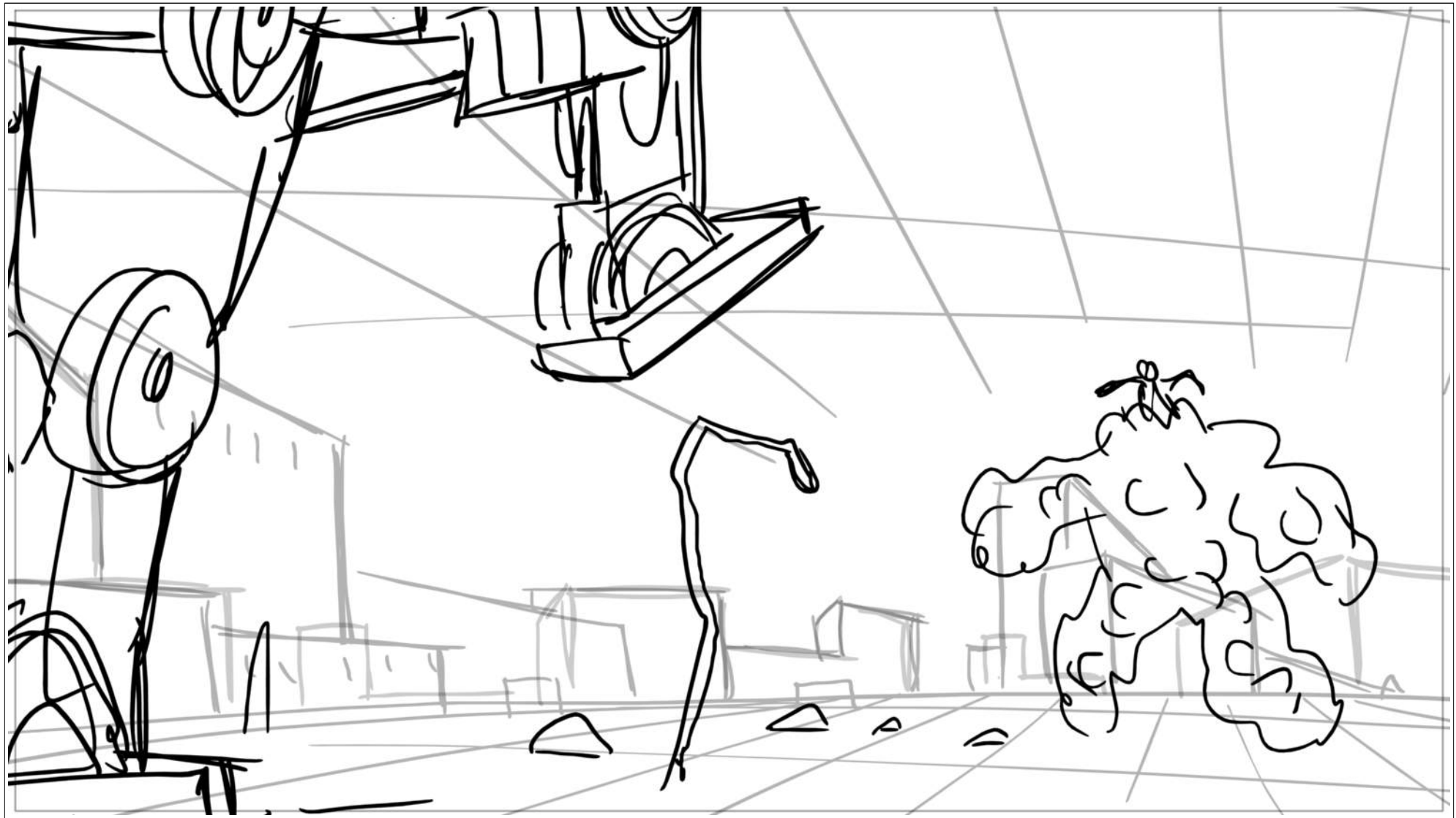

Scene	Duration	Panel	Duration
1	05:28:03	240	01:00

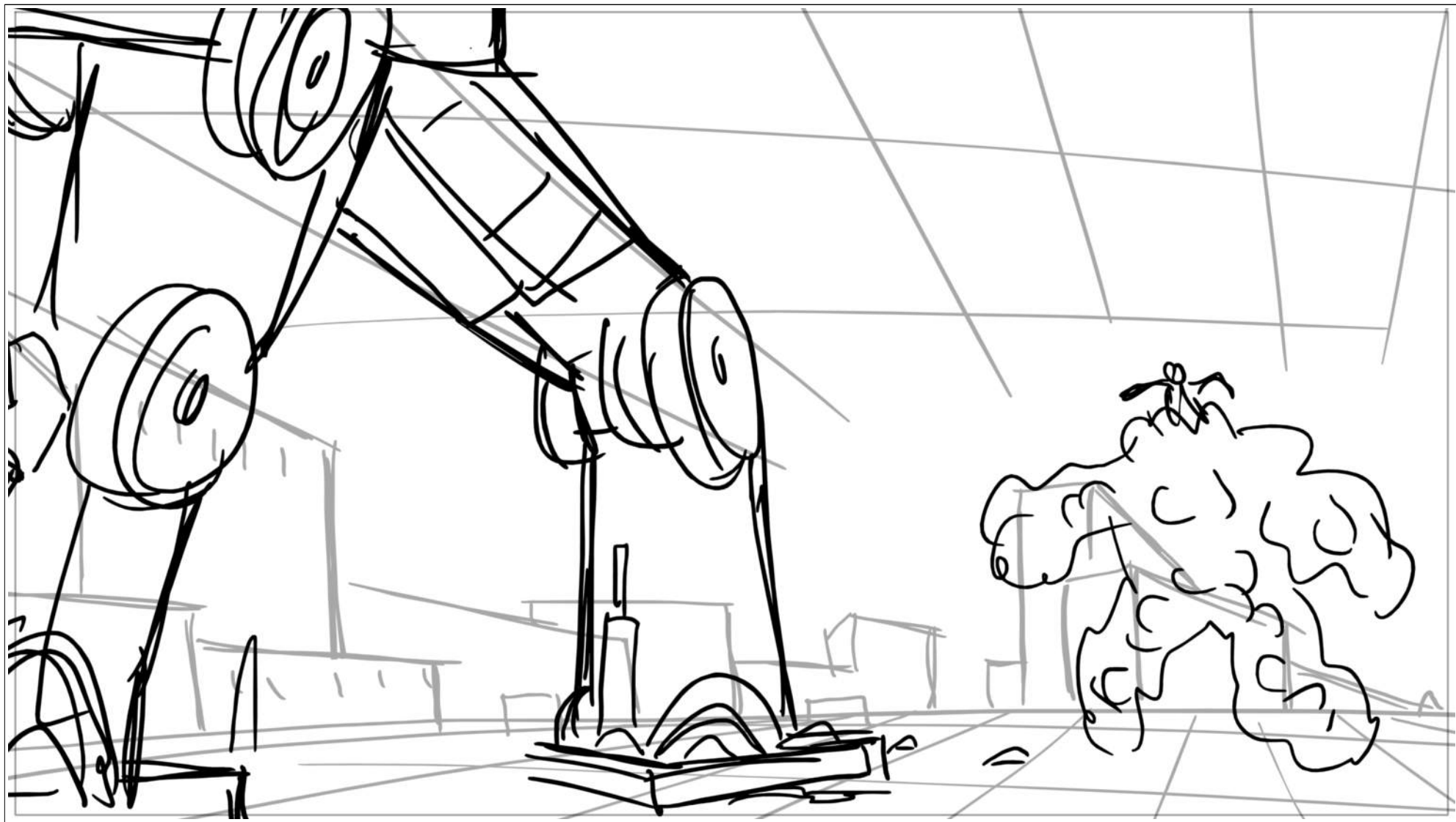

Scene	Duration	Panel	Duration
1	05:28:03	241	01:00

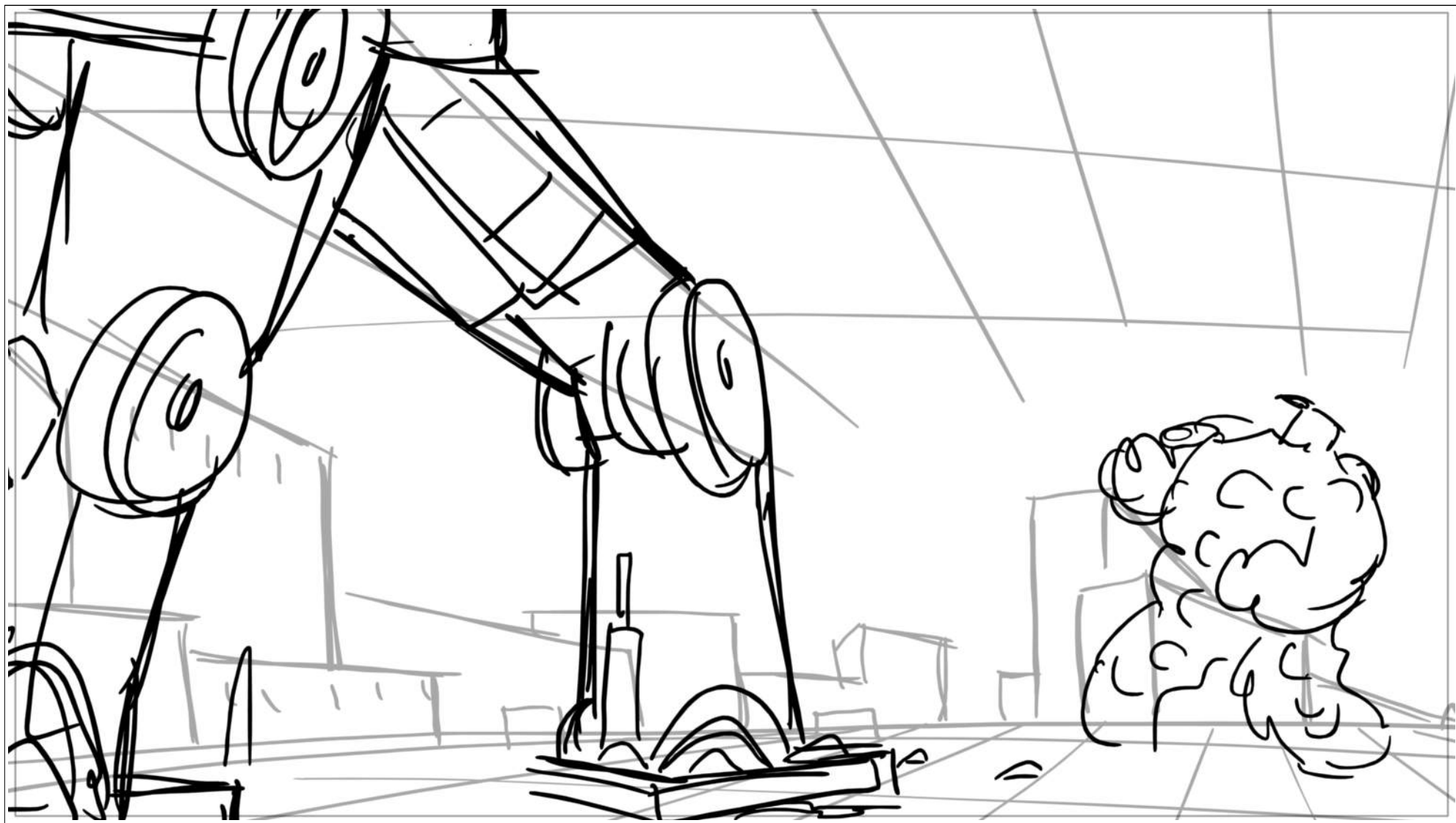

Scene	1	Duration	05:28:03	Panel	242	Duration	01:00
-------	---	----------	----------	-------	-----	----------	-------

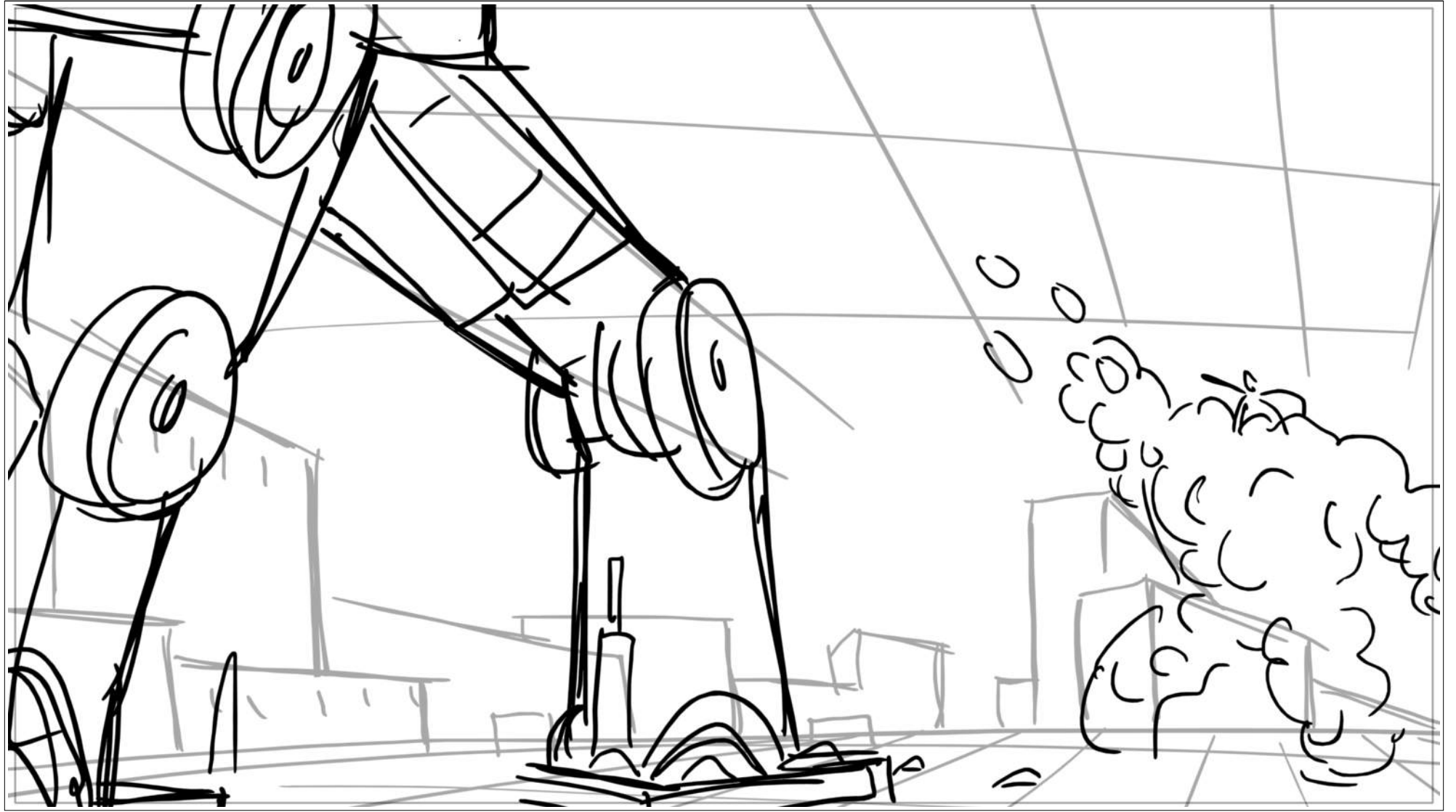

Scene	Duration	Panel	Duration
1	05:28:03	243	01:00

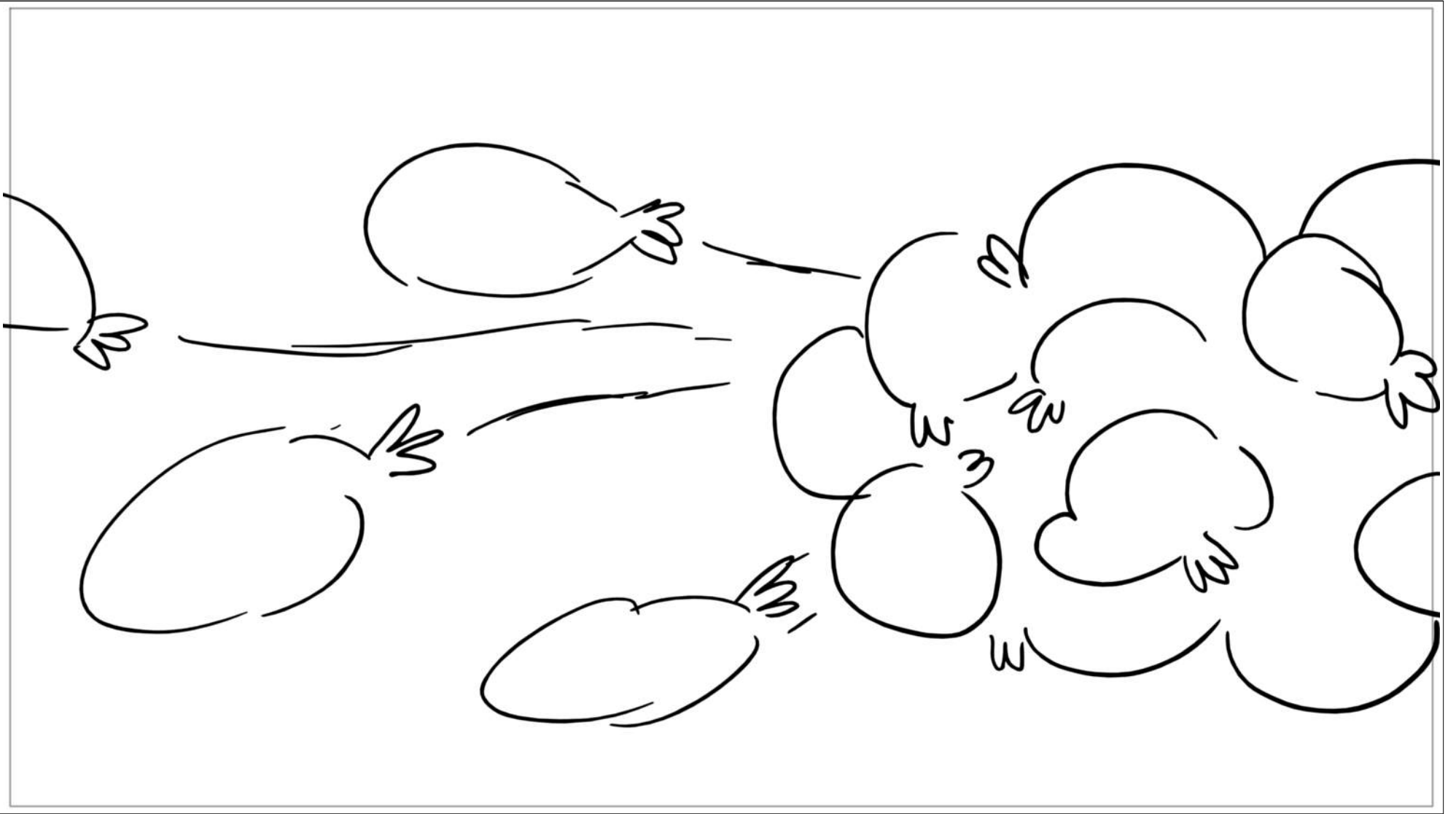

Scene	Duration	Panel	Duration
1	05:28:03	244	01:00

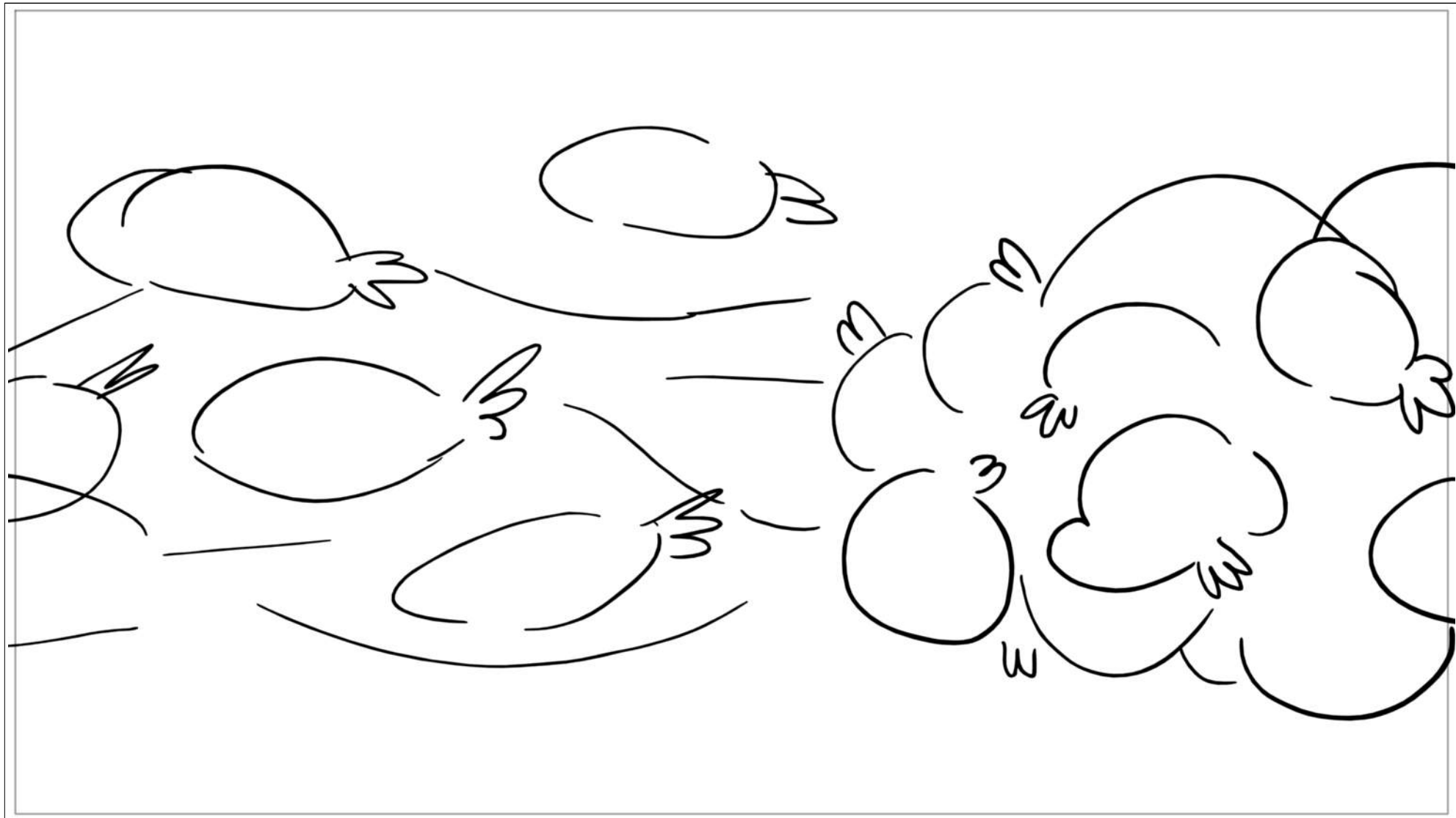

Scene	Duration	Panel	Duration
1	05:28:03	245	01:00

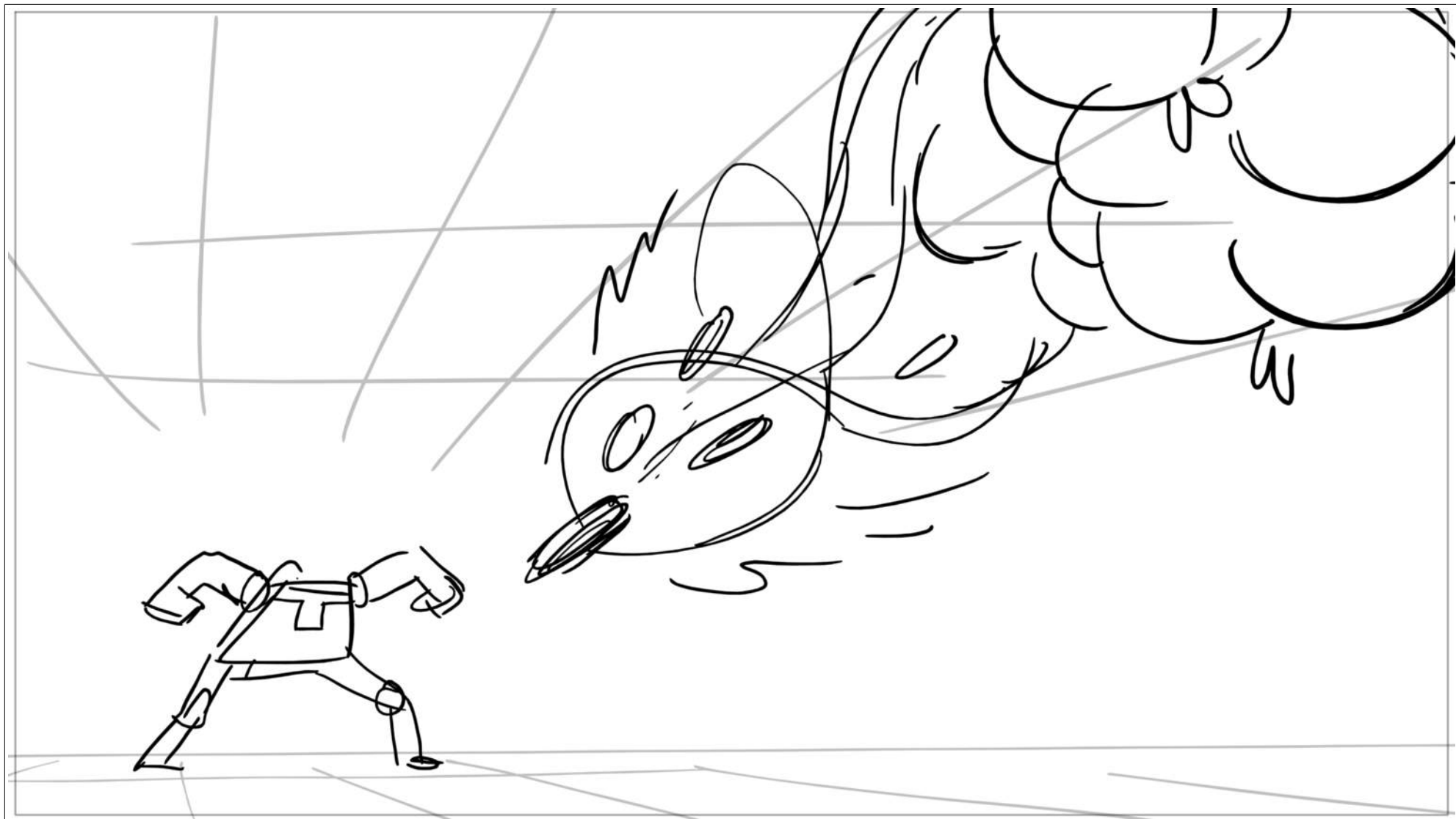

Scene	1	Duration	05:28:03	Panel	246	Duration	01:00
-------	---	----------	----------	-------	-----	----------	-------

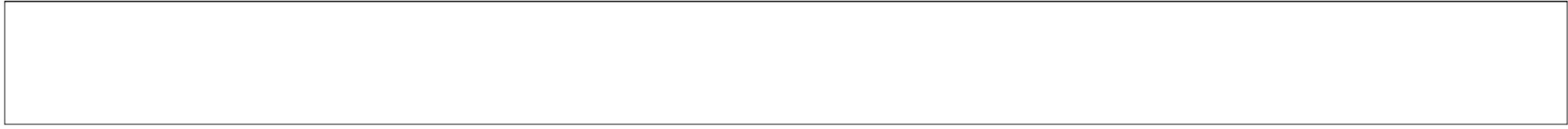
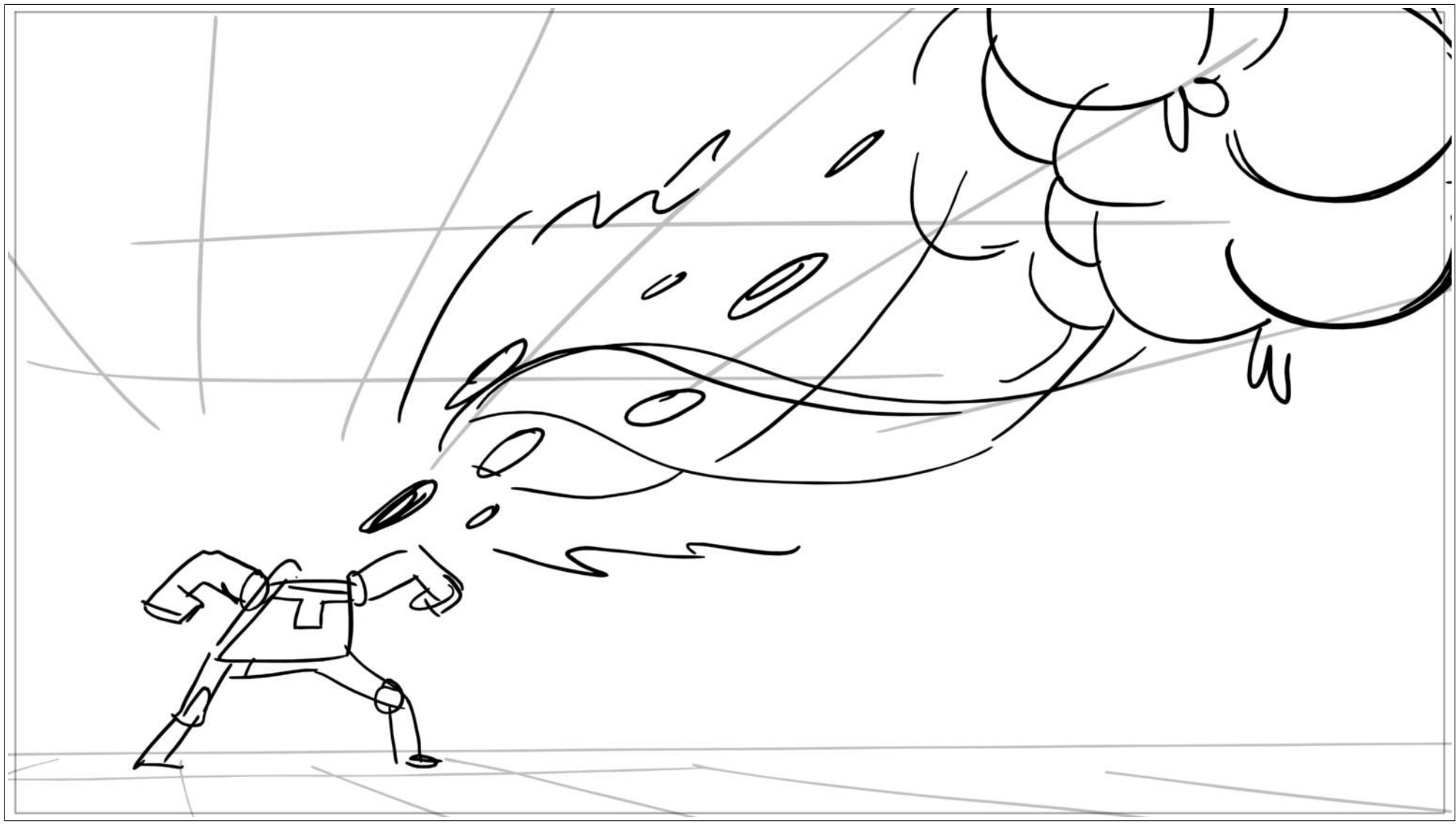

Scene	1	Duration	05:28:03	Panel	247	Duration	01:00
-------	---	----------	----------	-------	-----	----------	-------

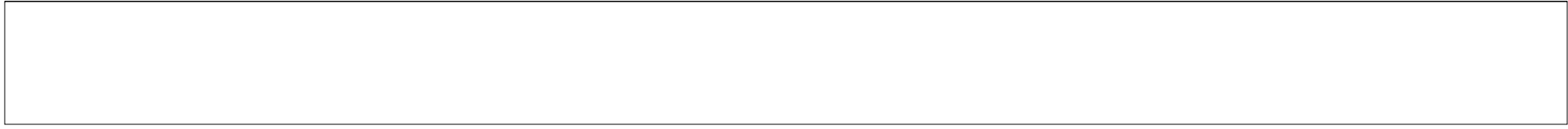
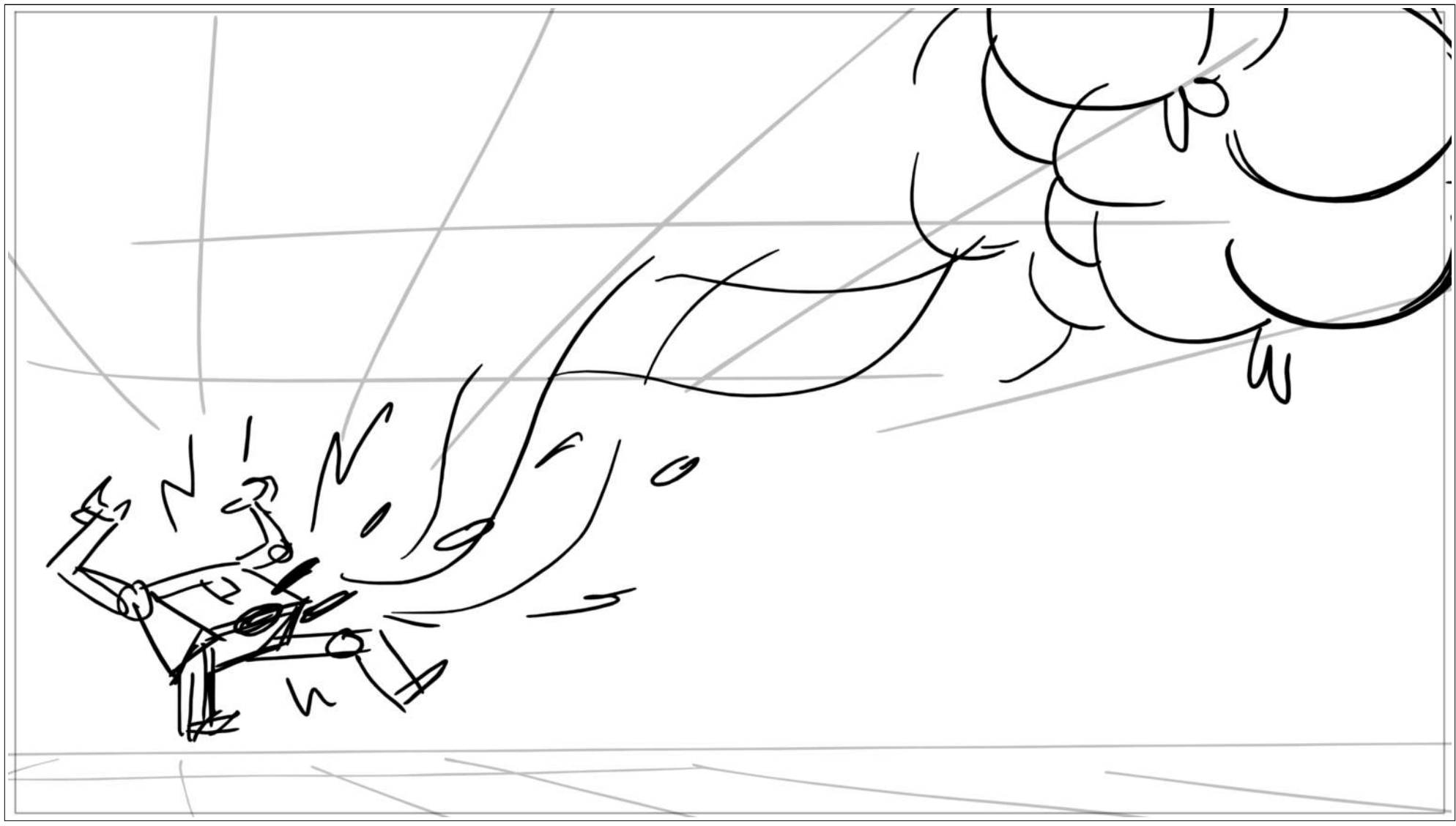

Scene	Duration	Panel	Duration
1	05:28:03	248	01:00

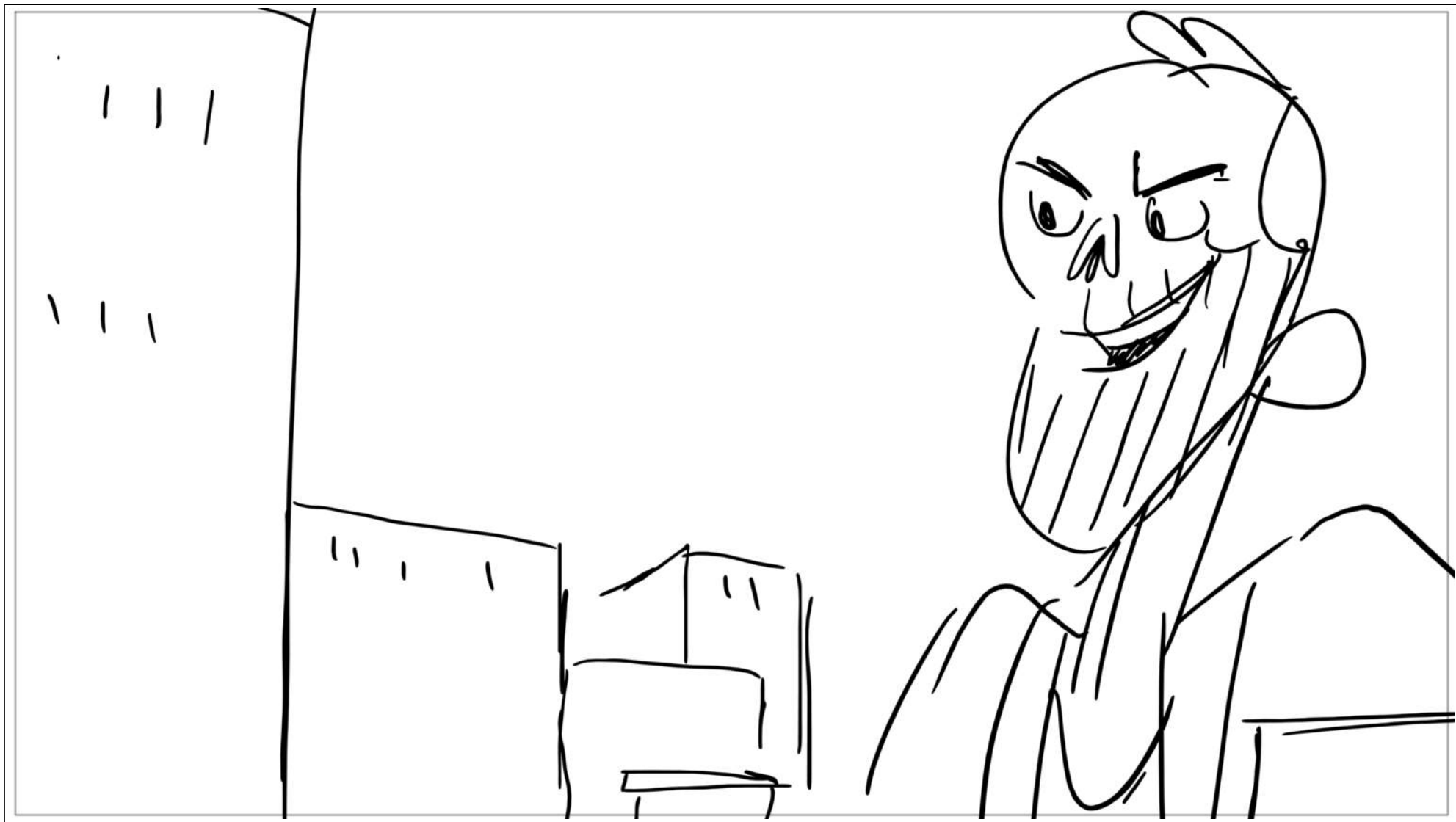

Scene	Duration	Panel	Duration
1	05:28:03	249	01:00

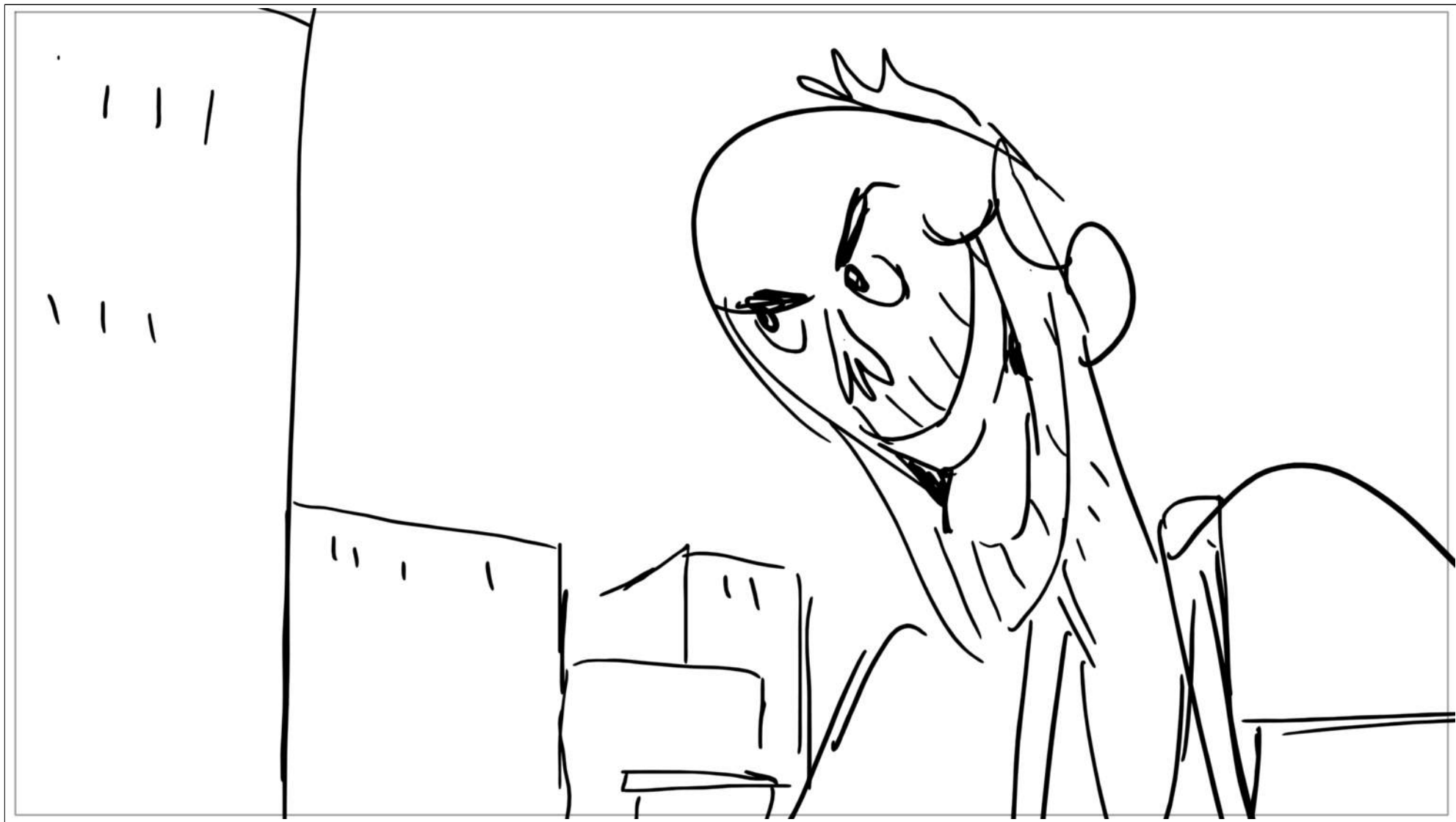

Scene	Duration	Panel	Duration
1	05:28:03	250	01:00

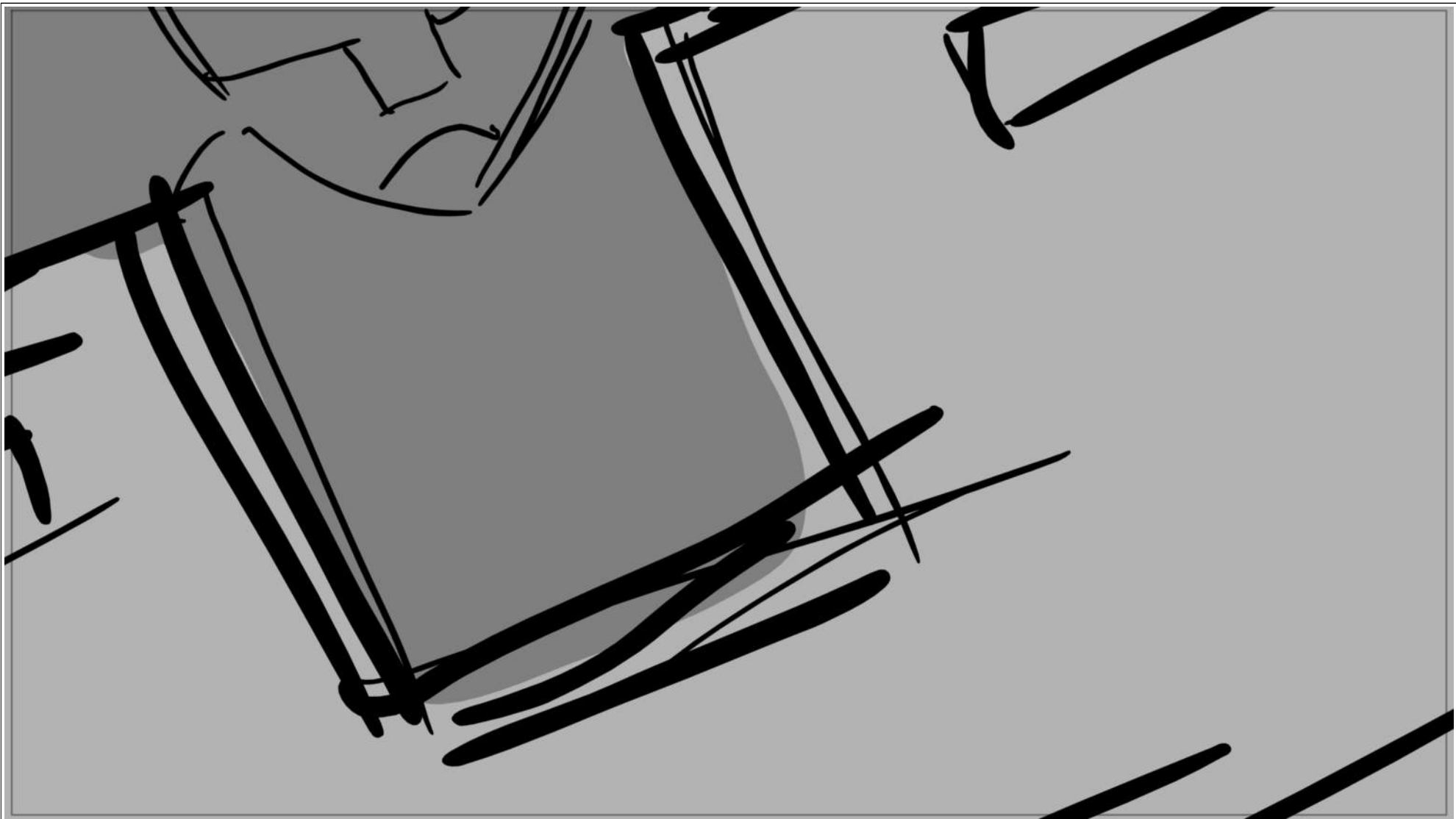

Scene	Duration	Panel	Duration
1	05:28:03	251	01:00



Scene	Duration	Panel	Duration
1	05:28:03	252	01:00

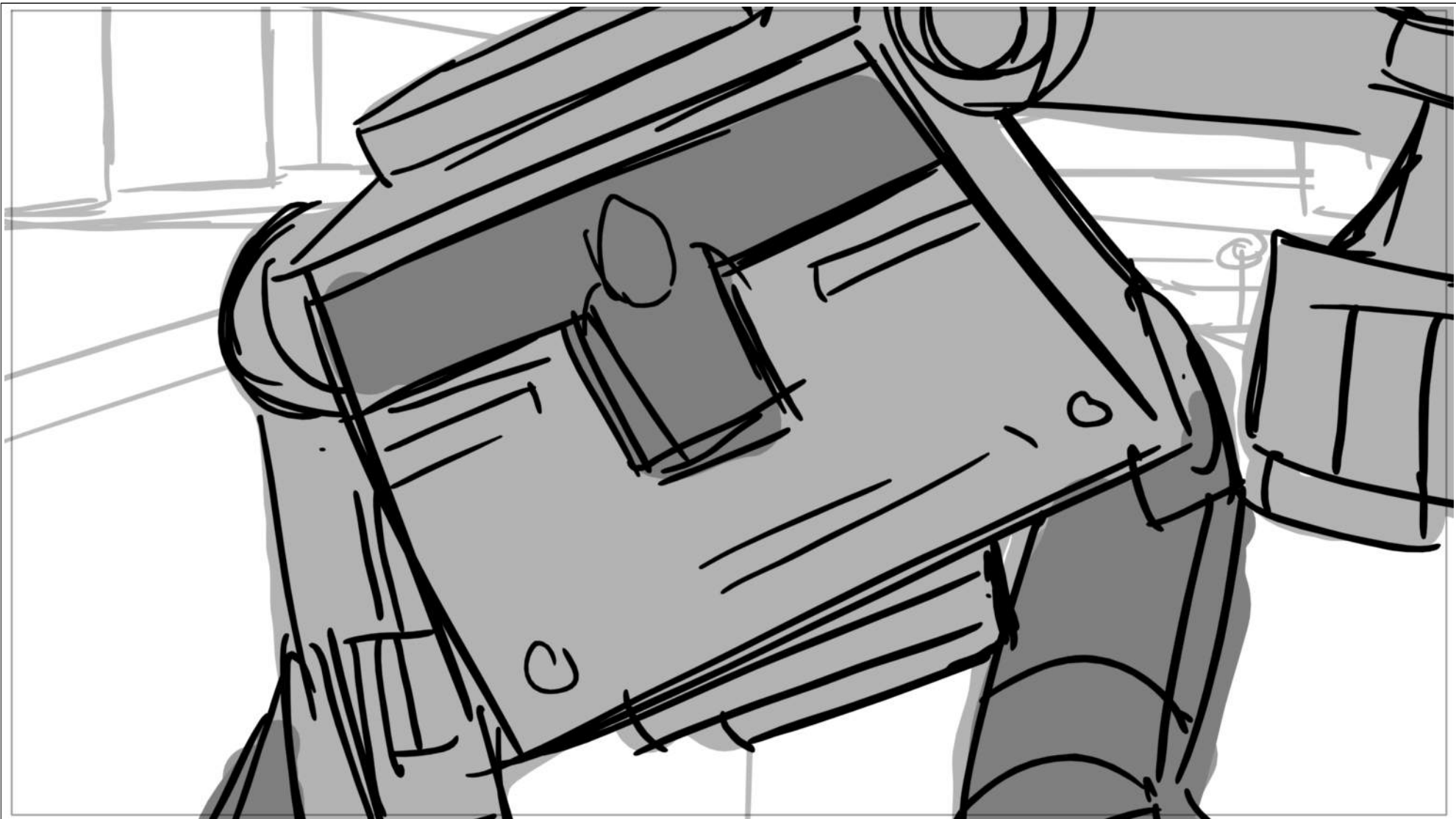

Scene	Duration	Panel	Duration
1	05:28:03	253	01:00

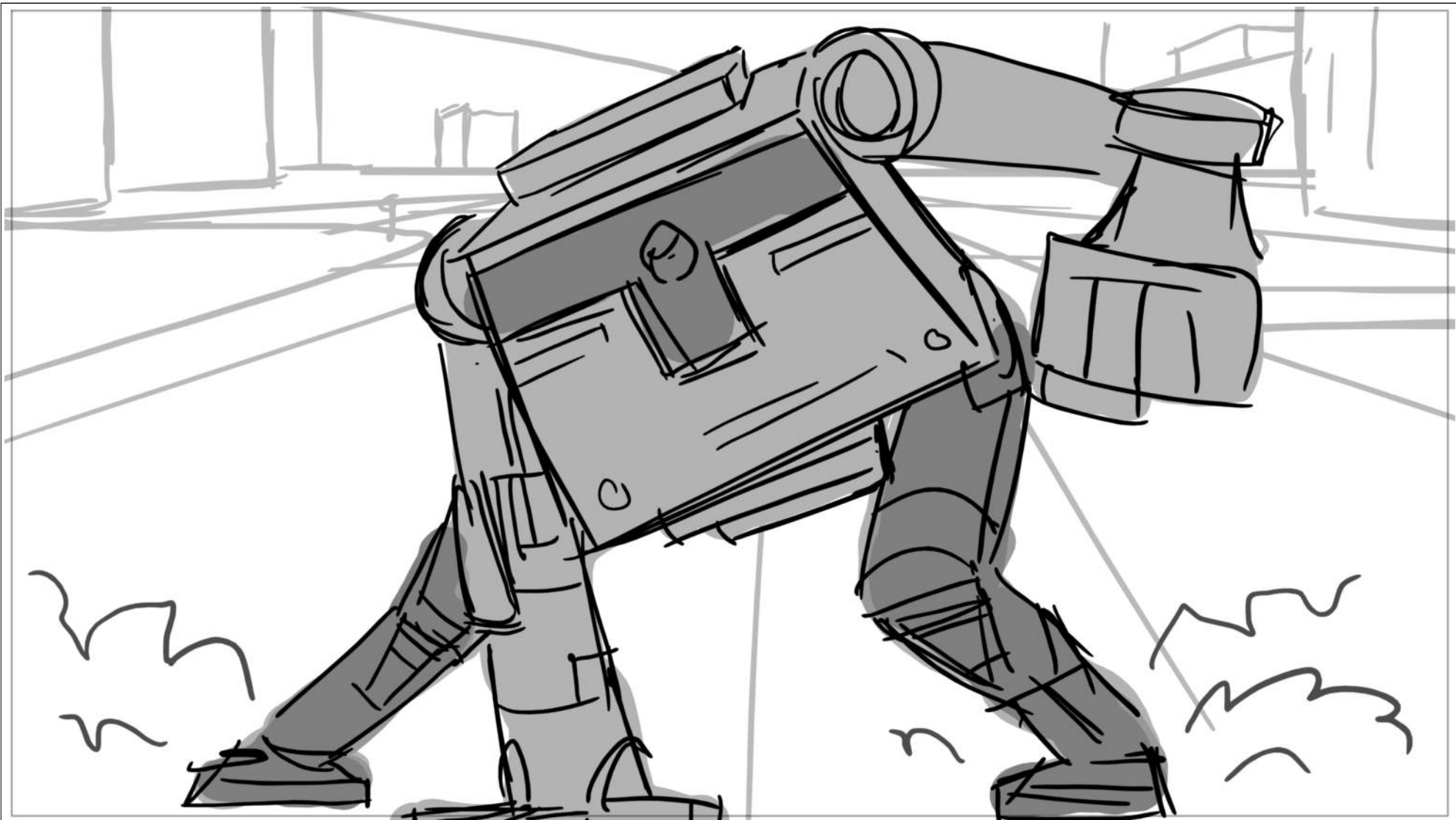

Scene	Duration	Panel	Duration
1	05:28:03	254	01:00

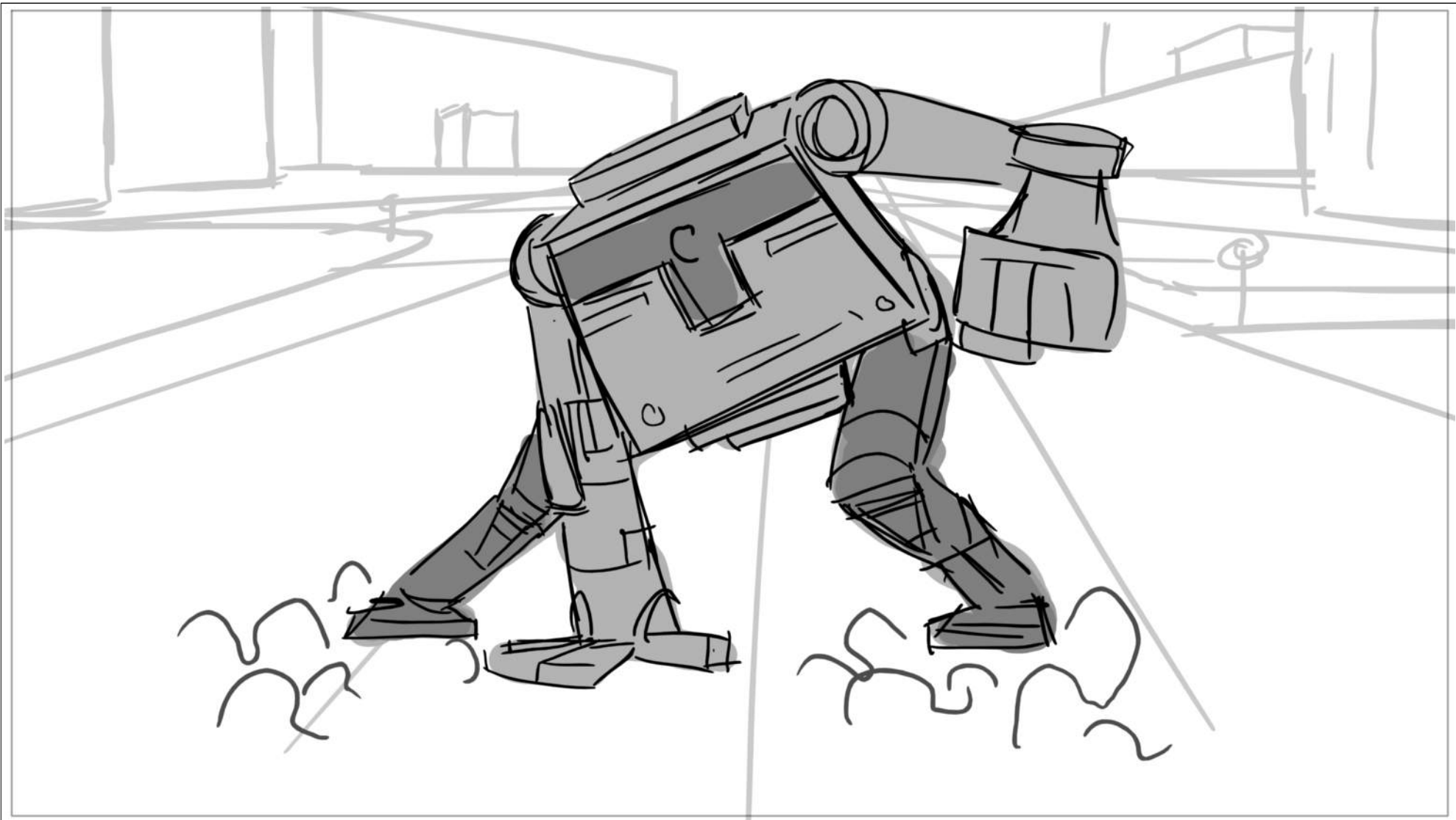

Scene	Duration	Panel	Duration
1	05:28:03	255	01:00

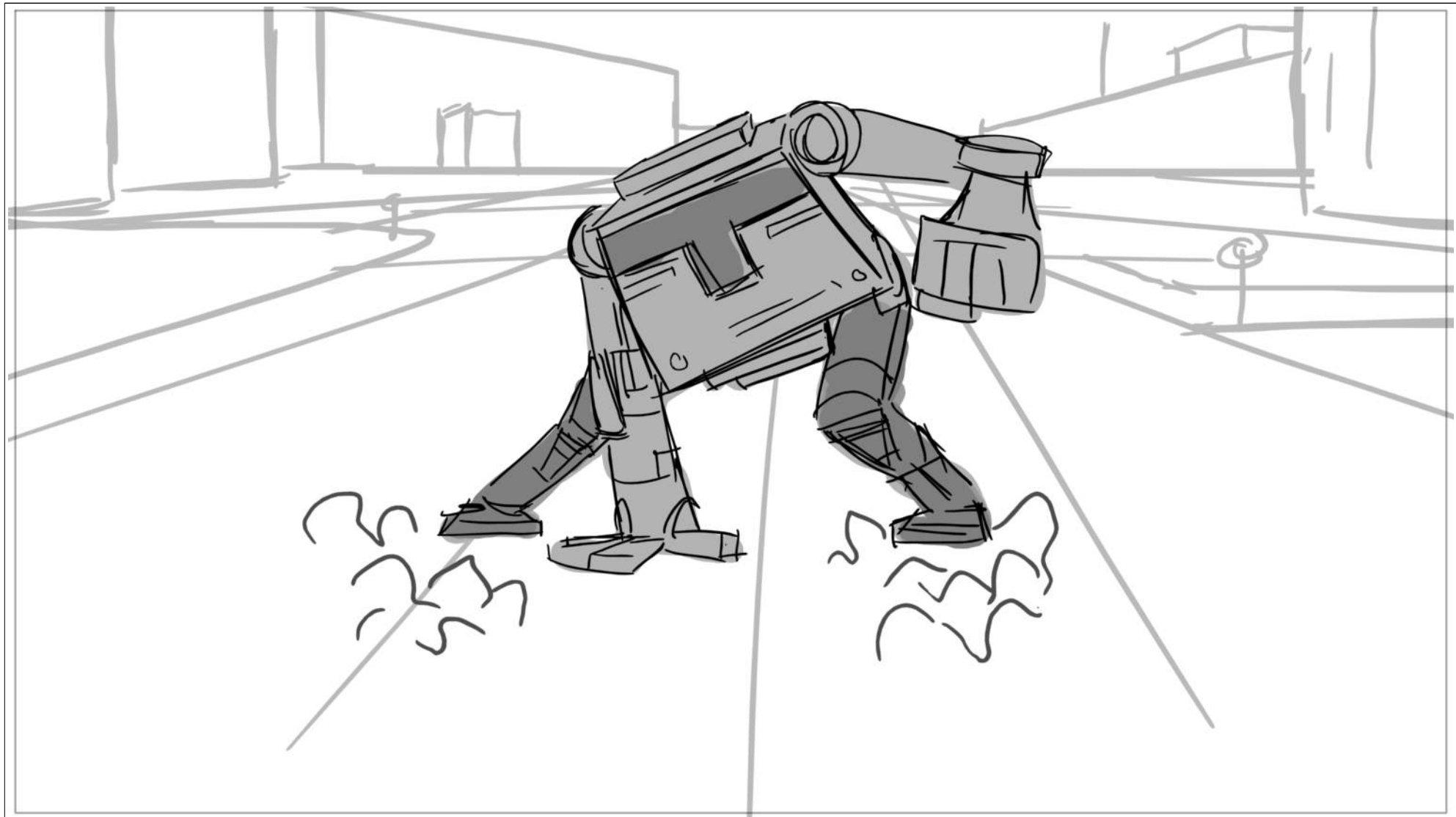

Scene	Duration	Panel	Duration
1	05:28:03	256	01:00

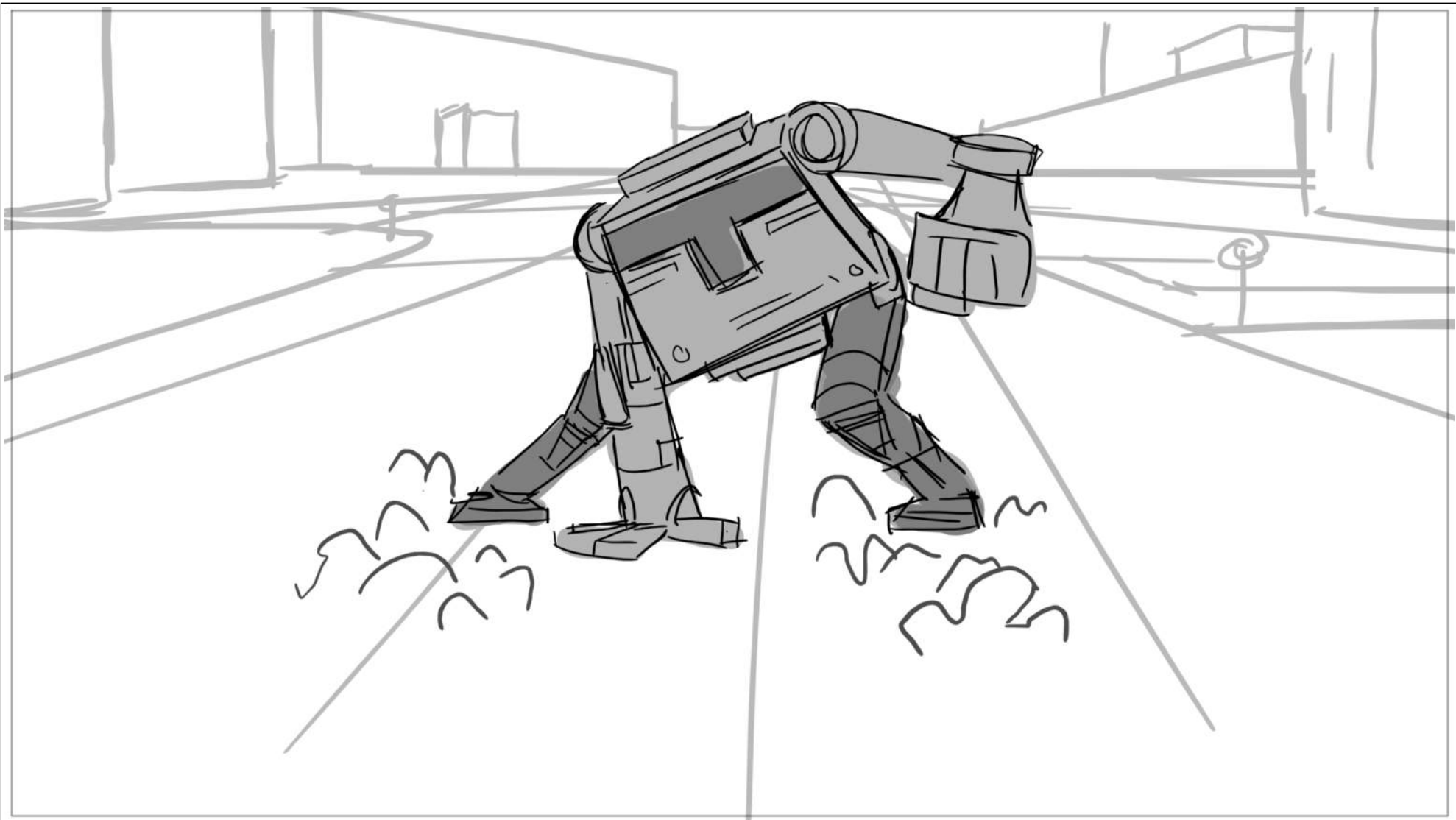

Scene	Duration	Panel	Duration
1	05:28:03	257	01:00



Scene	Duration	Panel	Duration
1	05:28:03	258	01:00



Scene	Duration	Panel	Duration
1	05:28:03	259	01:00

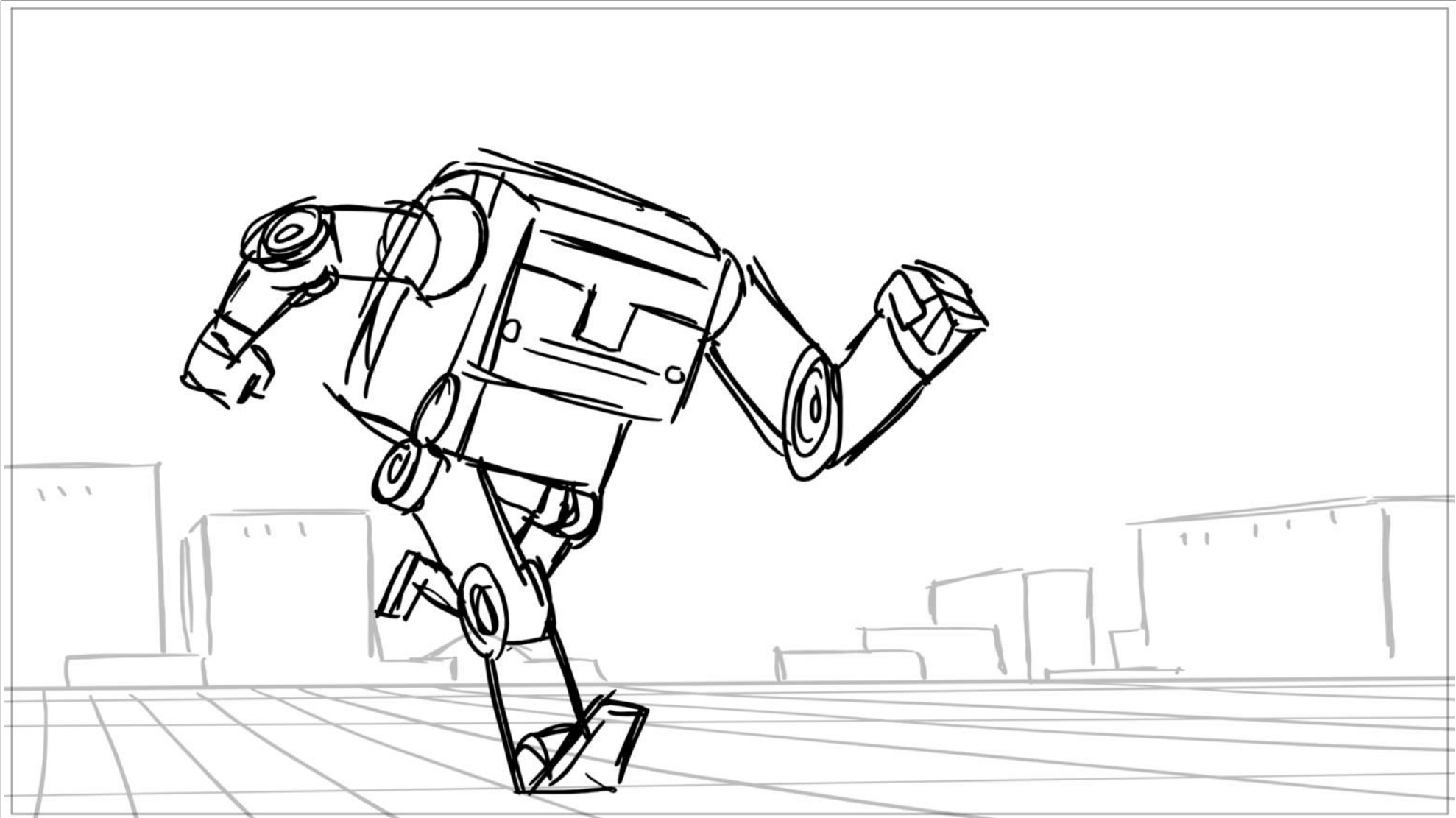

Scene	Duration	Panel	Duration
1	05:28:03	260	01:00

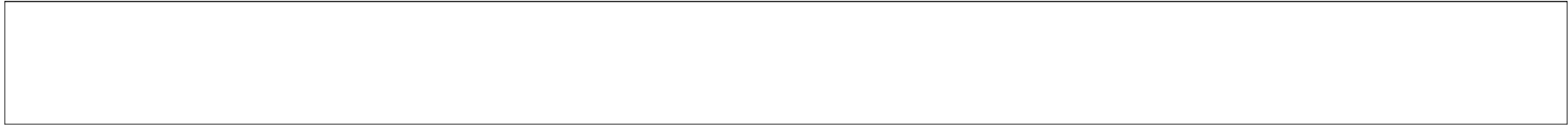

Scene	Duration	Panel	Duration
1	05:28:03	261	01:00

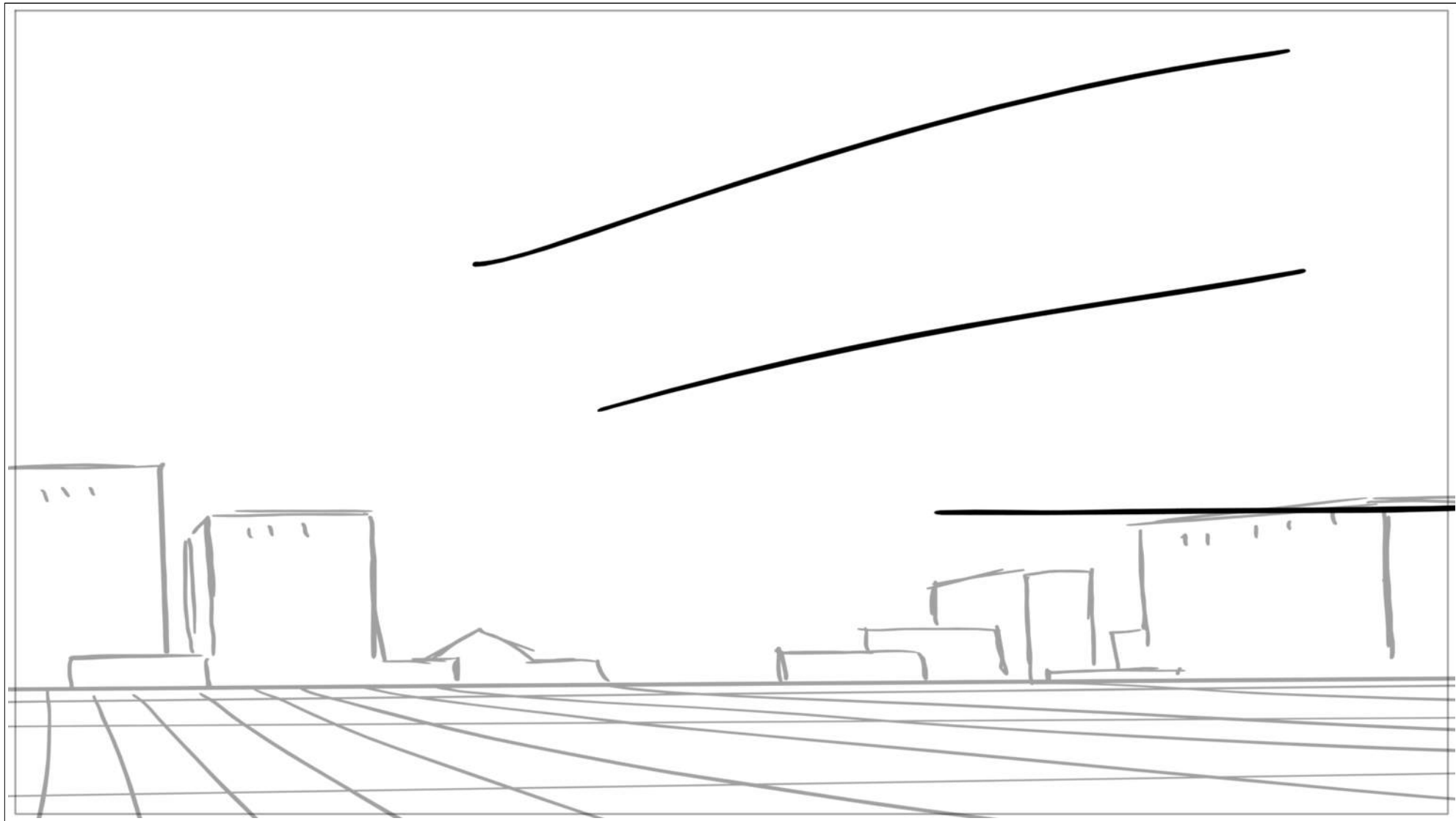

Scene	Duration	Panel	Duration
1	05:28:03	262	01:00

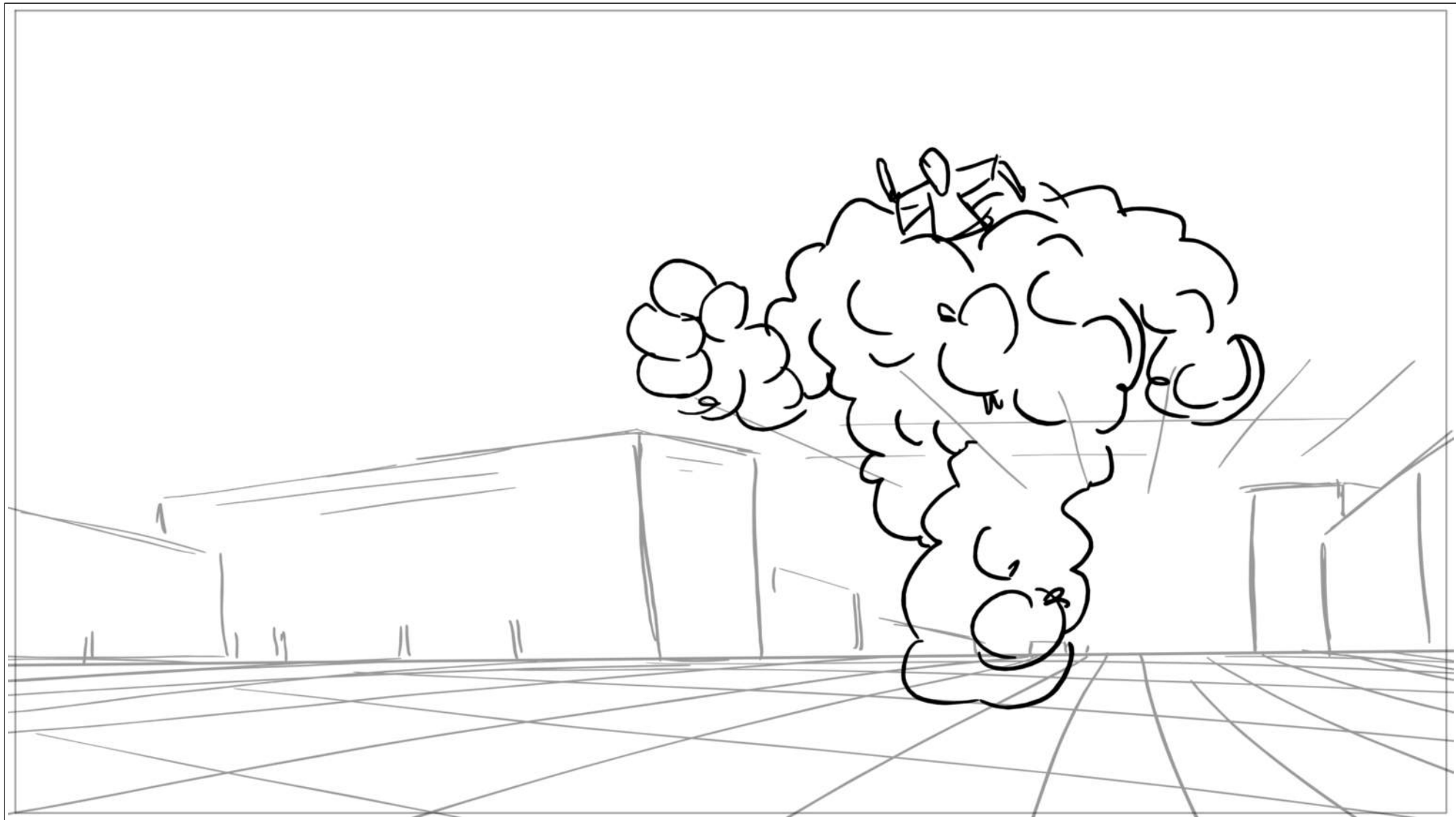

Scene	Duration	Panel	Duration
1	05:28:03	263	01:00

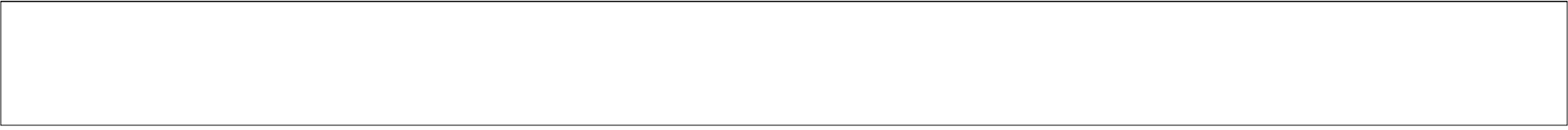

Scene	Duration	Panel	Duration
1	05:28:03	264	01:00

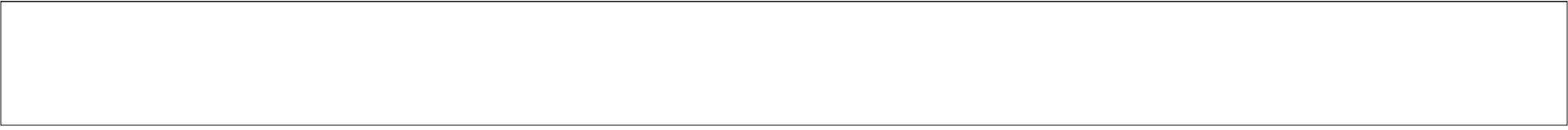
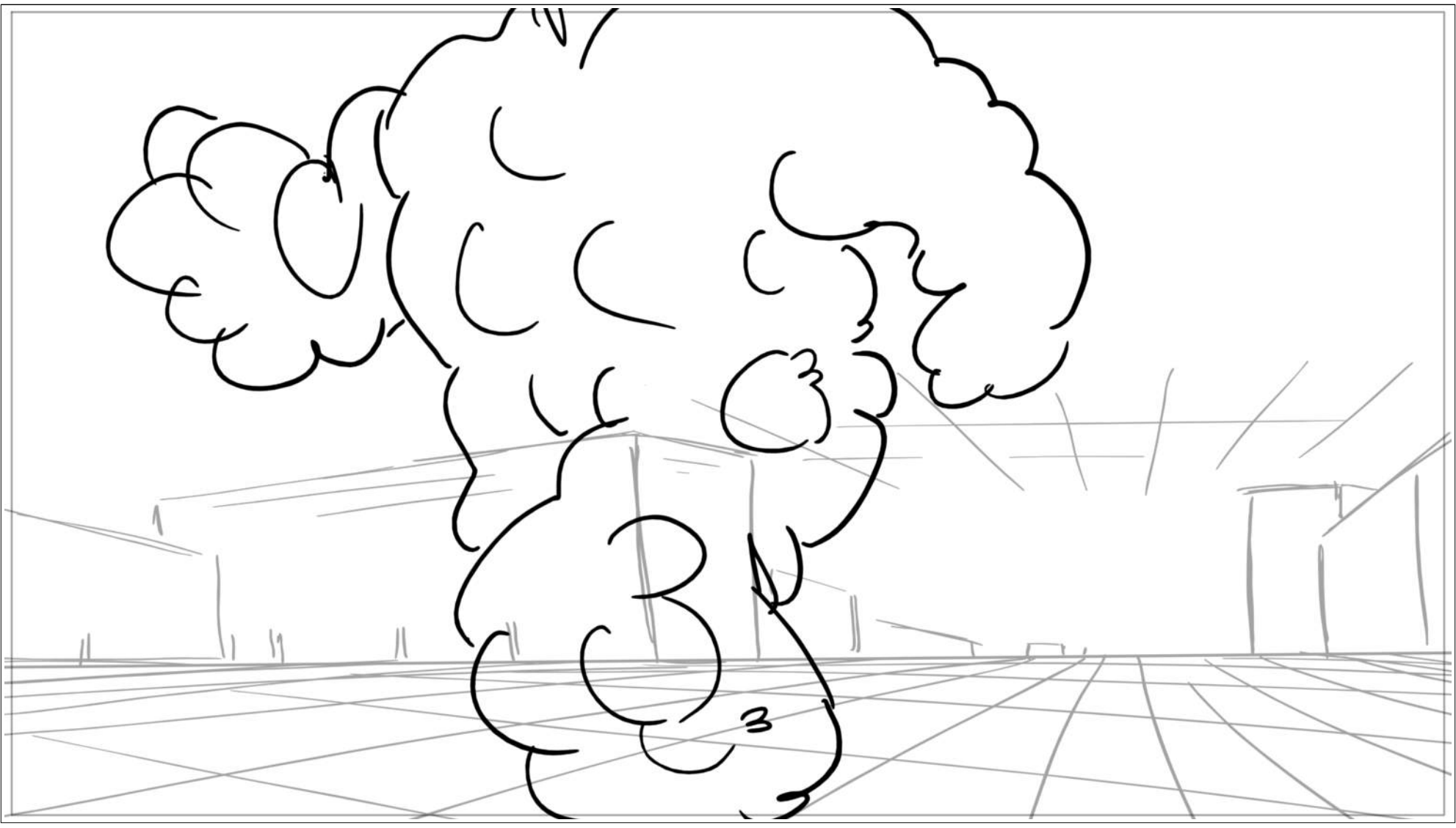

Scene	Duration	Panel	Duration
1	05:28:03	265	01:00



Scene	Duration	Panel	Duration
1	05:28:03	266	01:00

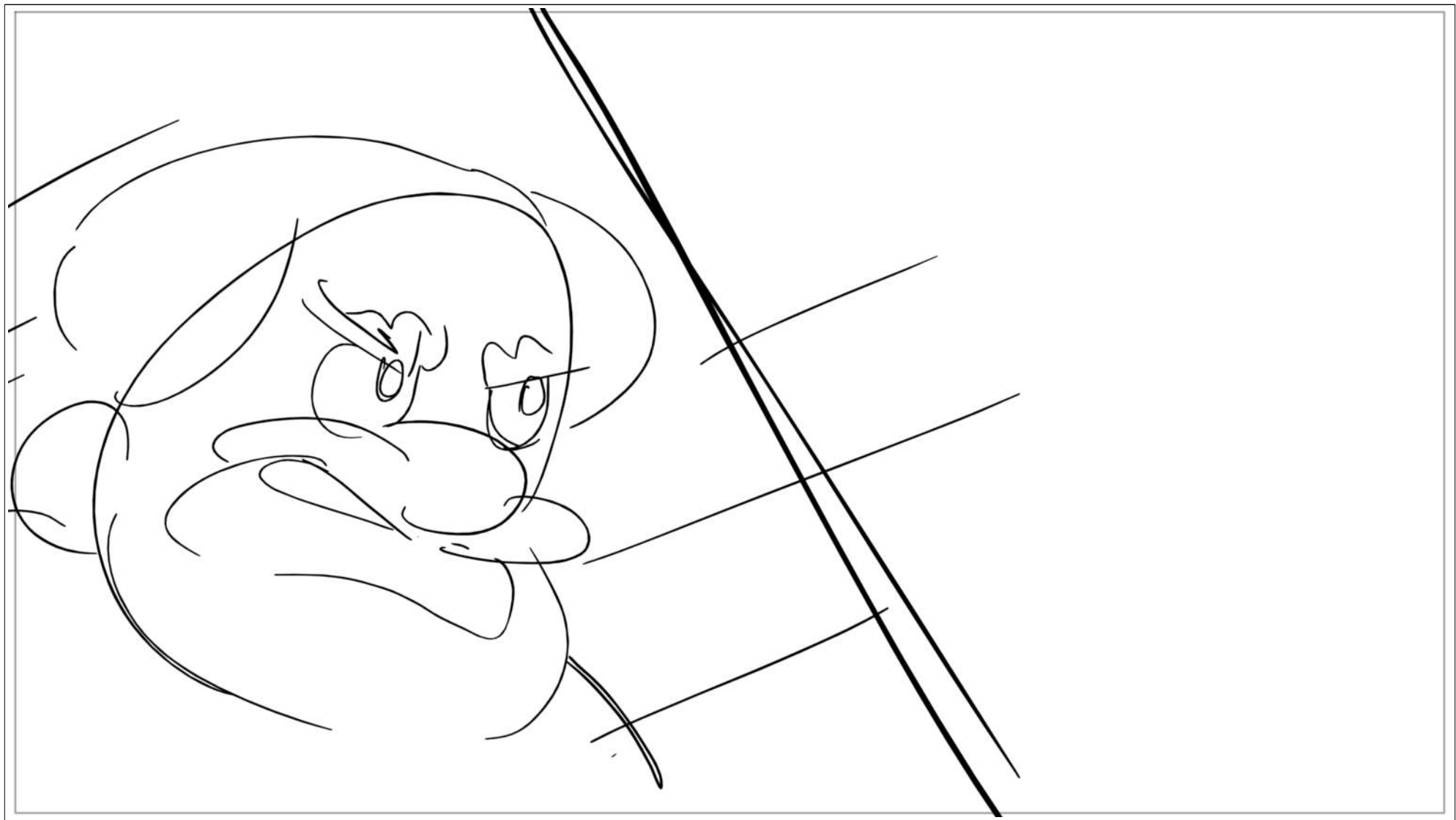

Scene	Duration	Panel	Duration
1	05:28:03	267	01:00



Scene	Duration	Panel	Duration
1	05:28:03	268	01:00



Scene	Duration	Panel	Duration
1	05:28:03	269	01:00

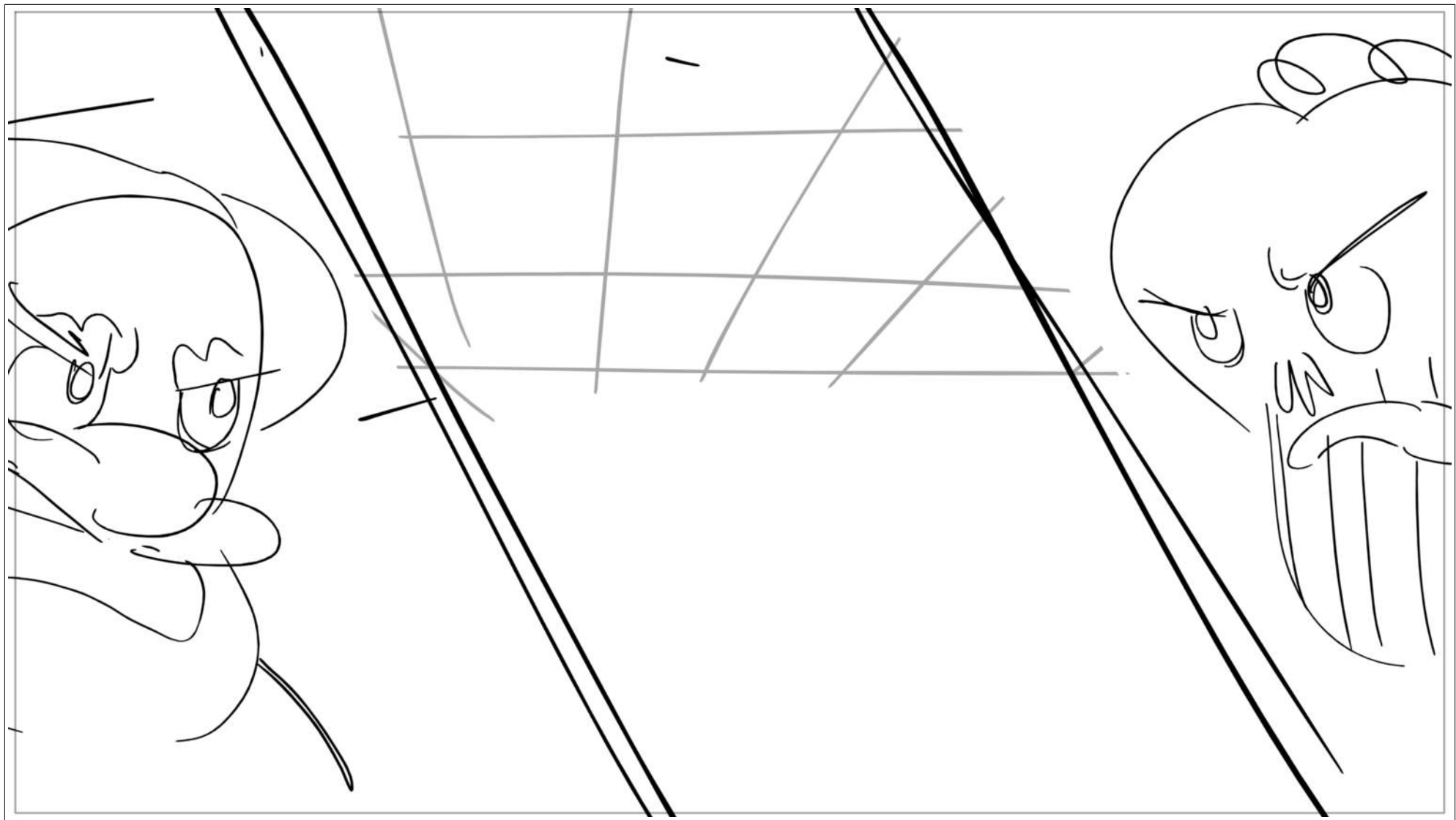

Scene	Duration	Panel	Duration
1	05:28:03	270	01:00

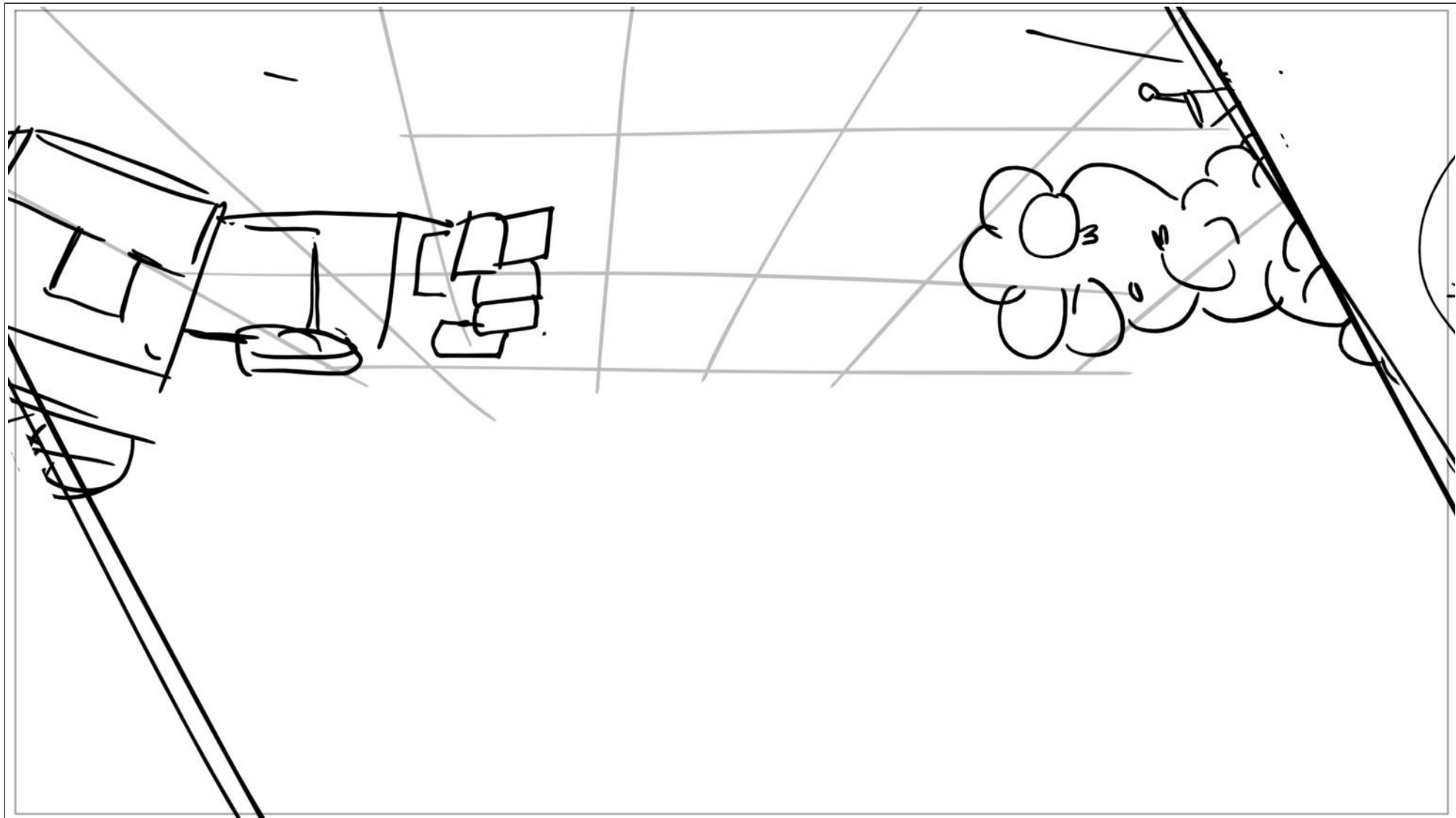

Scene	Duration	Panel	Duration
1	05:28:03	271	01:00

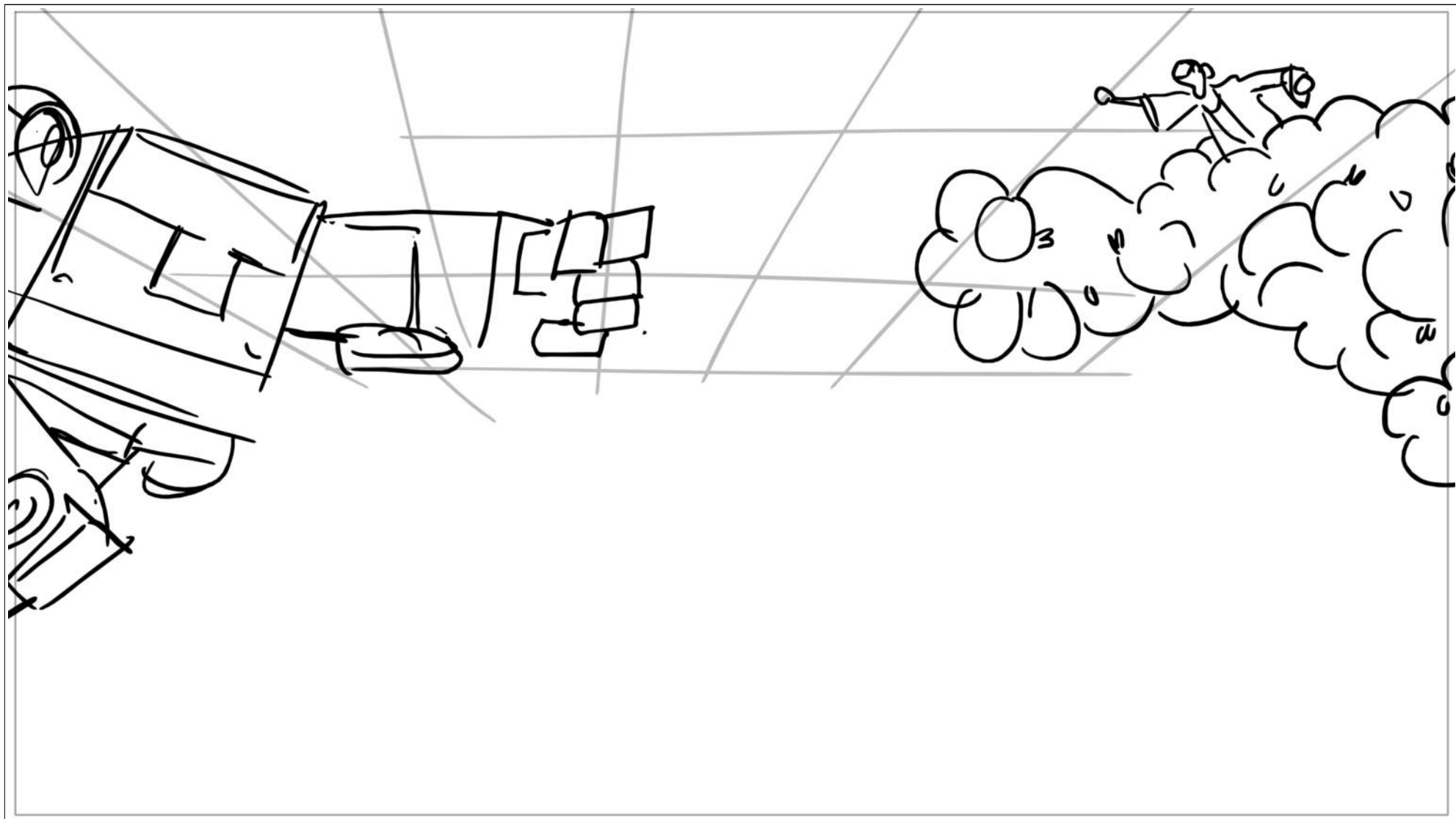

Scene	1	Duration	05:28:03	Panel	272	Duration	01:00
-------	---	----------	----------	-------	-----	----------	-------

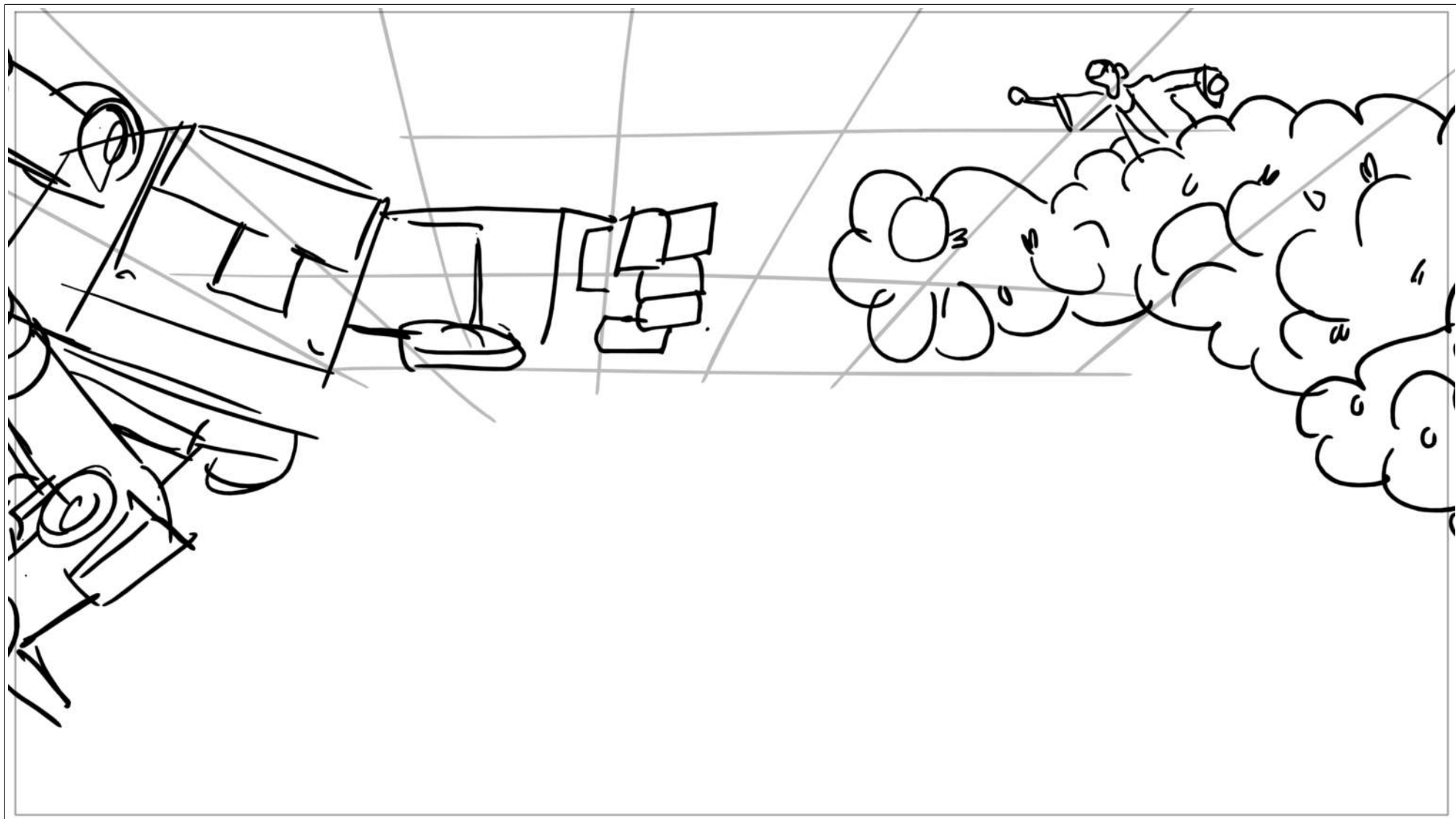

Scene	Duration	Panel	Duration
1	05:28:03	273	01:00



Scene	Duration	Panel	Duration
1	05:28:03	274	01:00

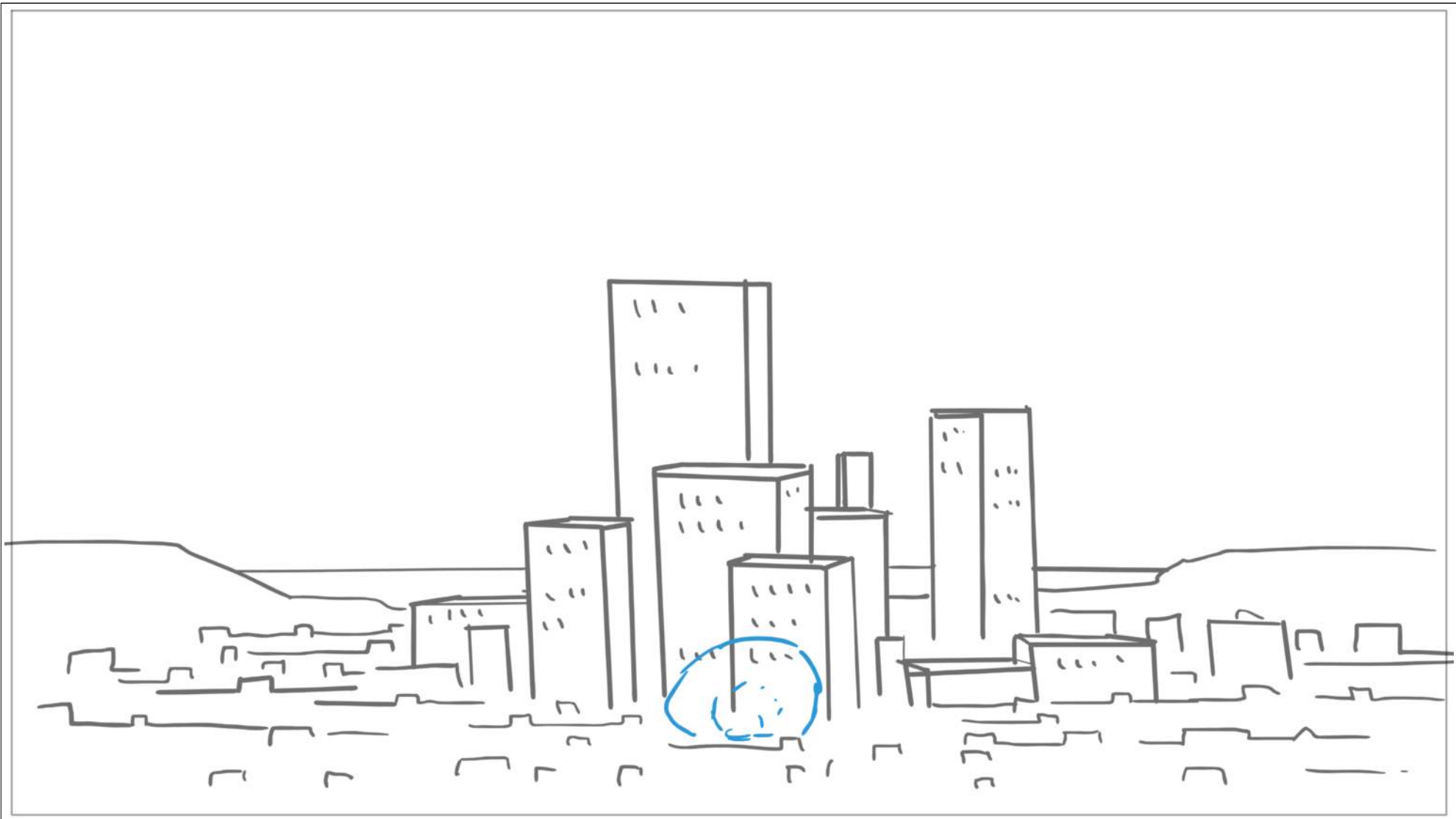

Scene	Duration	Panel	Duration
1	05:28:03	275	01:00

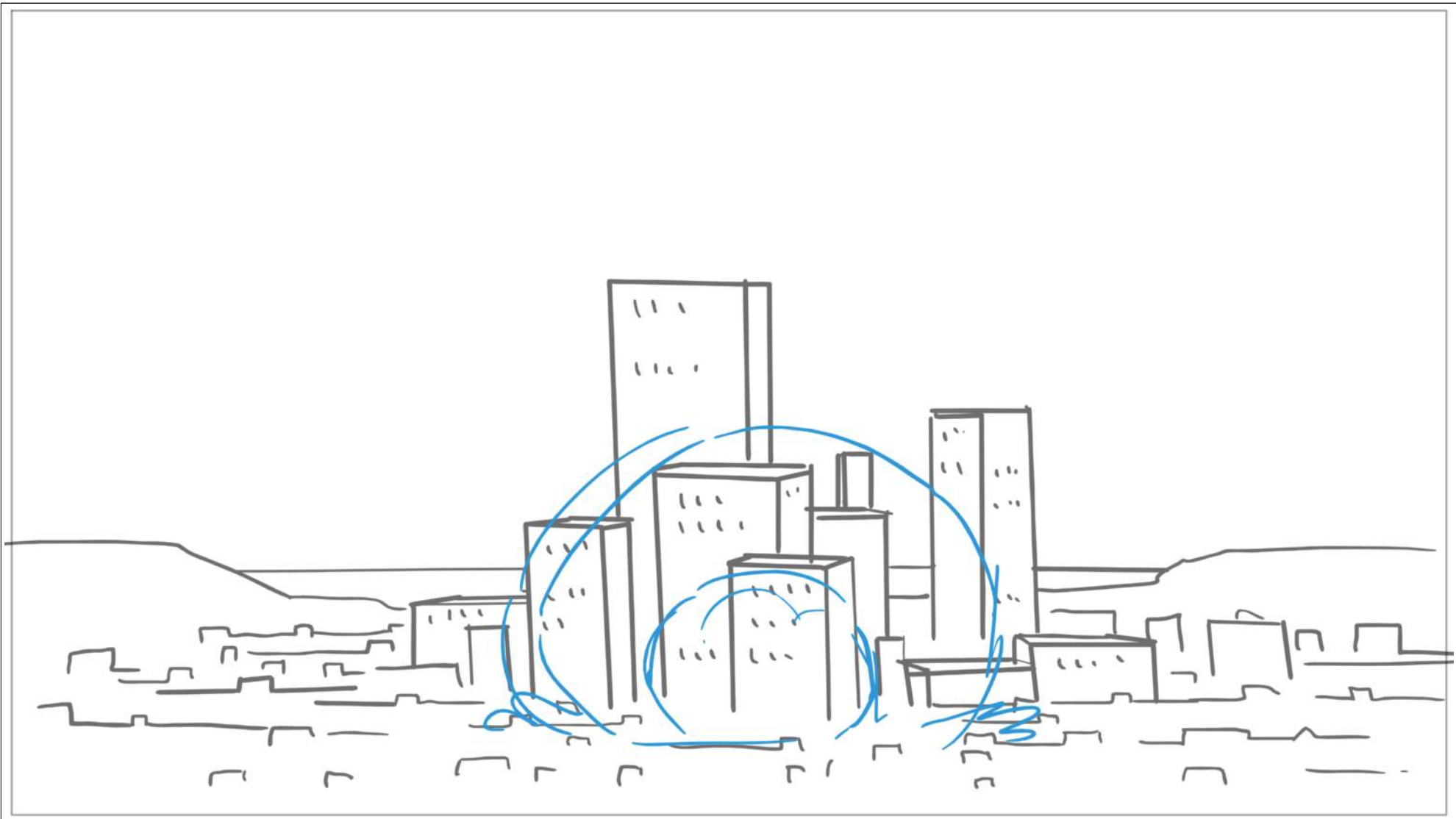

Scene	Duration	Panel	Duration
1	05:28:03	276	01:00

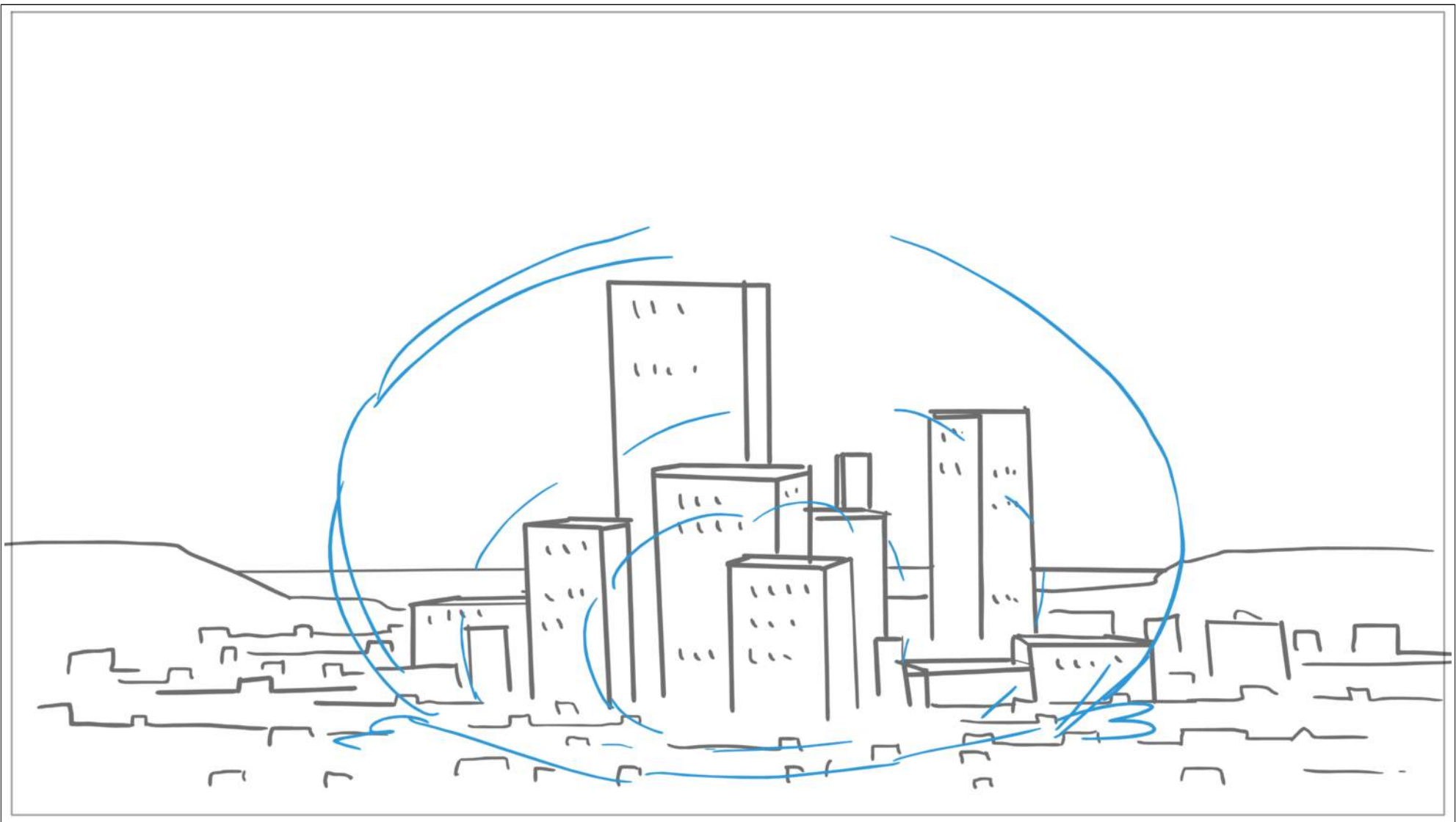

Scene	Duration	Panel	Duration
1	05:28:03	277	01:00

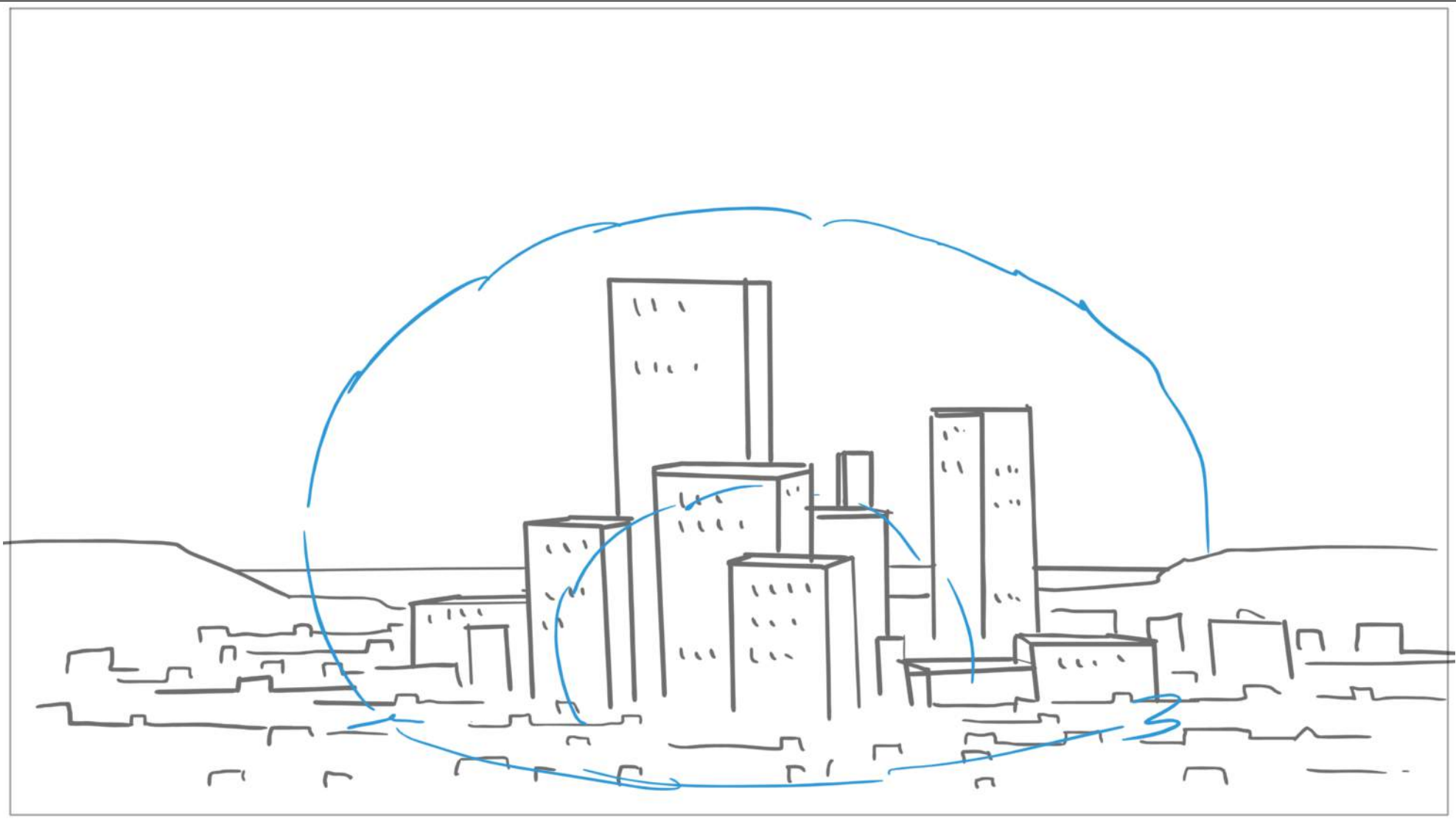

Scene	Duration	Panel	Duration
1	05:28:03	278	01:00

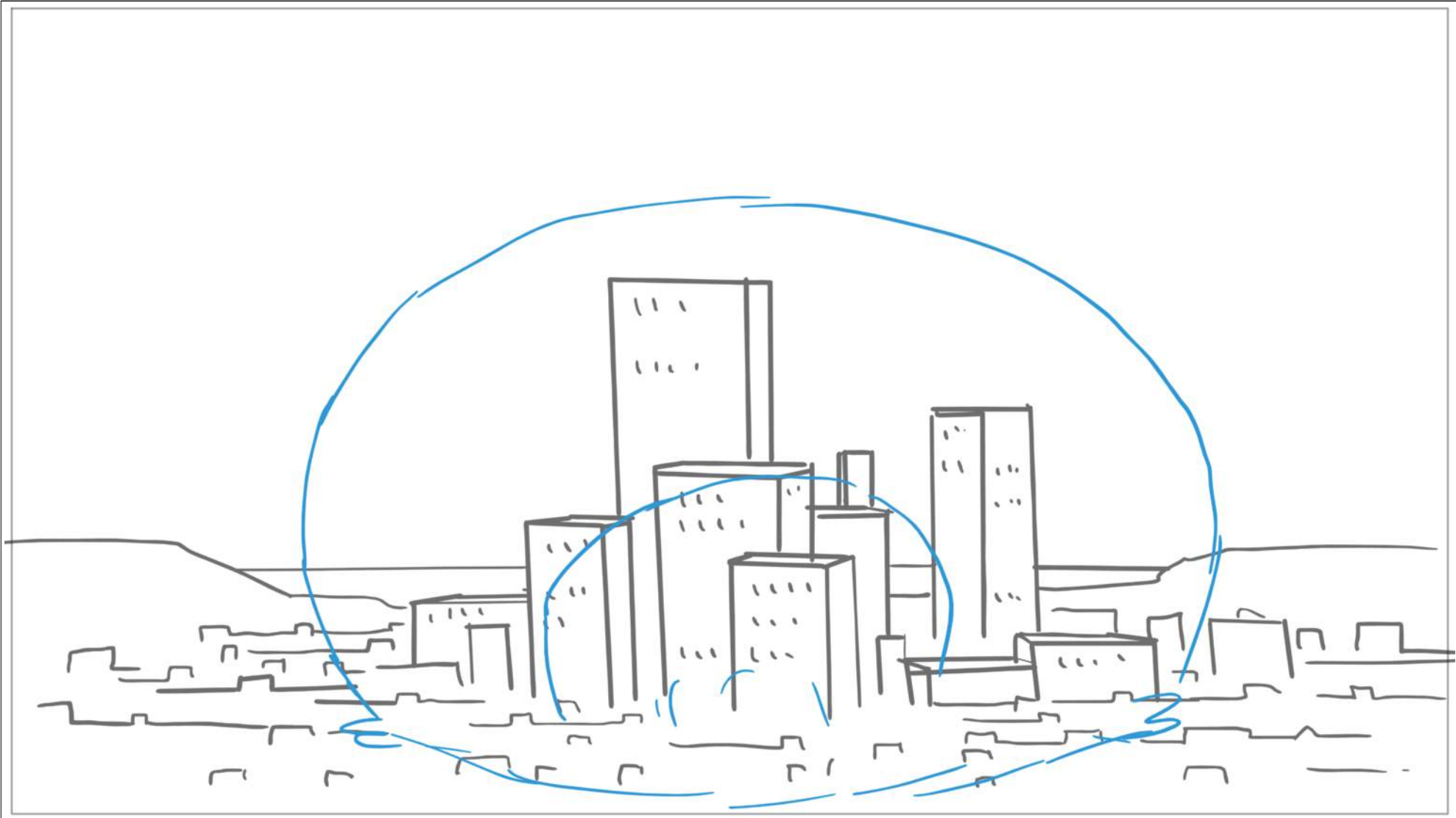

Scene	Duration	Panel	Duration
1	05:28:03	279	01:00

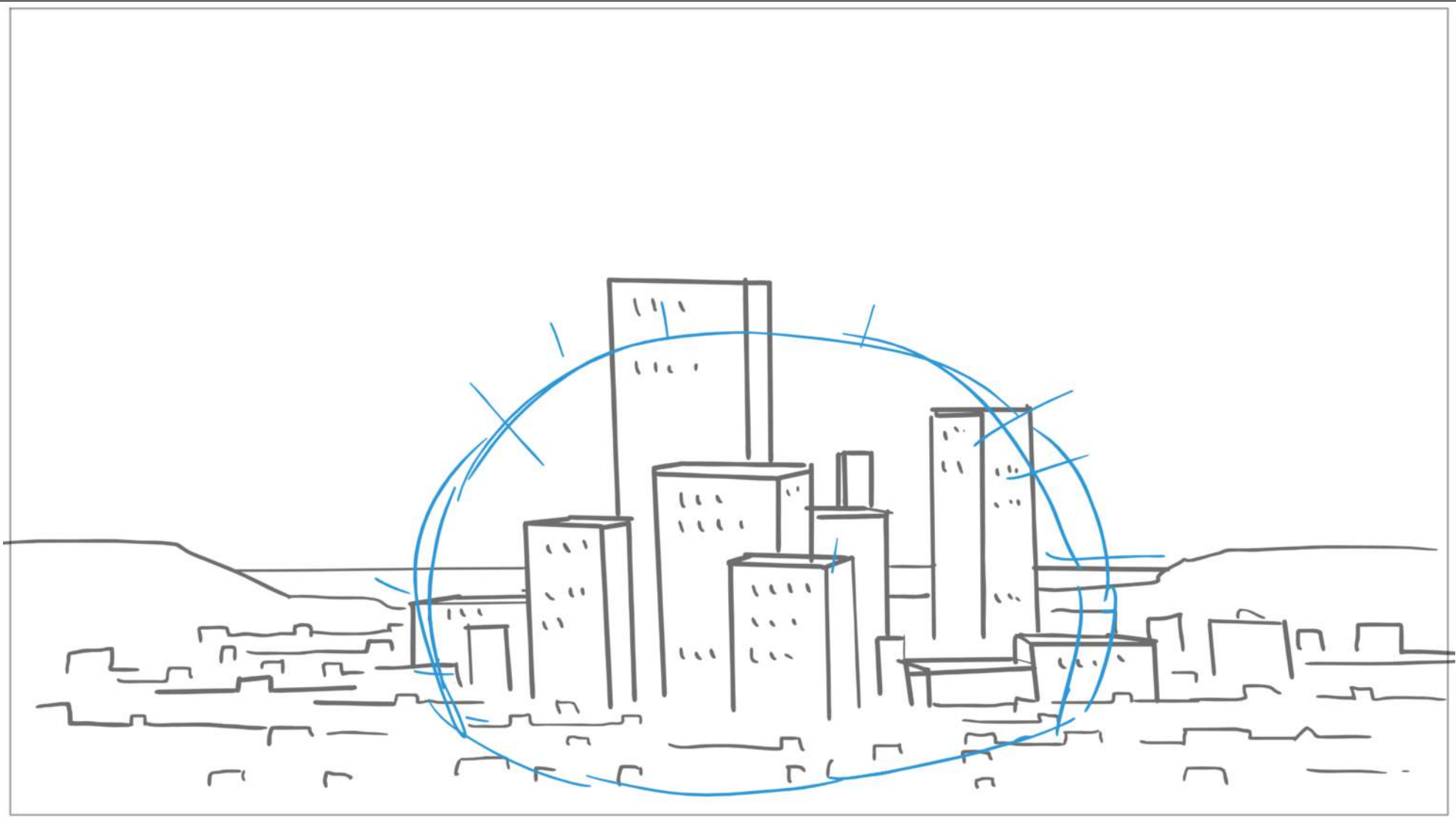

Scene	Duration	Panel	Duration
1	05:28:03	280	01:00

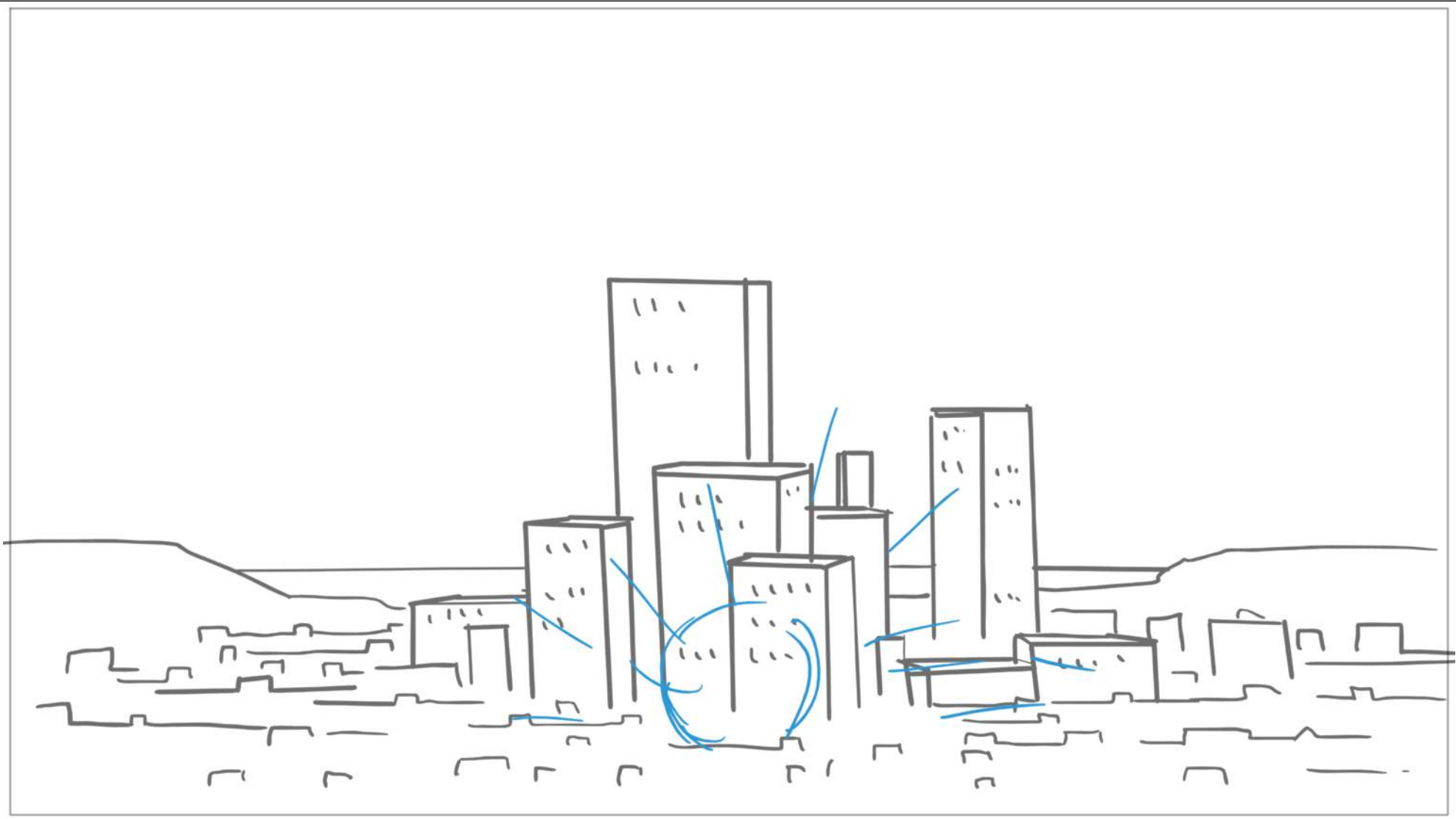

Scene	Duration	Panel	Duration
1	05:28:03	281	01:00

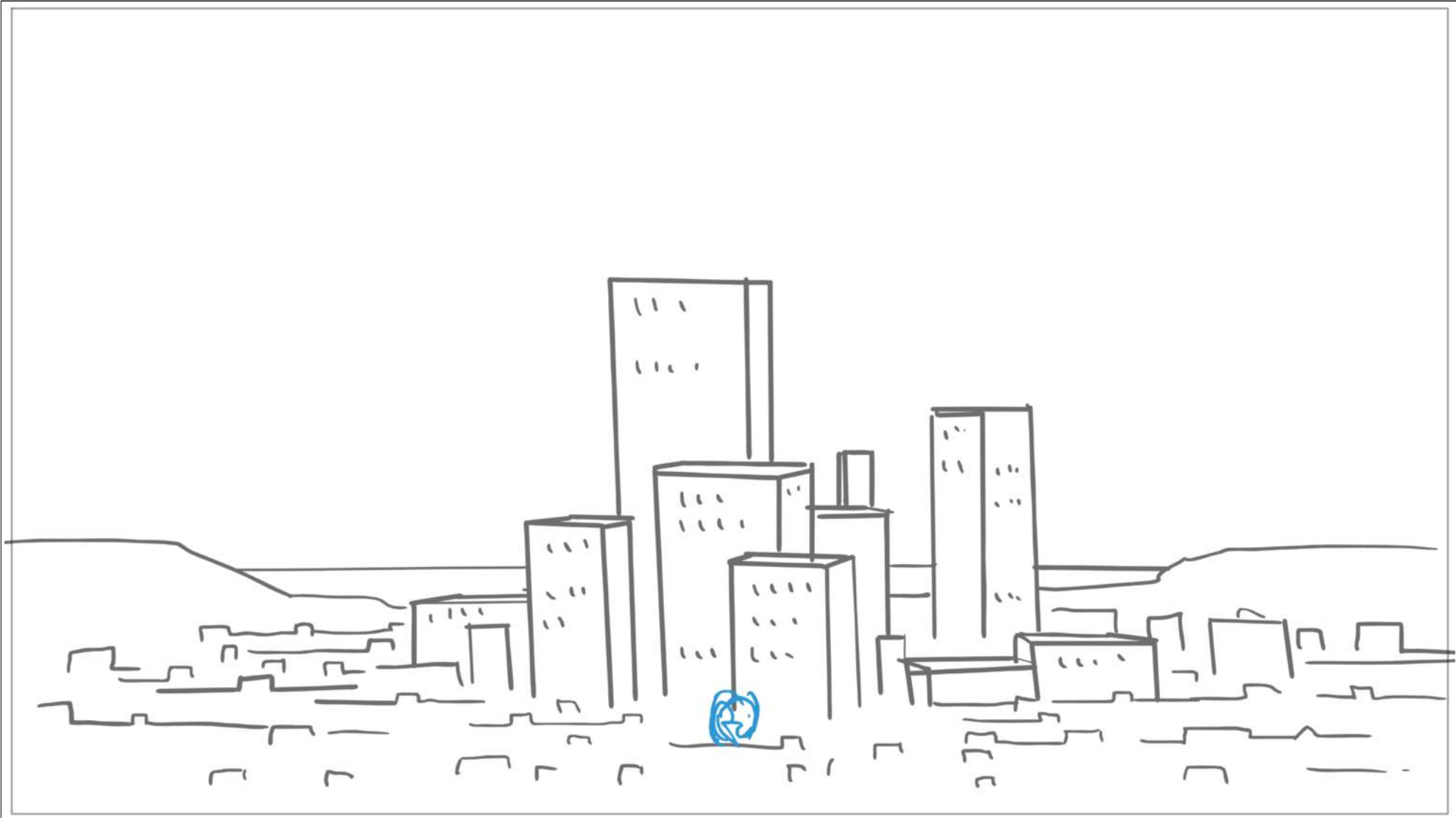

Scene	Duration	Panel	Duration
1	05:28:03	282	01:00

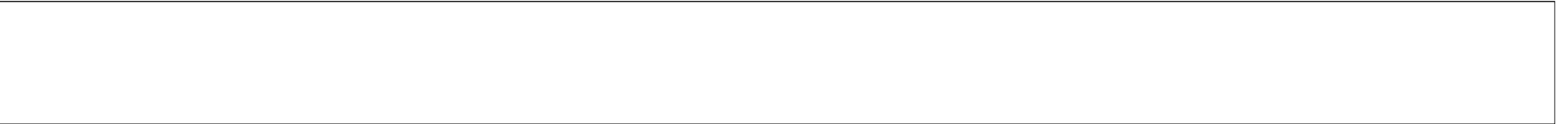
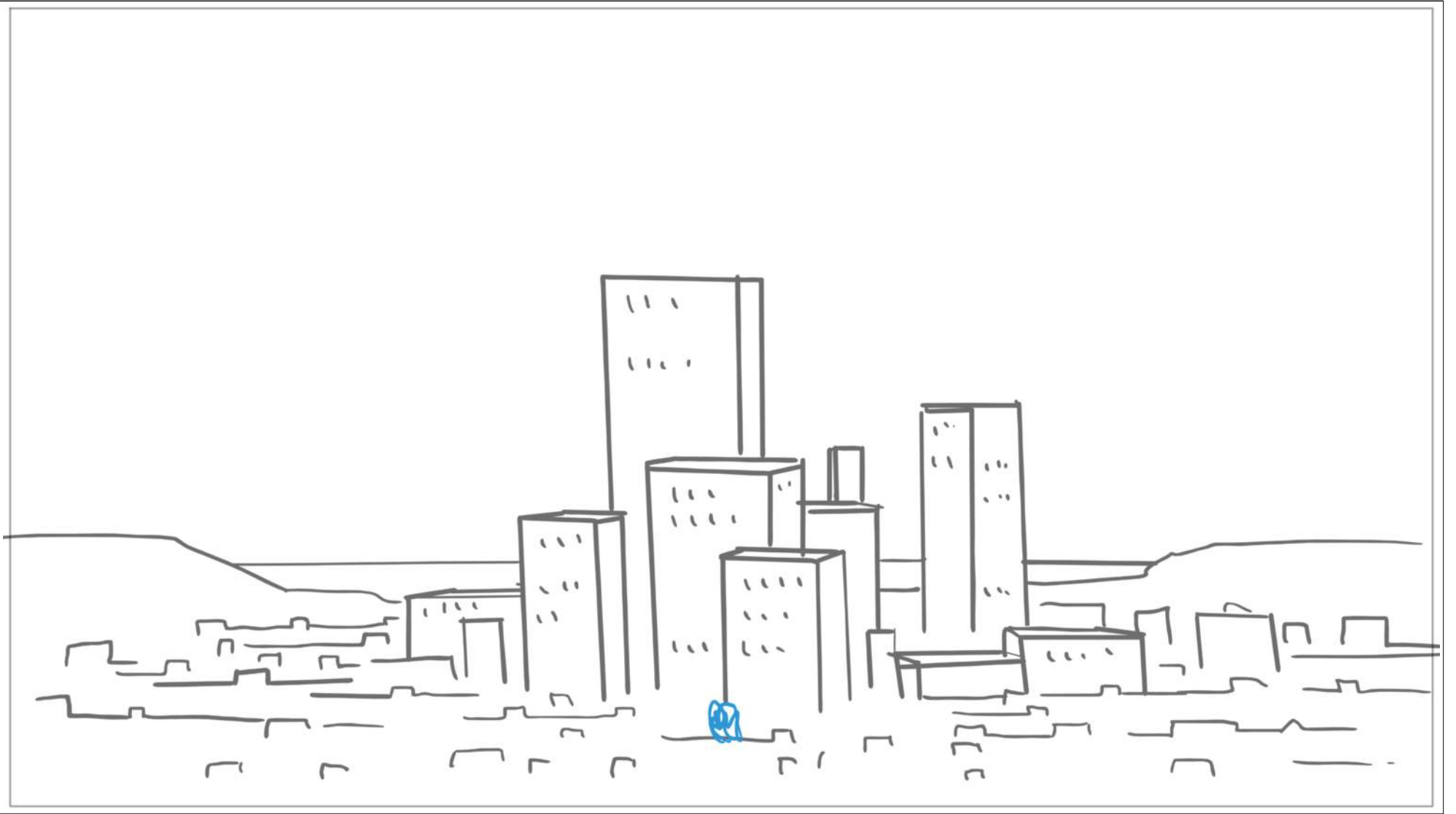

Scene	Duration	Panel	Duration
1	05:28:03	283	01:00



Scene	Duration	Panel	Duration
1	05:28:03	284	01:00

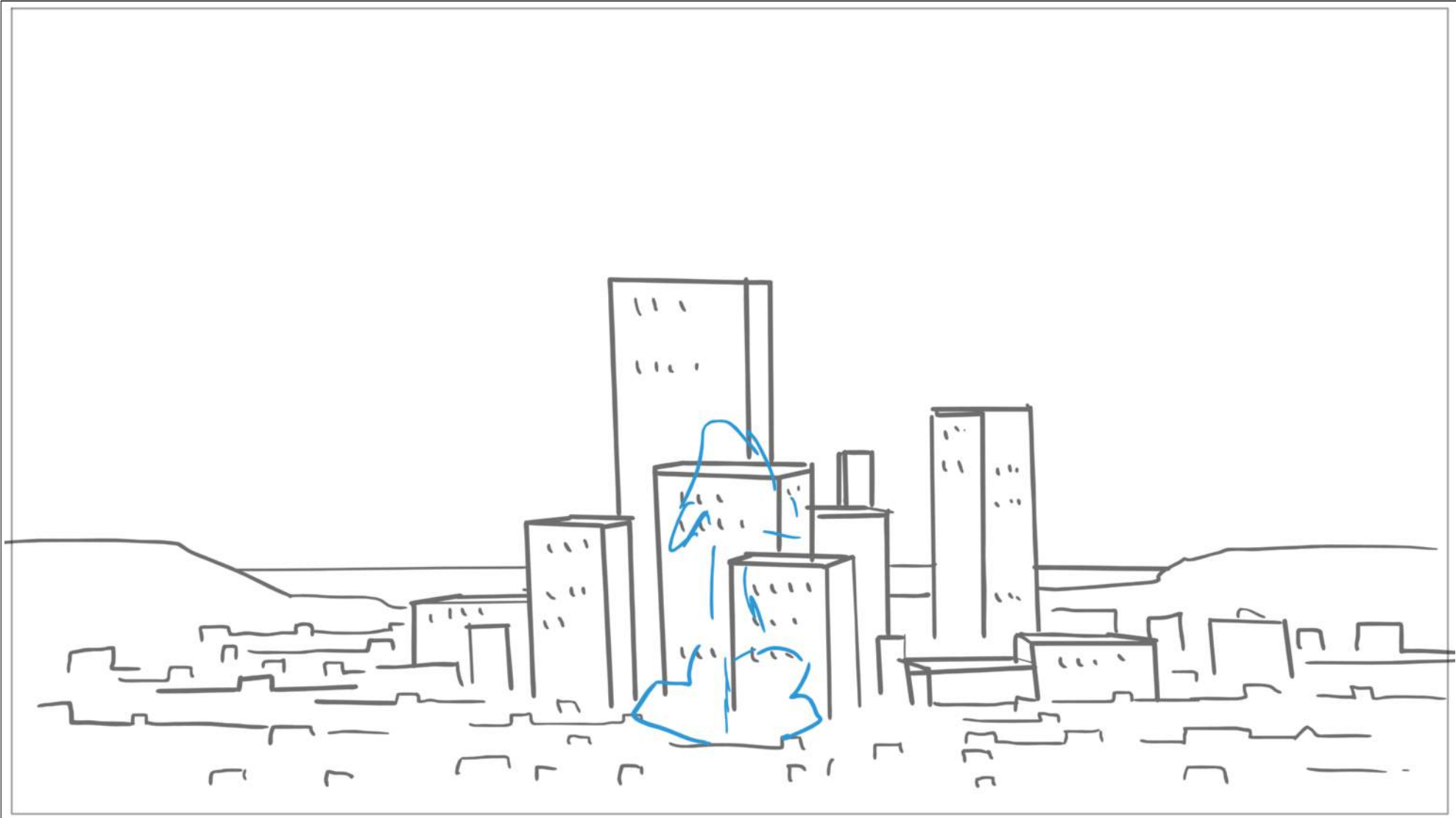

Scene	Duration	Panel	Duration
1	05:28:03	285	01:00

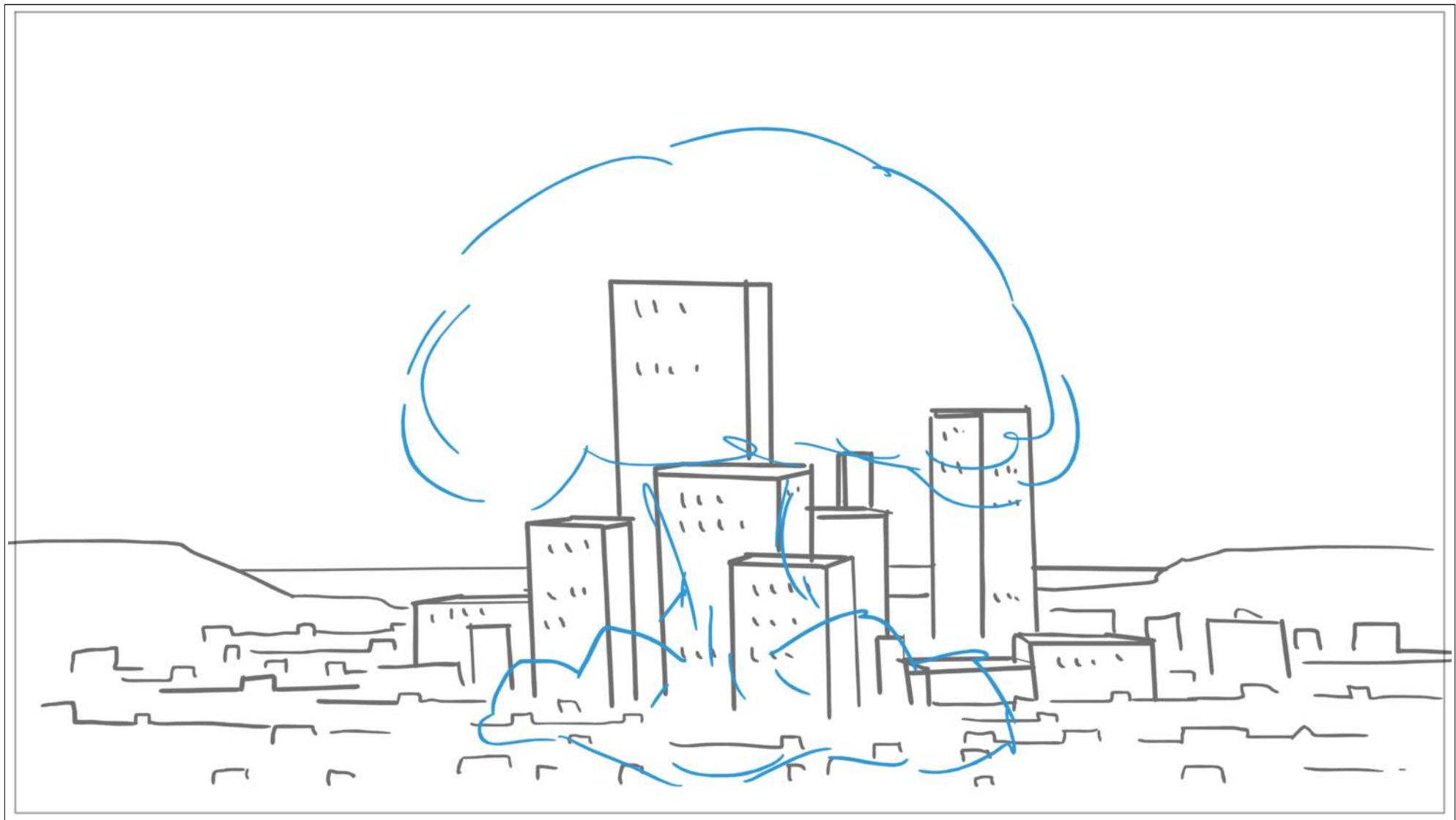

Scene	Duration	Panel	Duration
1	05:28:03	286	01:00

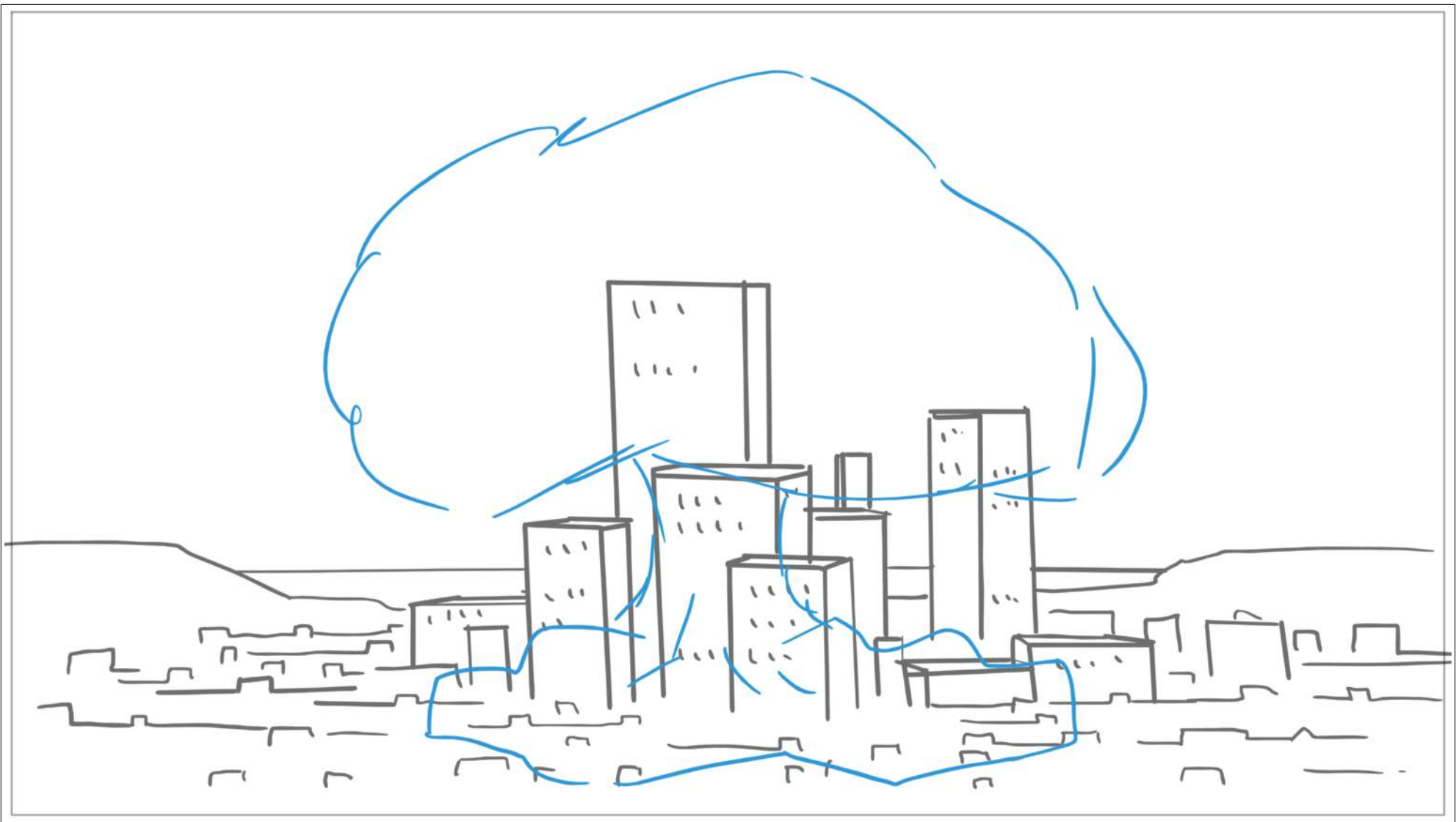

Scene	Duration	Panel	Duration
1	05:28:03	287	01:00

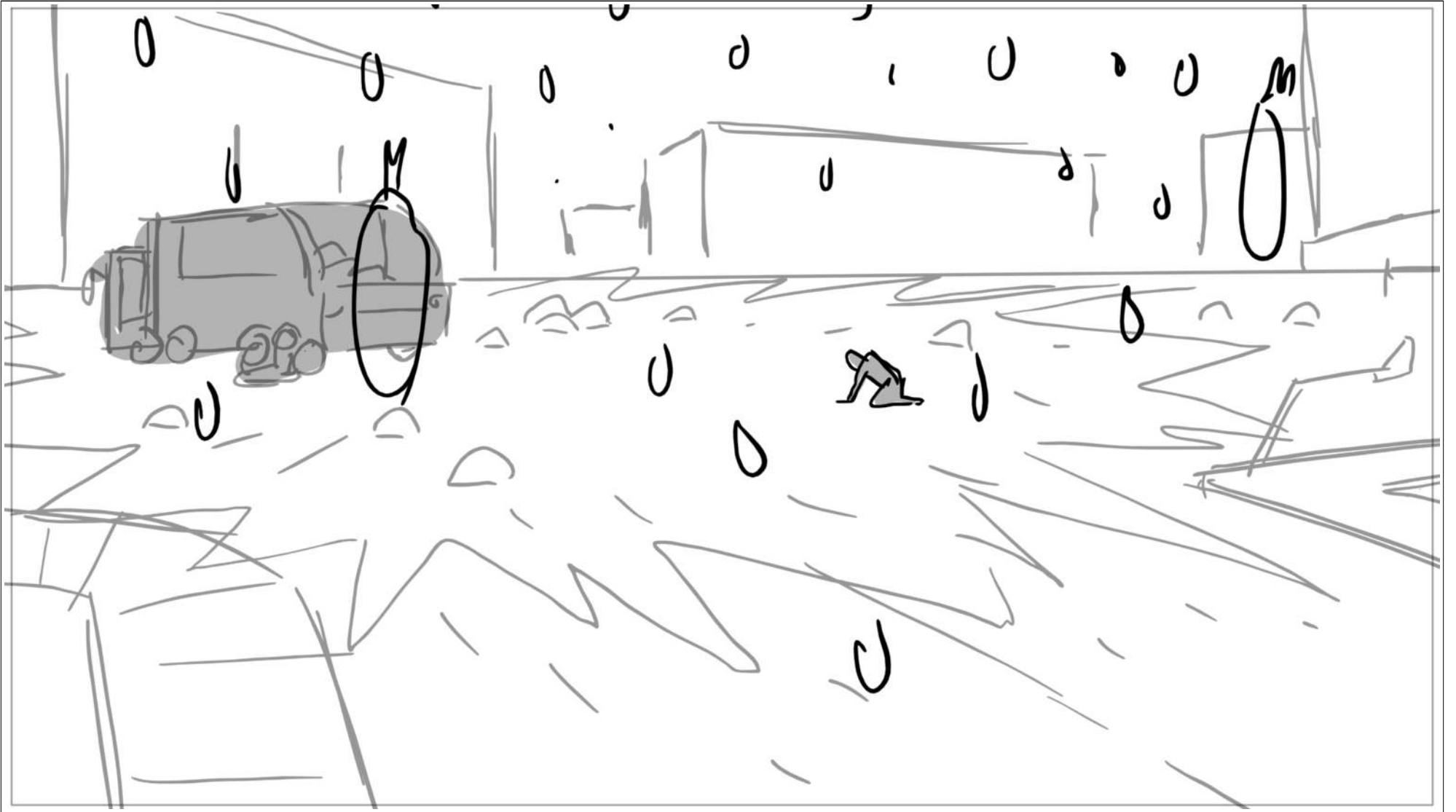

Scene	Duration	Panel	Duration
1	05:28:03	288	01:00

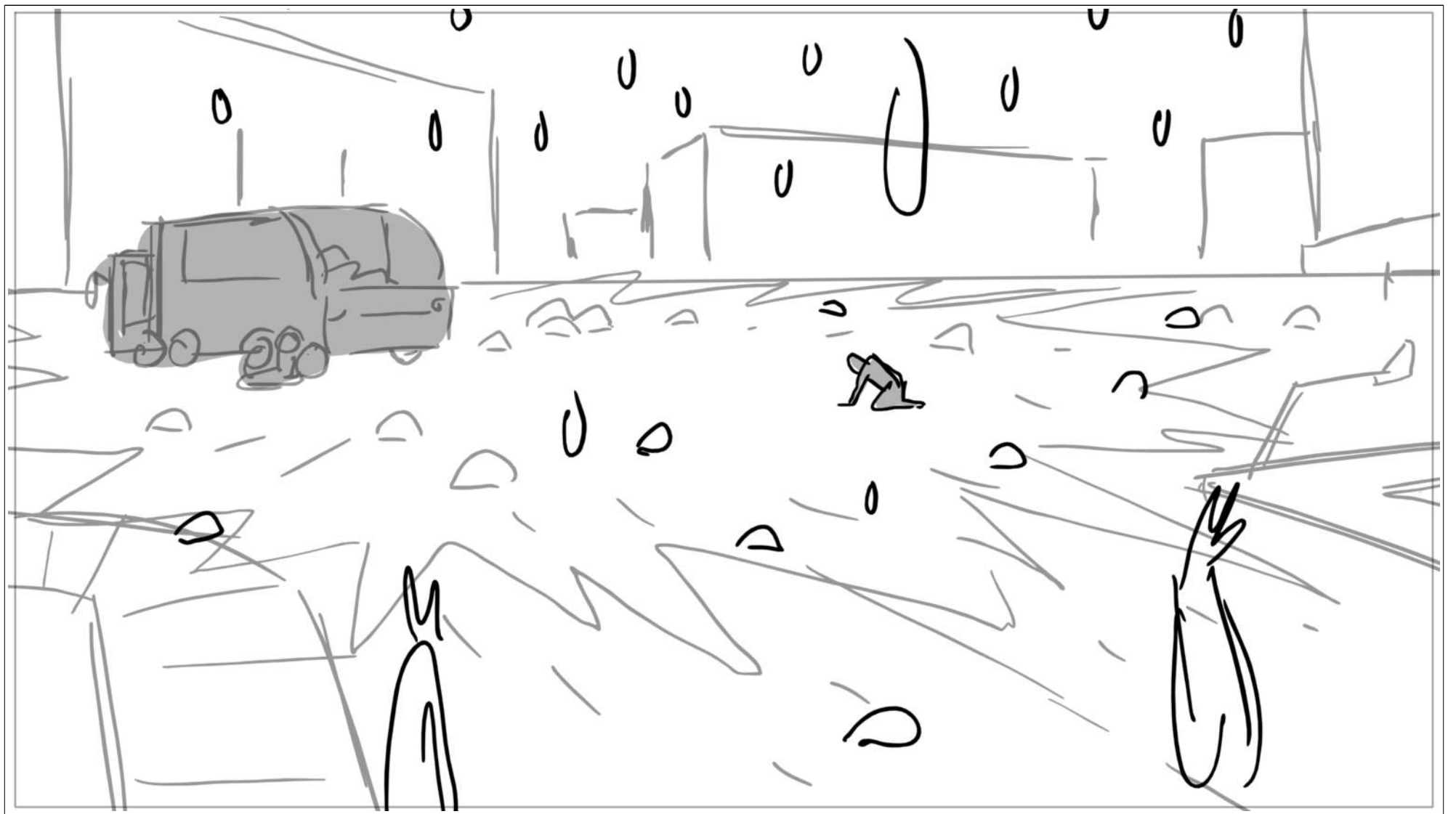

Scene	Duration	Panel	Duration
1	05:28:03	289	01:00

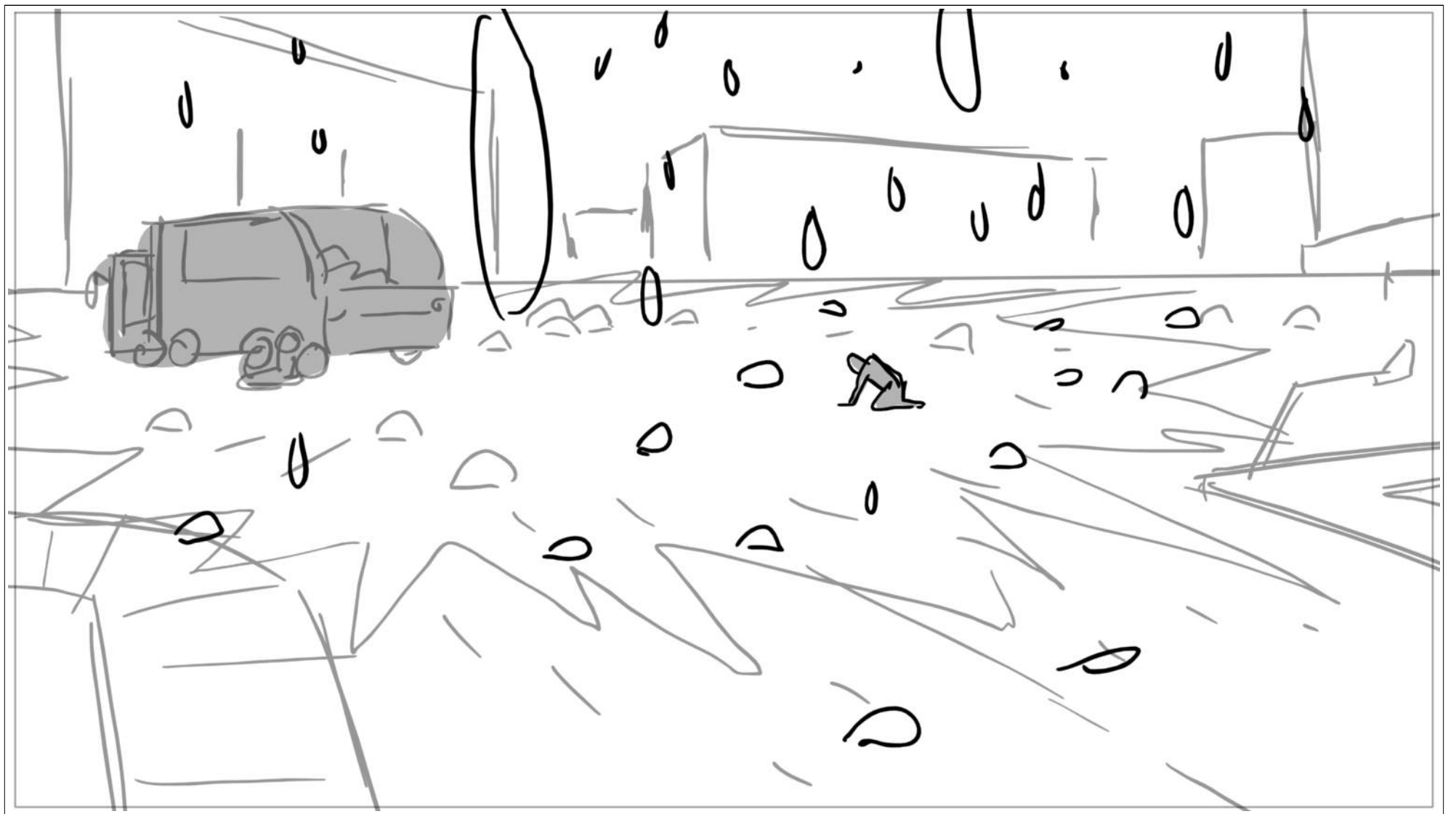

Scene	Duration	Panel	Duration
1	05:28:03	290	01:00

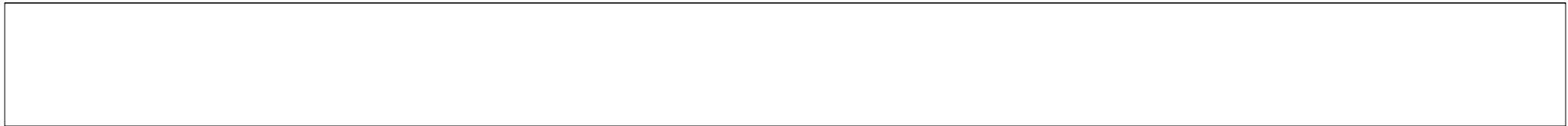

Scene	Duration	Panel	Duration
1	05:28:03	291	01:00

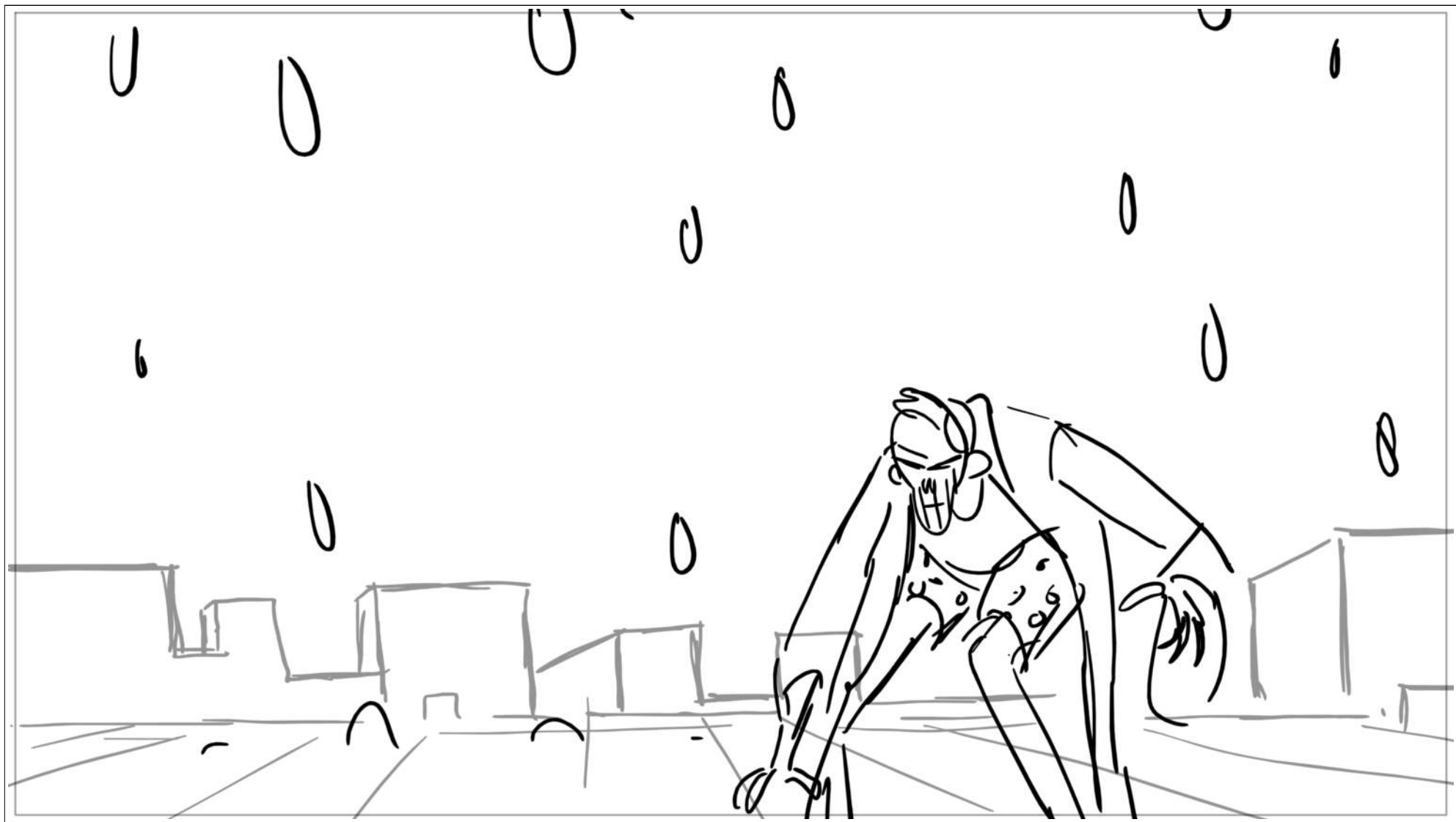

Scene	Duration	Panel	Duration
1	05:28:03	292	01:00

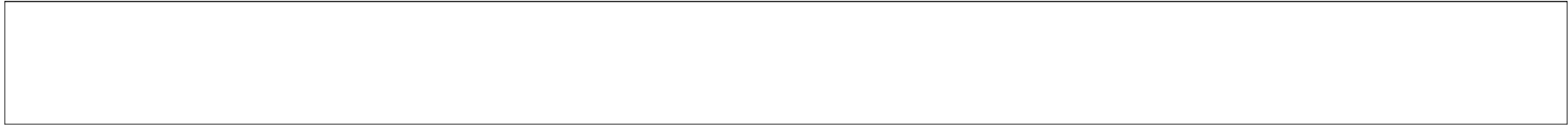

Scene	Duration	Panel	Duration
1	05:28:03	293	01:00



Scene	Duration	Panel	Duration
1	05:28:03	294	01:00

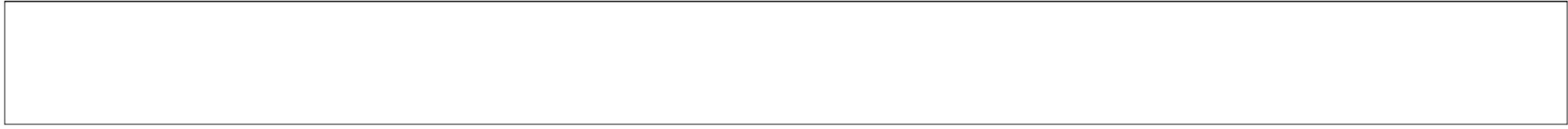

Scene	Duration	Panel	Duration
1	05:28:03	295	01:00



Scene	Duration	Panel	Duration
1	05:28:03	296	01:03

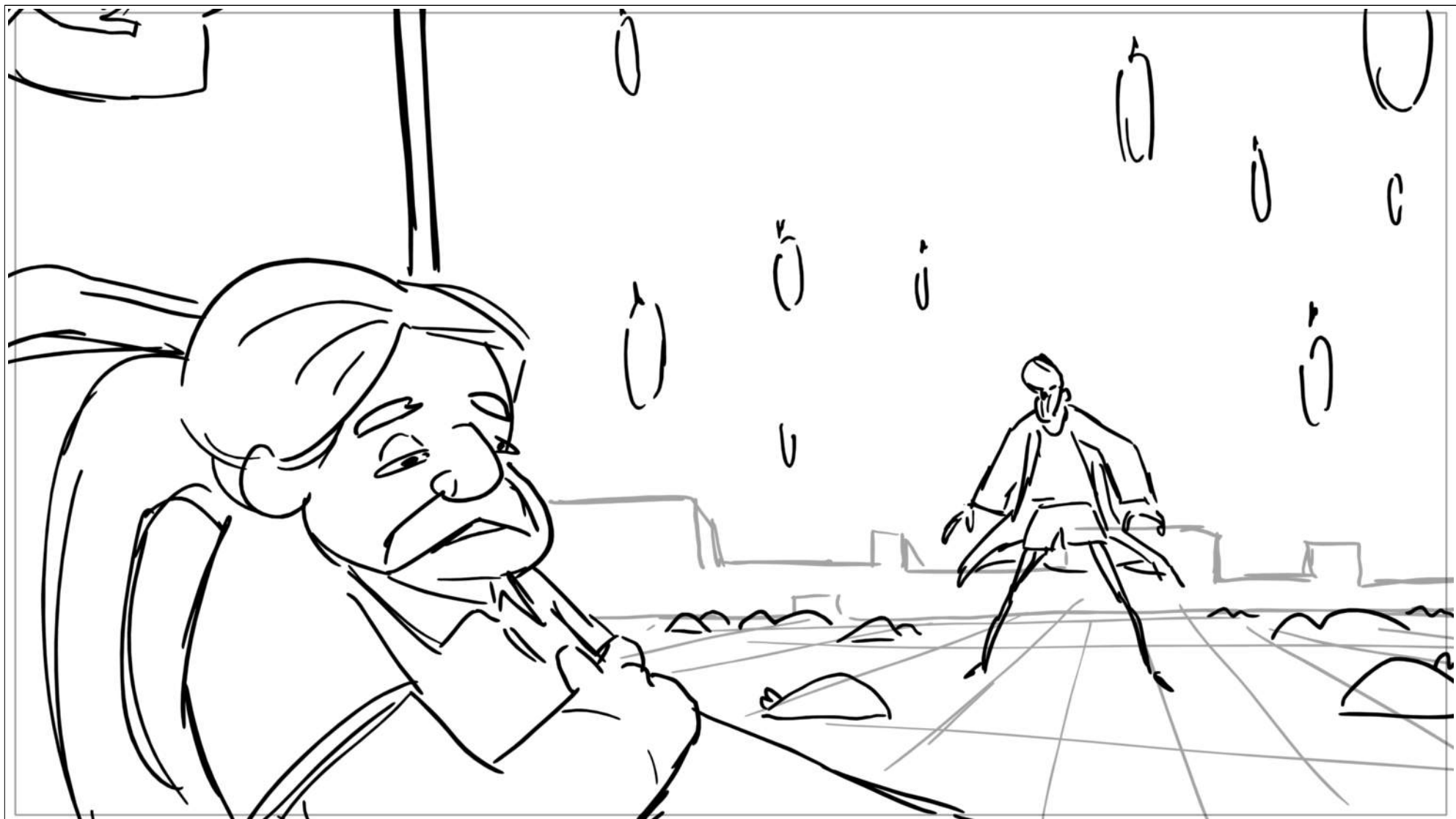

Scene	Duration	Panel	Duration
1	05:28:03	297	01:00

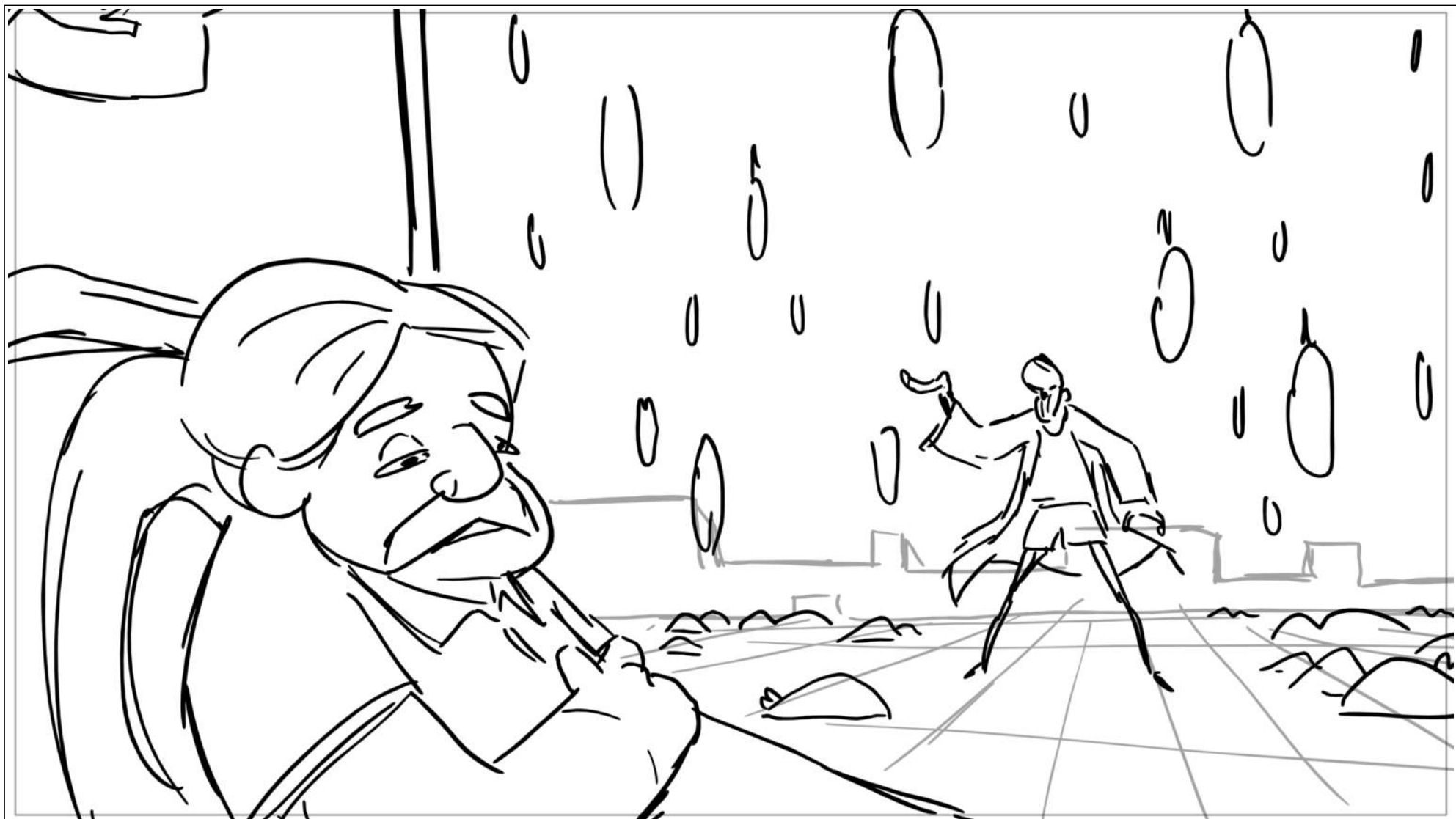

Scene	Duration	Panel	Duration
1	05:28:03	298	01:00

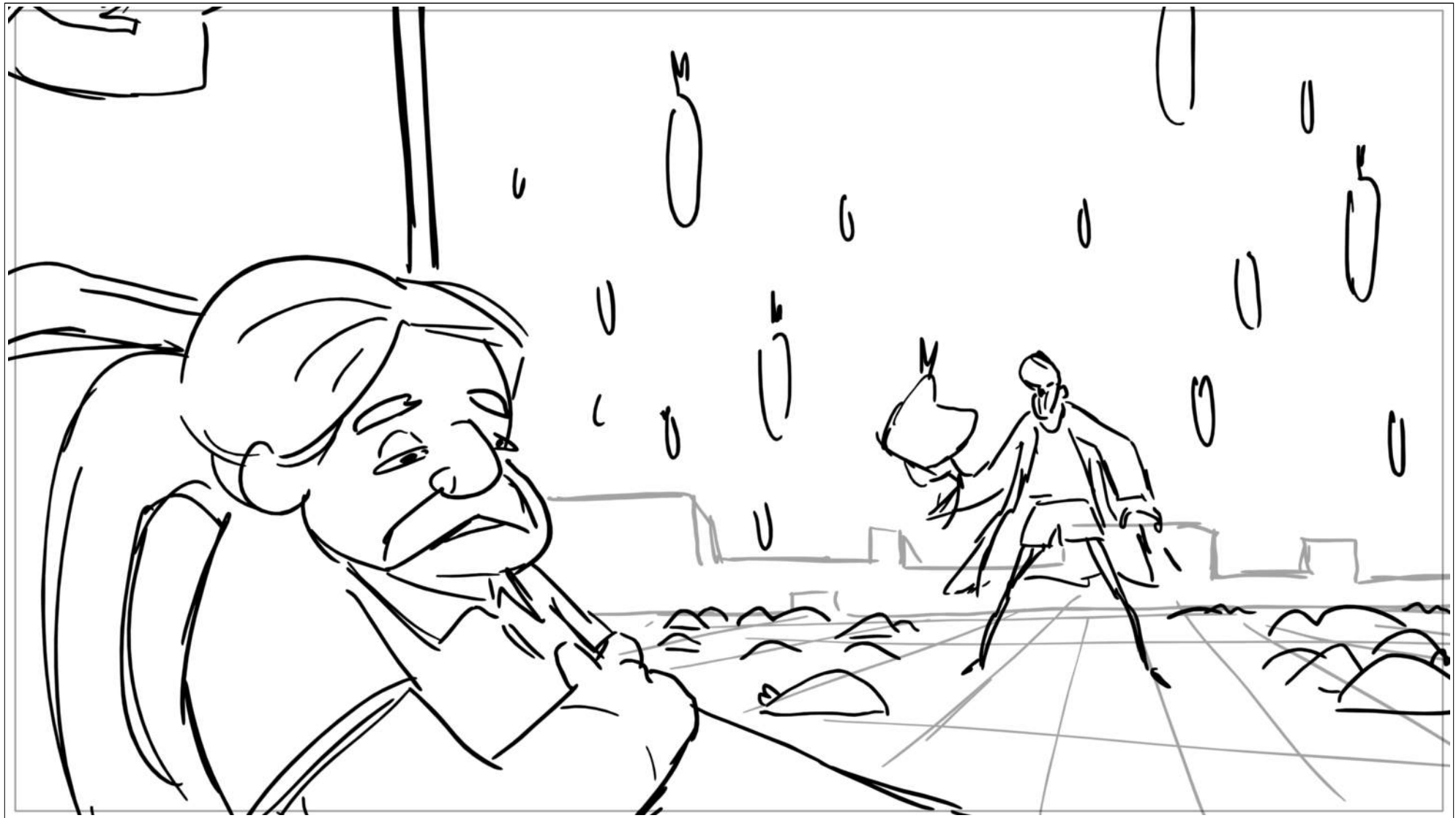

Scene	Duration	Panel	Duration
1	05:28:03	299	01:00

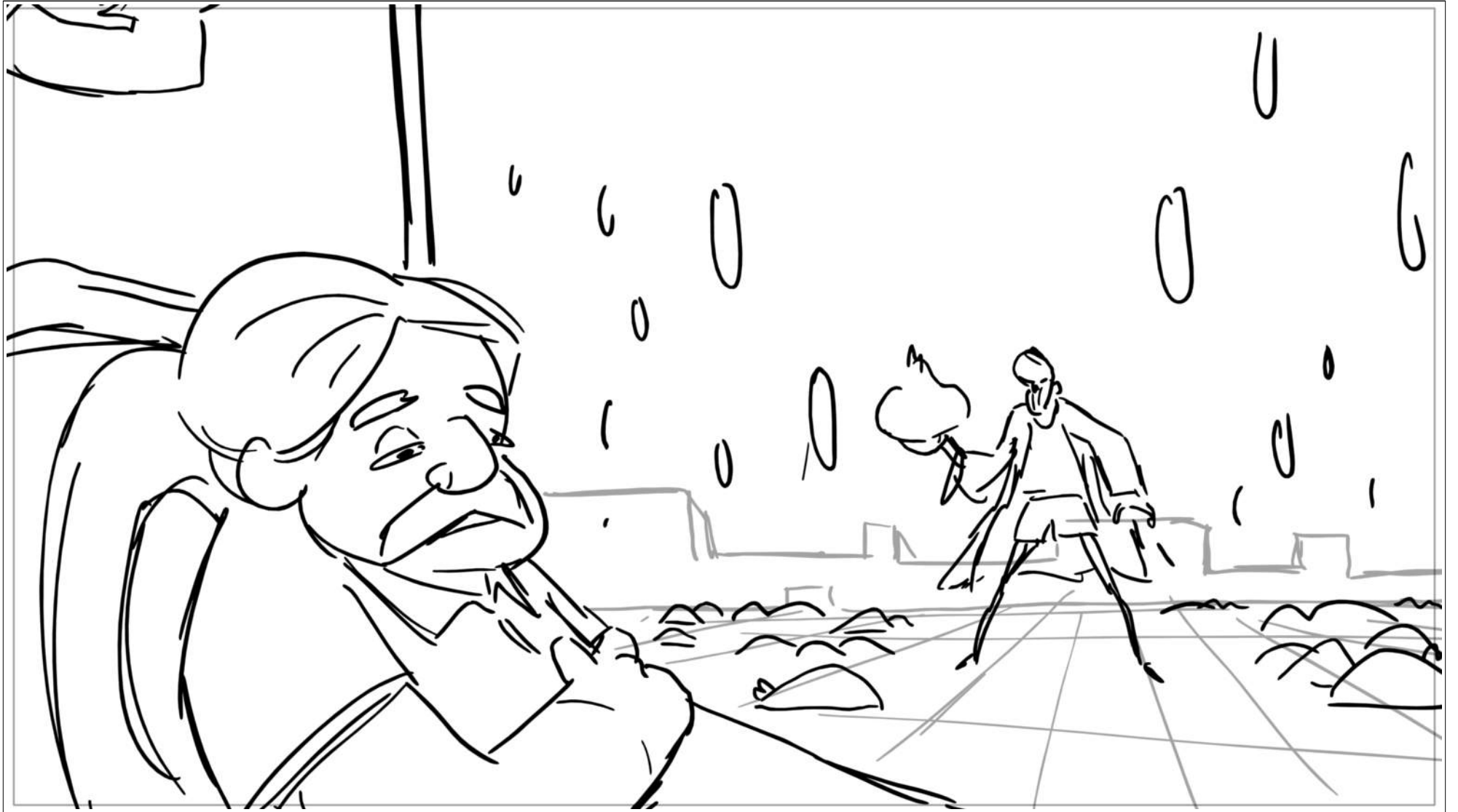

Scene	Duration	Panel	Duration
1	05:28:03	300	01:00

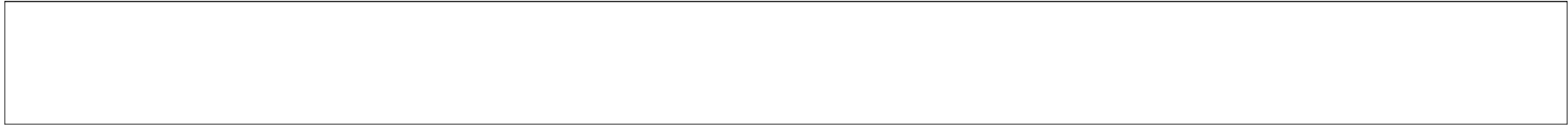
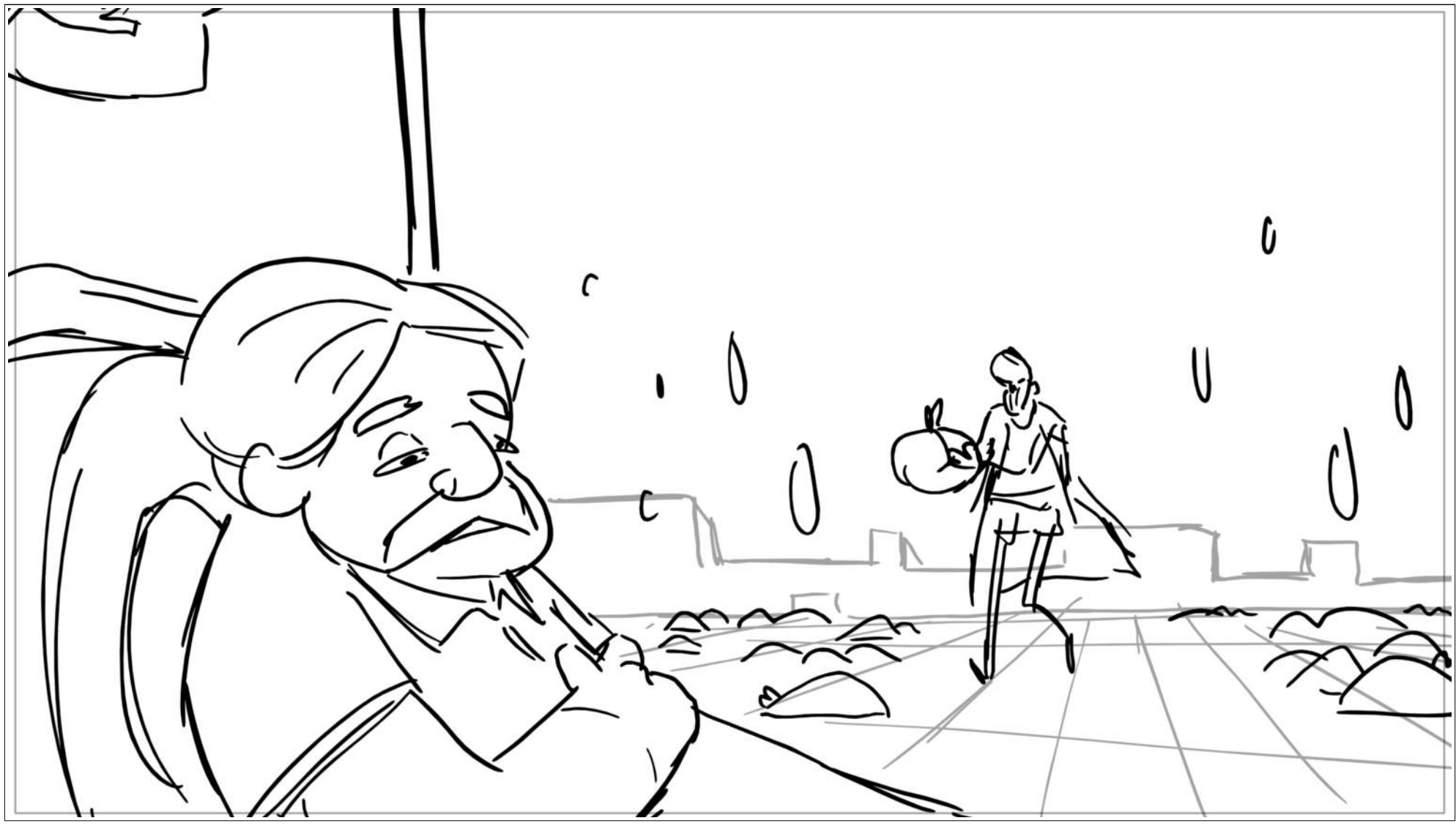

Scene	Duration	Panel	Duration
1	05:28:03	301	01:00



Scene	Duration	Panel	Duration
1	05:28:03	302	01:00

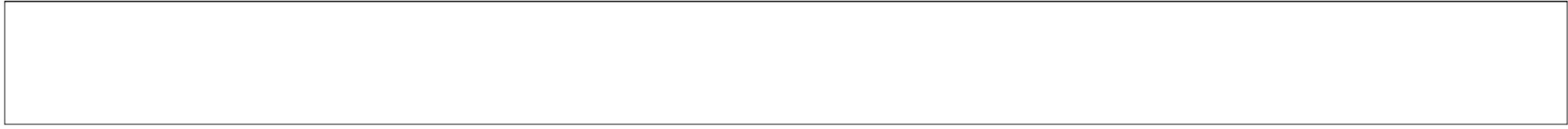

Scene	Duration	Panel	Duration
1	05:28:03	303	01:00

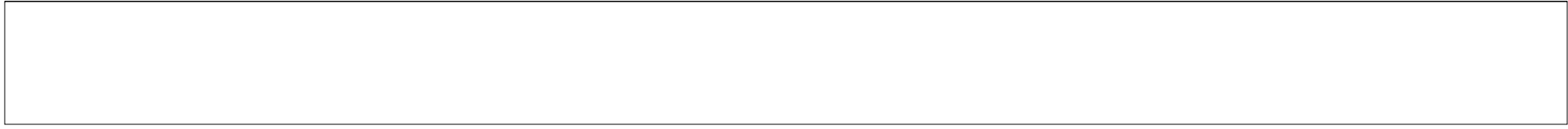

Scene	Duration	Panel	Duration
1	05:28:03	304	01:00



Scene	Duration	Panel	Duration
1	05:28:03	305	01:00



Scene	Duration	Panel	Duration
1	05:28:03	306	01:00



Scene	Duration	Panel	Duration
1	05:28:03	307	01:00



Scene	Duration	Panel	Duration
1	05:28:03	308	01:00

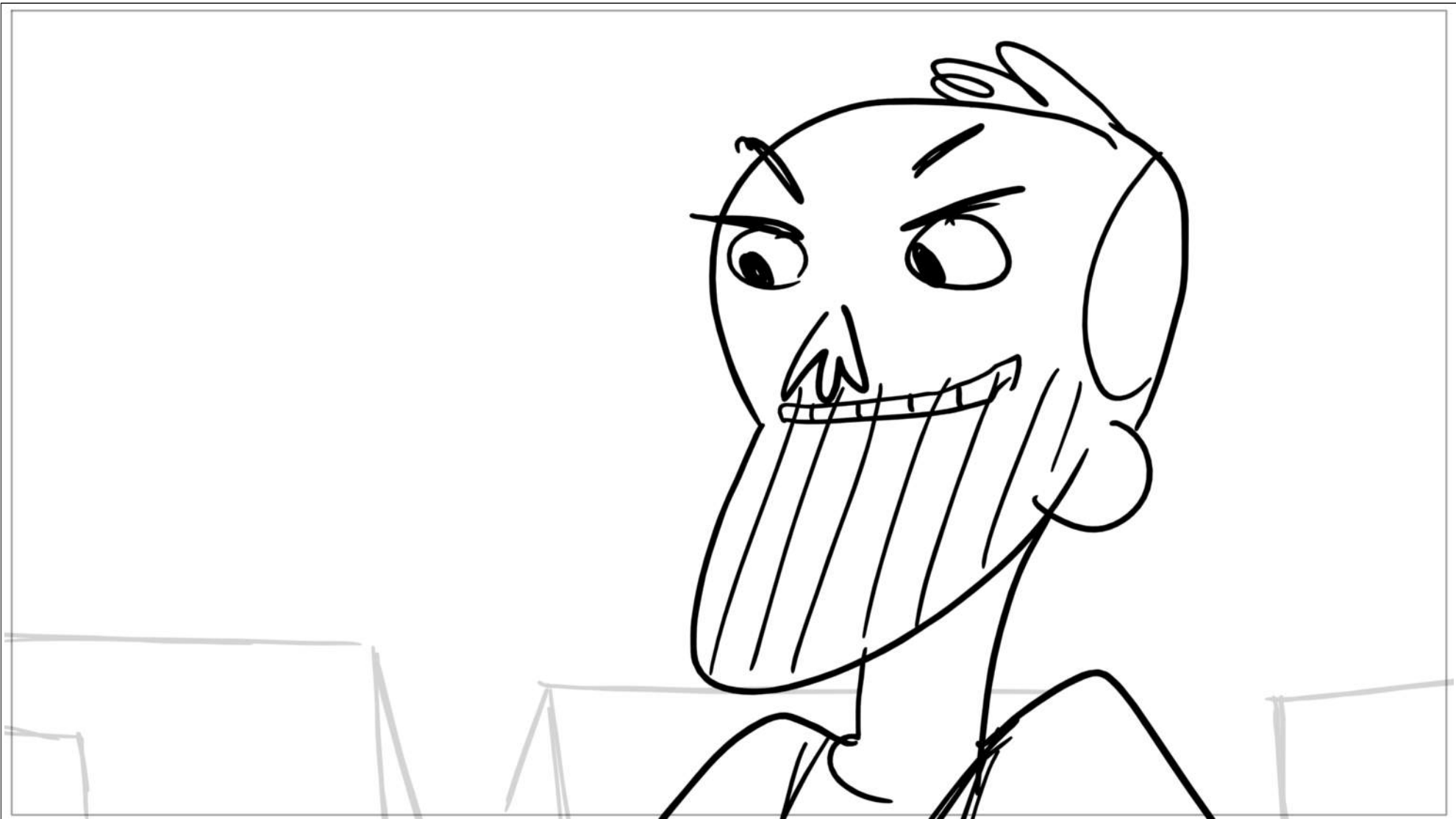

Scene	Duration	Panel	Duration
1	05:28:03	309	01:00

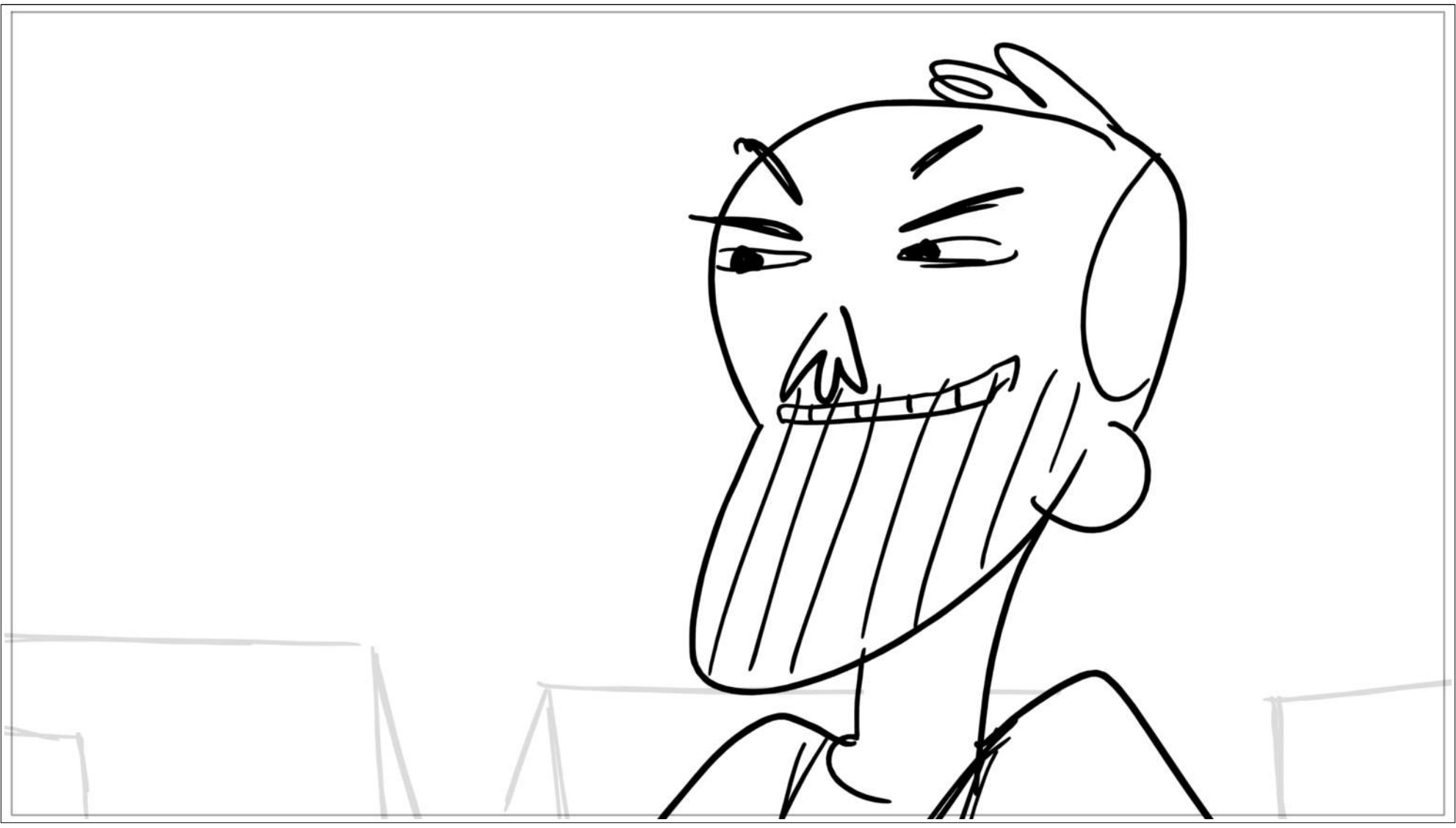

Scene	Duration	Panel	Duration
1	05:28:03	310	01:00



Scene	Duration	Panel	Duration
1	05:28:03	311	01:00



Scene	Duration	Panel	Duration
1	05:28:03	312	01:00



Scene	Duration	Panel	Duration
1	05:28:03	313	01:00



Scene	Duration	Panel	Duration
1	05:28:03	314	01:00



Scene	Duration	Panel	Duration
1	05:28:03	315	01:00



Scene	Duration	Panel	Duration
1	05:28:03	316	01:00



Scene	Duration	Panel	Duration
1	05:28:03	317	01:00



Scene	Duration	Panel	Duration
1	05:28:03	318	01:00



Scene	Duration	Panel	Duration
1	05:28:03	319	01:00

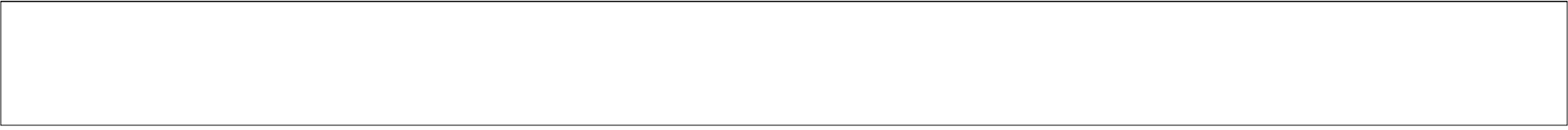
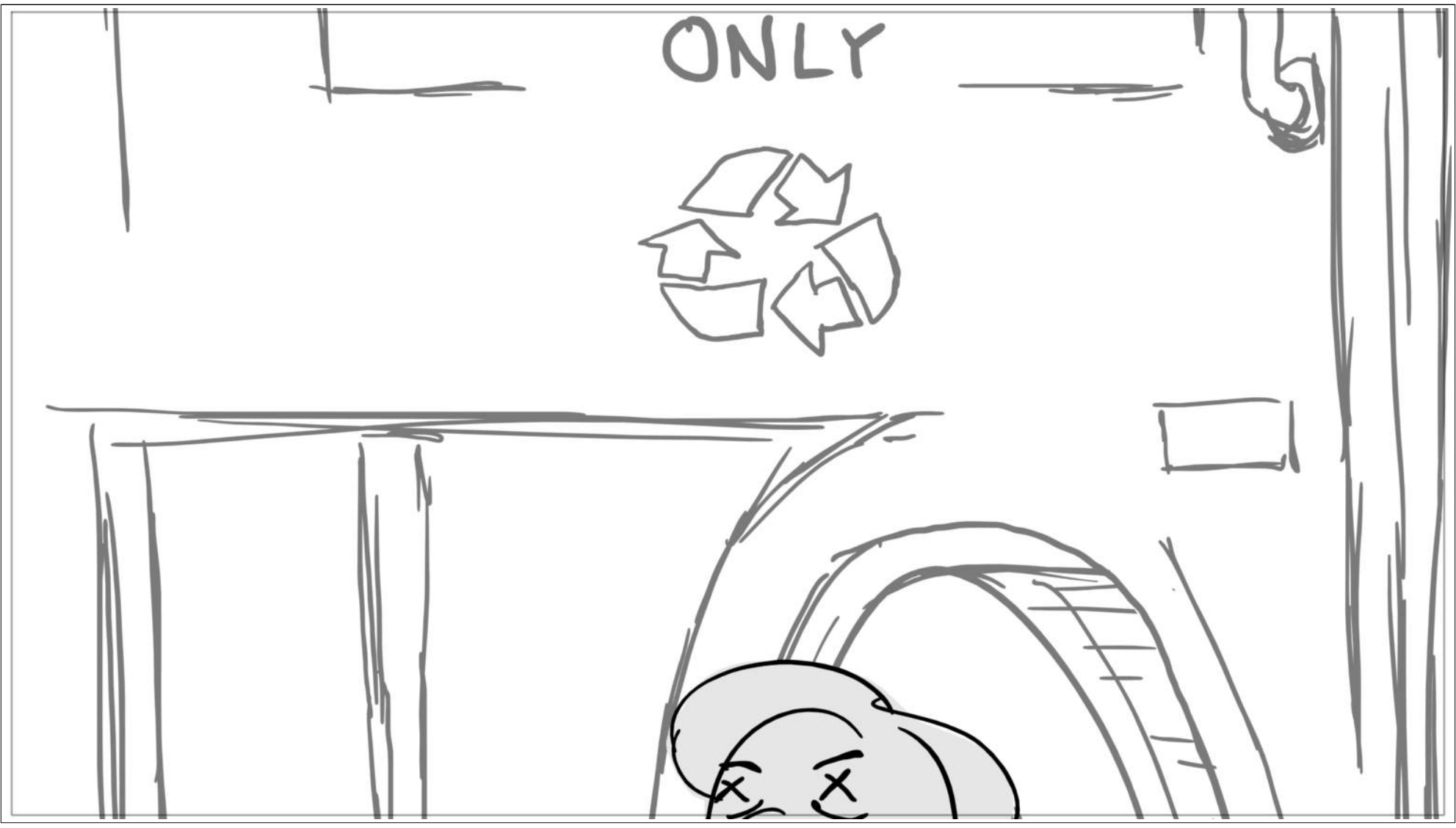

Scene	Duration	Panel	Duration
1	05:28:03	320	01:00

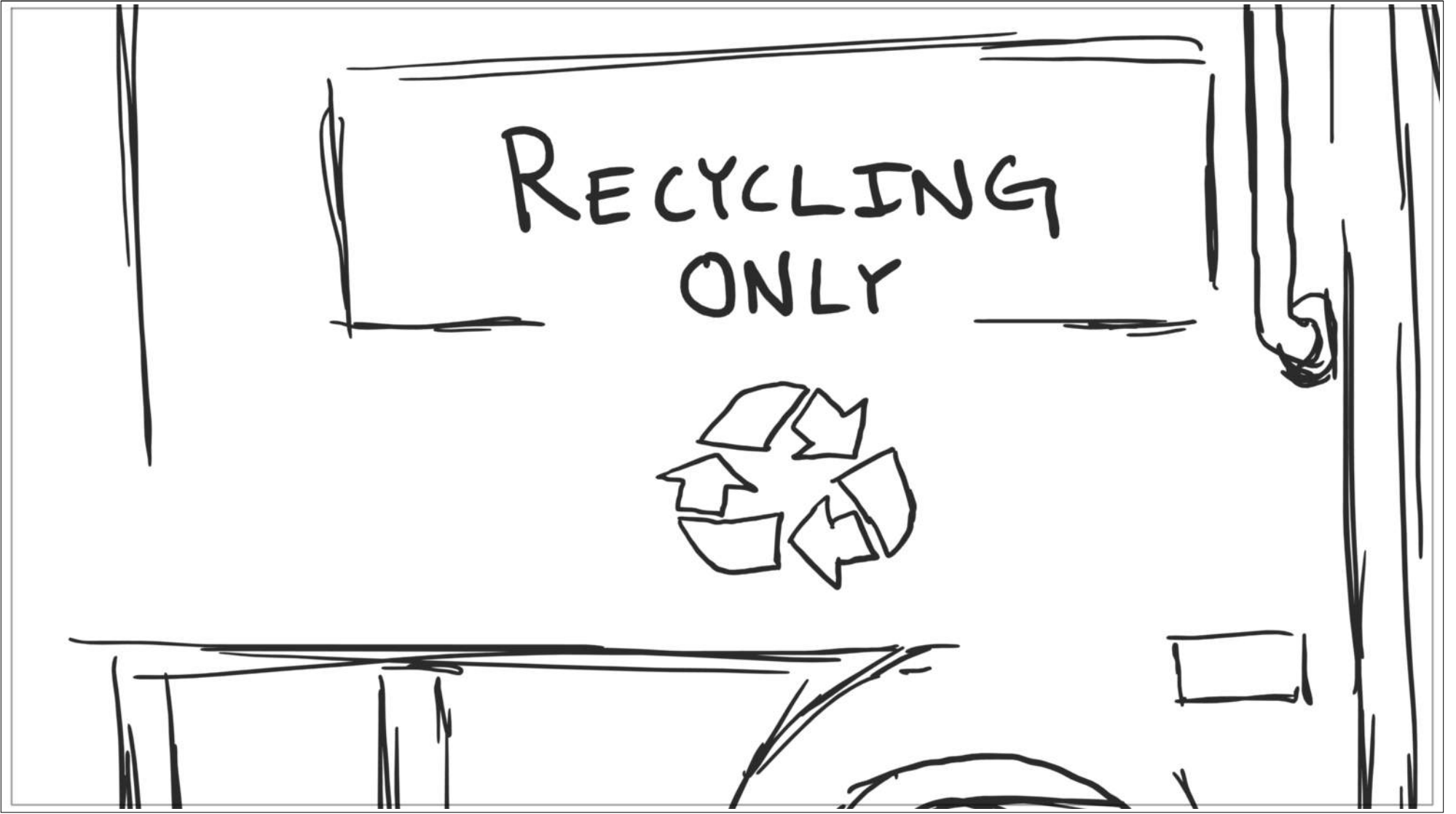

Scene	Duration	Panel	Duration
1	05:28:03	321	01:00

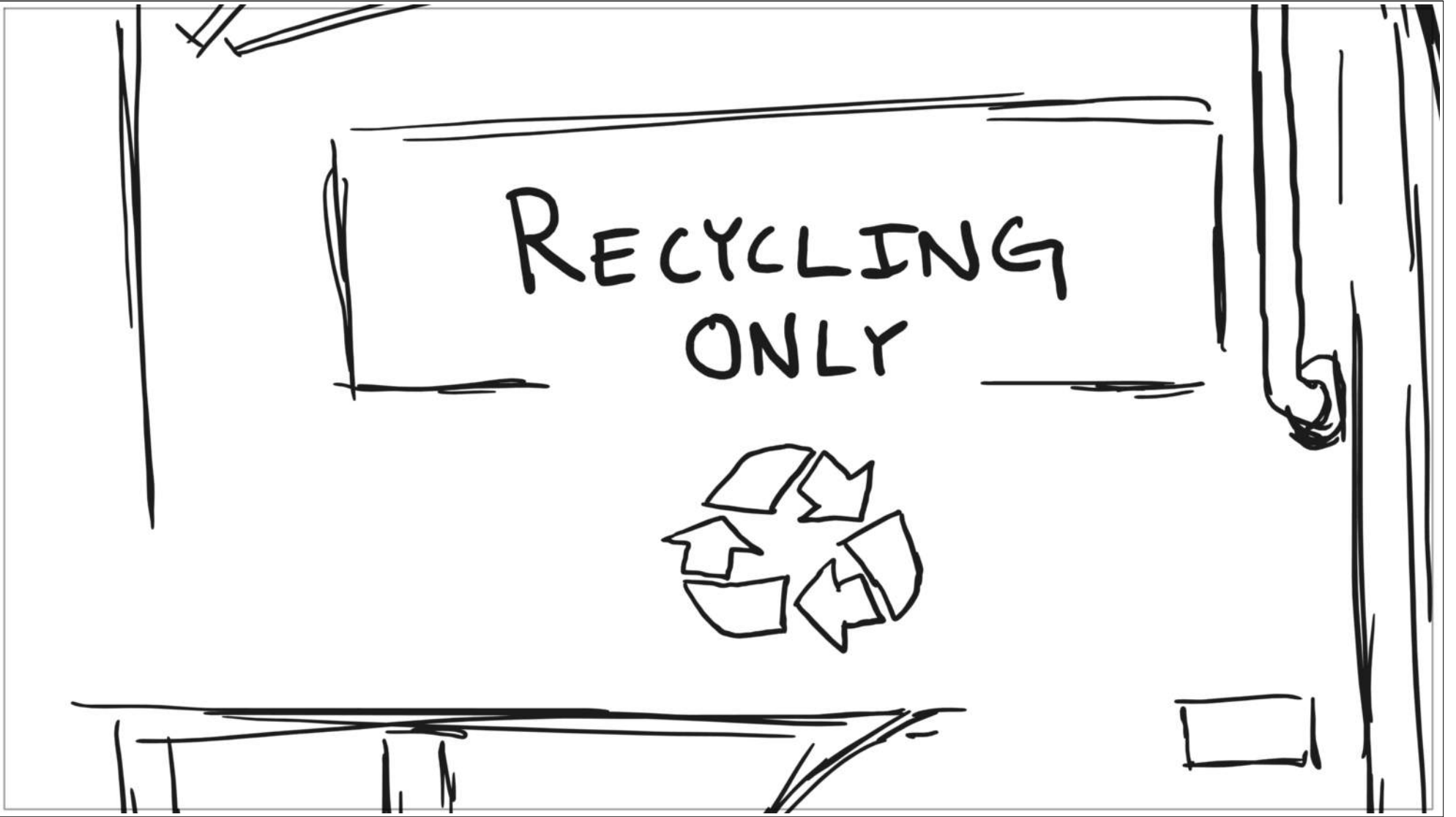

Scene	Duration	Panel	Duration
1	05:28:03	322	01:00

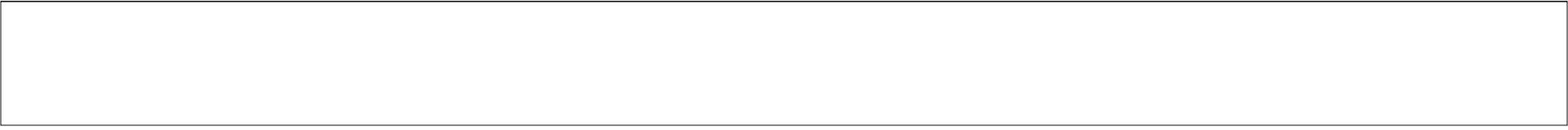

Scene	Duration	Panel	Duration
1	05:28:03	323	01:00

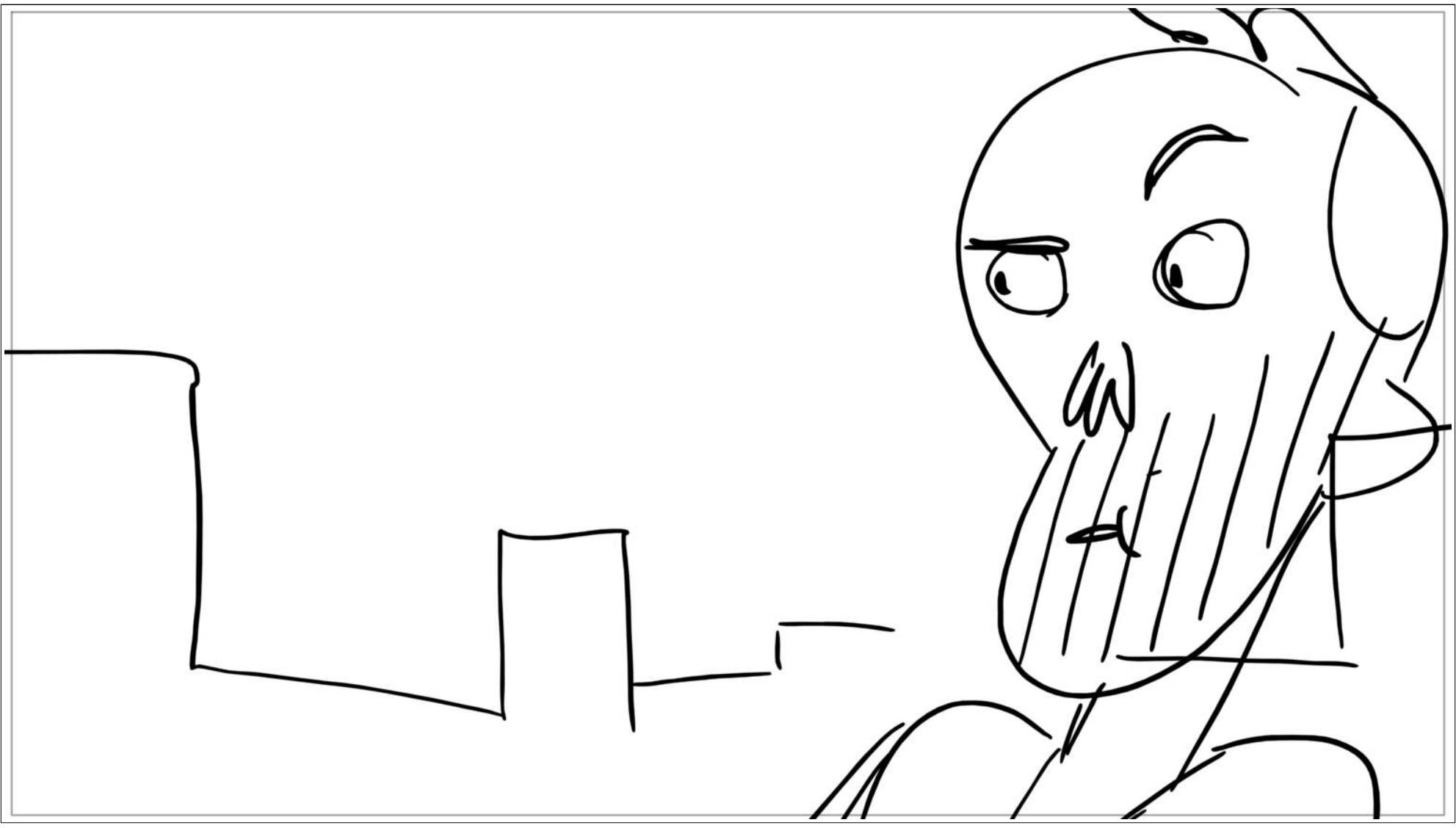

Scene	Duration	Panel	Duration
1	05:28:03	324	01:00



Scene	Duration	Panel	Duration
1	05:28:03	325	01:00



Scene	Duration	Panel	Duration
1	05:28:03	326	01:00



Scene	Duration	Panel	Duration
1	05:28:03	327	01:00



Scene	Duration	Panel	Duration
1	05:28:03	328	01:00

